

HOUSE OF ROHL.

PRESENTS

EMTEK®



DOOR HARDWARE PRICE BOOK

Prices Effective January 31, 2025



HOUSE OF ROHL

PRESENTS

THE STORY OF A LIFE WELL CRAFTED™

We believe distinctive stories are what make life exceptional.

At House of Rohl®,
A portfolio of luxury décor brands,
we pursue the discovery of time-honored craft
that opens the door to stories unlike any other.

Stories of place and provenance.
Stories of dedication and passion.
Stories of artistry and heritage.

Through our collection of brands, you will find storied details that bring
endless curated design possibilities.
And the closer you look, the more you will see the details of your own story.

The Story of a Life Well Crafted.

Riobel

PERRIN & ROWE®
LONDON



victoria ⊕ albert®

ROHL

Schaub

EMTEK

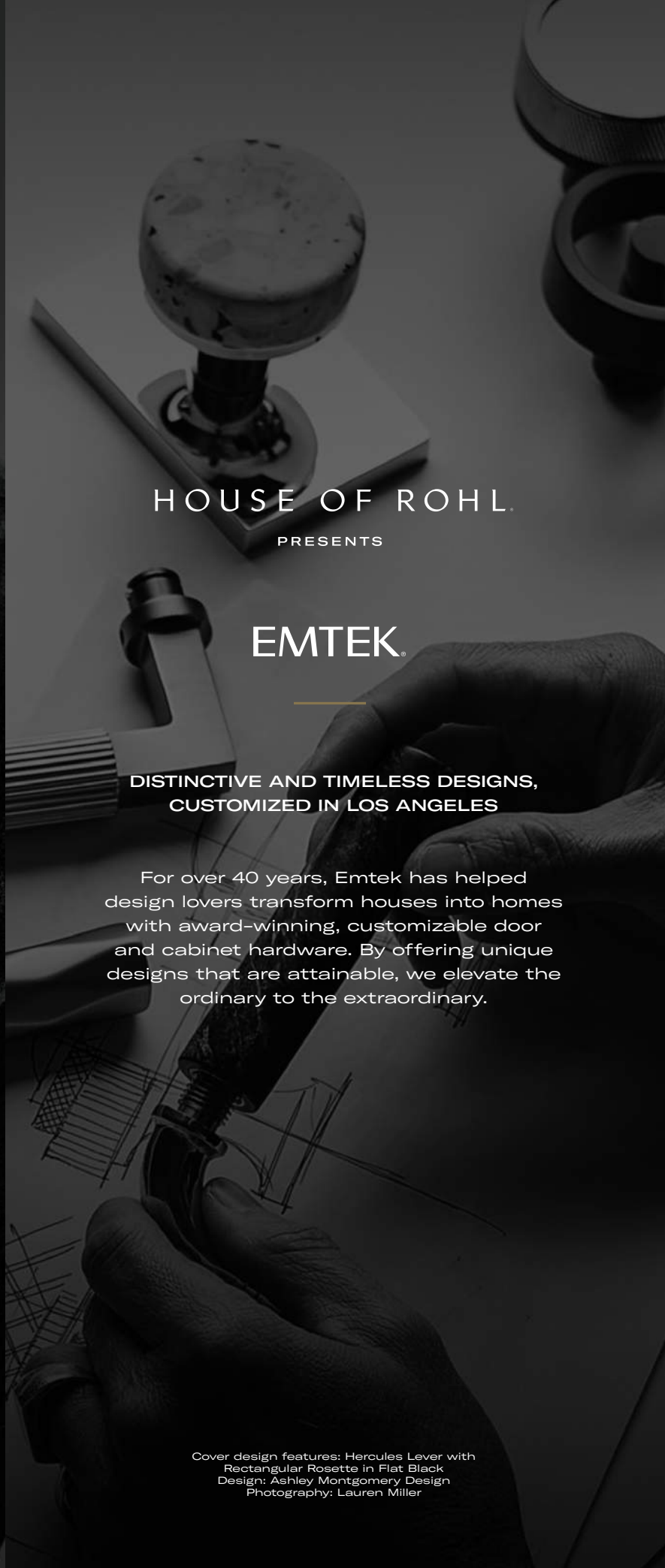

HOUSE OF ROHL.

PRESENTS

EMTEK.

**DISTINCTIVE AND TIMELESS DESIGNS,
CUSTOMIZED IN LOS ANGELES**

For over 40 years, Emtek has helped design lovers transform houses into homes with award-winning, customizable door and cabinet hardware. By offering unique designs that are attainable, we elevate the ordinary to the extraordinary.

Cover design features: Hercules Lever with
Rectangular Rosette in Flat Black
Design: Ashley Montgomery Design
Photography: Lauren Miller

WHAT'S NEW

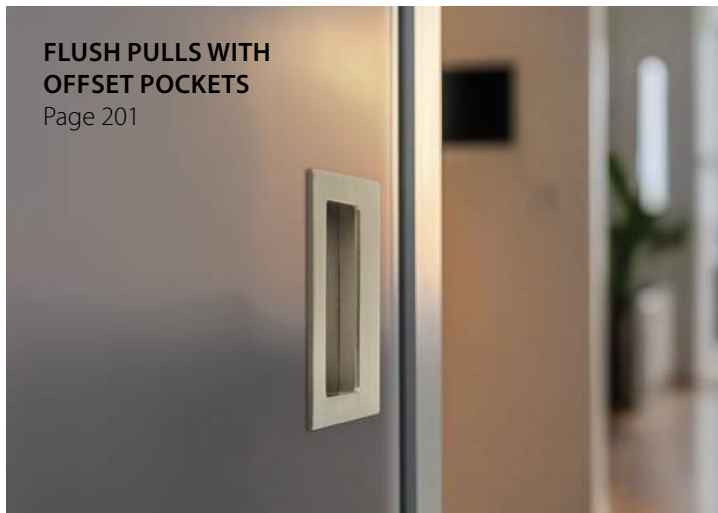

ELECTRONIC LOCKSETS

EMPowered™ 2	28
Electronic Keypad Entrance Handlesets, Deadbolts, Leversets	38

ENTRY SETS

Mortise Entrance Handlesets	42
Mortise Knob by Knob, Lever by Lever Entrance Locksets	59
Tubular Entrance Handlesets	64
Grip by Grip Entrance Handlesets	85
Key in Lever & Key in Knob Locksets	86

SINGLE AND TWO-POINT LOCKSETS

Brass Single and Two-Point Locksets	92
-------------------------------------	----

DEADBOLTS

Single Cylinder, Double Cylinder Deadbolts	95
Single Sided Deadbolts	102

SIDEPLATE LOCKSETS

Keyed and Non-Keyed Sideplate Locksets	104
Thumbturn Privacy Sideplate Locksets	118

STRETTO NARROW TRIM LOCKSETS

STRETTO Narrow Trim Locksets	119
STRETTO Narrow Trim Passage & Privacy Sets	126

PASSAGE & PRIVACY SETS

Interior Mortise Lock with Magnetic Latch	130
SELECT Leversets & Knobsets	132
Mix Match Thumbturn Privacy Bolts	138
Studio Brass Leversets & Knobsets	140
Leversets & Knobsets	142

BARN DOOR HARDWARE

Privacy Locks	171
Low Profile Concealed Wheel Hangers	172
Flat Track Sliding	174

DOOR PULLS

24", 36", 48" and 72" Long Door Pulls	180
European Mortise Deadbolt with Integrated Roller Latch	182
Appliance Pulls, Door Pulls, Glass Shower Door Back-to-Back	183

POCKET DOOR LOCKS

Pocket Door Mortise Locks	194
Pocket Door Tubular Locks & Pocket Door Locks	198

DOOR ACCESSORIES

Flush Pulls	200
Heavy Duty Roller Latch	204
SELECT Hooks	211
Bath Hooks	212
House Numbers	215
Door Bells	216

HINGES

Square Barrel Solid Brass Hinges	219
Solid Brass Hinges	220
Steel Hinges	226
Stainless Steel Hinges	229
Spring Hinges	232
Hinge Screws	233

PARTS & OPTIONS

Replacement Parts	234
Index by Collection	241
Product Index	248
Order Form	258
Lifetime Limited Warranty	259



Determining handing for door hardware is different than determining handing for carpentry (ordering and hanging doors). If you follow the standard carpentry rules for handing door hardware, instead of following the diagram below, there is a good chance you may end up with a lock that is handed incorrectly. Please refer to the diagram below and if you have any questions, call Customer Service at (800) 356-2741, Option 1.

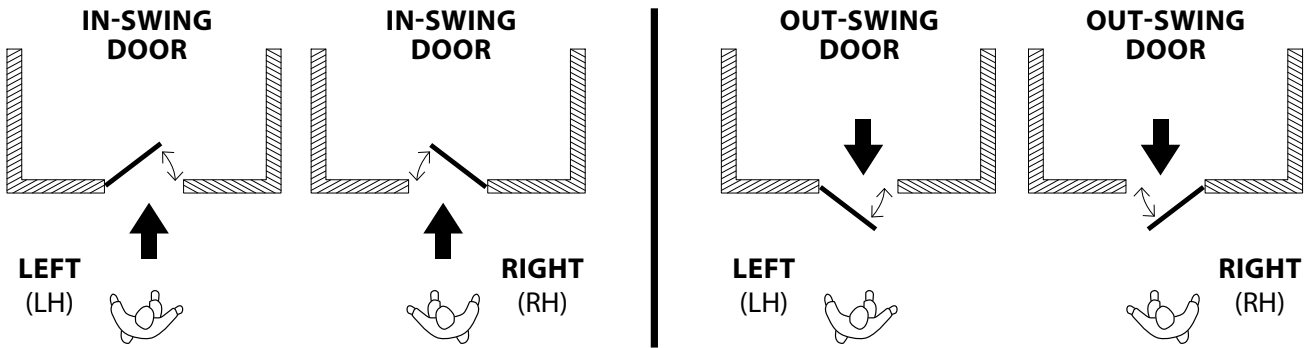

HANDING OF DOOR IS ALWAYS DETERMINED FROM THE OUTSIDE

- The outside of an exterior door is the street or entrance side.
- The outside of a room door is the hall side.
- The outside of a closet door is the room or hall side.
- The outside of a single communicating door is the side from which the hinges are not visible when the door is closed.

Key In Set Sample Views

Key In Knob



Key In Lever



Passage & Privacy Set Sample Views

Passage, Standard



Privacy, Standard

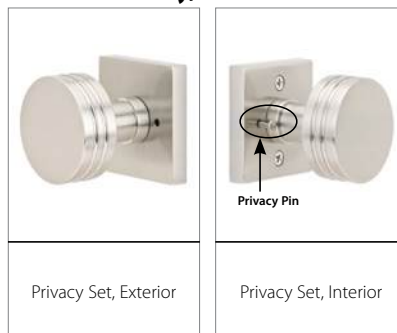

Passage, CF Mechanism



***Unlacquered Brass (US3NL)** is a custom, made-to-order finish. It is available with an upcharge, per item and requires an additional 2-3 day lead time. This living finish will gracefully age and evolve in appearance over time. Because of this characteristic, no finish warranty is offered on unlacquered brass products.



Polished Brass (US3)



Polished Brass - Lifetime (US3)



Unlacquered Brass (US3NL)*



Satin Brass (US4)



French Antique (US7)



Oil Rubbed Bronze (US10B)



Polished Nickel (US14)



Polished Nickel - Lifetime (US14)



Satin Nickel (US15)



Pewter (US15A)



Flat Black (US19)



Polished Chrome (US26)



Matte White (MW)



Satin Rose Gold (SRG)



Satin Copper (SCU)

Bronze Patina is a living finish that will age gracefully, revealing the underlying bronze over time. Because of this characteristic, no finish warranty is offered on bronze patina products.



Flat Black Bronze Patina (FB)



Medium Bronze Patina (MB)



Tumbled White Bronze (TWB)

Stainless Steel carries a five-year finish warranty. All stainless steel will require some periodic cleaning to keep your hardware looking like new.

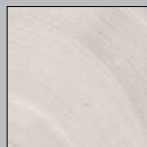

Brushed Stainless Steel (SS)



Polished Stainless Steel (PSS)

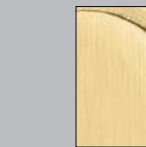

Satin Brass Stainless Steel - Lifetime (SSPVD4)

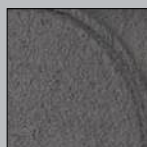

Flat Black Steel (FBS)

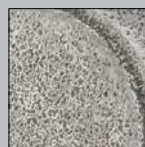

Satin Steel (SWS)

ORDERING AND RETURNS

Placing Orders

You have several options to place an order:

- Email: orders@emtek.com
- Phone: 800-356-2741
- Fax: 800-577-5771
- Online: <https://customerconnect.fbin.com/SignIn>

Hours of Operation

Monday – Friday: 5:00 AM - 5:00 PM Pacific Time.

Minimum Order Requirements

There are no minimum order quantity requirements.

Payment Terms

Net 30 Days on established credit.

Payment Options

We accept check, Visa, MasterCard, Discover, AMEX, and ACH.

Sales Tax

Sales tax charges apply unless a resale certificate is provided.

Prices

All prices listed are in US funds. Our prices are subject to change without prior notice.

Product Care

Clean products with a damp, non-abrasive cloth using mild dishwashing liquid and warm water. Wipe dry with a soft cloth; avoid harsh cleaners or waxes to preserve the finish and warranty. Prevent water or soap residue to maintain the protective coating.

Shipping Claims

All shipping claims must be submitted in writing within 30 days after the scheduled delivery for packages that have been lost or damaged. Please include the EMTEK order # and/or your PO#, package's tracking number along with photos for any damaged packages.

Returns

- For your convenience, returns within the United States do not require authorization. Returns can be processed directly from the Emtek Customer Portal <https://customerconnect.fbin.com/SignIn> or Emtek Dealer Site (<https://www.emtek.com/dealer-sign-in/>).
- All returns from outside of the United States will require pre-authorization. Please contact Emtek Customer Service at 800-356-2741, option 4 or email your request to rga@emtek.com.
- EMTEK Customer Portal: Once you are logged into your account, locate the original order under the Shipped section and select Request CCF/RGA. A link to generate a UPS call tag can be found on the Emtek Dealer Site. Terms and conditions apply – see the website for details.
- EMTEK Dealer Site: After logging in, select Returns. Fill out the RGA form and follow the link to generate a UPS call tag. Terms and conditions apply – see the website for details.
- Returns will only be accepted for products shipped within 180 days of invoice date.
- A completed RGA form must accompany all packages for returned goods.
- Returns are accepted from the EMTEK dealer who originally purchased the product that is being returned. Any refund or credit would only be made to the original dealer.
- All returned goods are subject to a minimum 25% restocking fee.
- Returns for reasons other than an EMTEK factory or processing error will be subject to our customary restocking fee with a return freight charge of \$20 per label/carton in the United States or \$35 per label/carton in Canada or Mexico. This charge will be deducted from the credit issued for each call tag.

SHIPPING AND FREIGHT

Shipping Costs

All orders are FOB shipping point. For shipments to a dealer-specified commercial address located in the US, Canada and Mexico, EMTEK ships freight prepaid. For shipments to dealers located outside of North America, freight will be prepaid by EMTEK and to the U.S. location of the dealer's freight forwarder. Orders may ship ground service or LTL at our discretion. Orders shipping to a residential address will automatically ship via ground service with a 10% surcharge.

Shipping Options

Shipments may be expedited for a fee. Unfortunately, a dealer's freight account cannot be used to pay for shipping charges.

Delivery Location	Type of Service	Surcharge %*
Commercial Address	Next Day	16%
Commercial Address	Second Day	6%
Residential Address	Next Day	25%
Residential Address	Second Day	20%
Residential Address	Three Day	15%
Residential Address	Ground (Default Service)	10%

*Multiplied by invoice value

Order Lead Time

EMTEK assembles all products to order in our Southern California facility. Orders typically ship within two to three business days once an order is released to the factory.

DEALER INFORMATION PORTAL

Online Account Access and Ordering

We are pleased to offer you access to your EMTEK account information, place new orders, and initiate Product Returns (RGA) through the EMTEK Customer Portal. Through the customer portal, you can access information about your account at any time. You can:

- Check on the status of orders
- View both order and sales history
- View and print order acknowledgments, invoices, statements, and credits
- Track shipments
- Initiate Product Return/RGA
- Pay invoices via credit card

To register for the EMTEK Customer Portal, please complete our registration form at customerconnect.fbin.com/registration/. If your business already has an Administrative user, please coordinate with them for access. Should you have any questions, feel free to contact Customer Service.

NO CHARGE SAMPLE PROGRAM

Samples are gladly provided at no charge to authorized dealers under the following conditions:

- ½ Door Lock Dummy (max 2)
- ½ Pair of Hinges (max 2)
- Cabinet Knob or Pull (max 3)
- Door Accessory (max 1)

A shipping and handling fee of \$2.50 per sample will be applied to your order (\$2.50 for one sample, \$5.00 for two samples, \$7.50 for three samples, etc.)

Sample Order Exceptions

- Samples must be different product codes.
- Samples do not include active door hardware sets, 8" or larger cabinet pulls, door pulls, appliance pulls, electronic locks, entry sets, bath hardware or door accessories over \$75 list price.

Placing a Sample Order

- Send orders to samples@emtek.com or place by fax, phone or mail.
- Write "NO CHARGE SAMPLE" on the order.
- Standard shipment upgrade charges will apply for expedited freight requests.
- Orders for sample products must be placed separately and not combined with other products.
- EMTEK does not require samples to be returned.

No Restocking Fee Charged for Sample Orders with Exceptions

- Send orders to samples@emtek.com or place by fax, phone or mail.
- Write "DEALER SAMPLE" on the order.
- Keep the samples you want and return the samples you don't.
- Contact Customer Service for Return Authorization in advance to ensure a restock fee is not applied to the return.
- Product must be returned in its original condition.
- Return freight charge of \$20 per label/carton in the United States or \$35 per label/carton in Canada or Mexico. This charge will be deducted from the credit issued for each call tag.
- No freight will be charged if the return is sent prepaid.

DISPLAY PROGRAM

EMTEK offers a variety of quality, well-crafted displays. We take great pride in the quality of our displays, which are hand-built in our Southern California facility by our talented craftsmen.

Log into the "Dealer Sign In" (<https://www.emtek.com/dealer-sign-in/>) and then select "Product Displays".

Placing a Display Order

Please contact your local sales representative for ordering information.

Product for use on Displays in your Showroom

Thank you for considering EMTEK products for use on door displays and kitchen/bath vignettes installed in your showroom. Please contact your local sales representative for ordering information.

MINIMUM ADVERTISED PRICE POLICY

Effective February 6, 2017

EMTEK has determined that in order to better compete against existing competitors it must exercise a greater degree of control over the distribution of its products. Therefore, all sales of EMTEK products will be subject to this Policy. This Policy has been unilaterally adopted and will be enforced strictly and uniformly.

Although resellers remain free to establish their own resale prices, to the extent that any customer elects to advertise products of EMTEK in any manner, that is in print, in electronic media, on its website, etc., and provides price information for such products, that price information must be no less than List Price less 20%, this is the Minimum Advertised Price (MAP). Advertisements and offers to sell that do not include a particular price, but require further action that implies a price that is lower than the Minimum Advertised Price violate the MAP Policy. Examples of such unauthorized advertisements include "drop in cart" pricing, "add to cart" pricing, "click to see" pricing, and discount coupon pricing. Also prohibited are advertisements that indicate that discounts may be available when a customer takes specific action that goes beyond buying the product, such as "special price option" or "name your price."

To assure fair business practices, we will strictly enforce this policy. Violations of this MAP Policy will include termination of our business relationship with a customer. On the first offense there will be a written notice counseling any customer that disregards this policy. Any customer who violates the policy a second time, within one year of receiving a written notice of a first violation, will be terminated.

EMTEK will not discuss any conditions of acceptance related to this Policy, as it is non-negotiable and will not be altered for any dealer. In addition, EMTEK neither solicits, nor will it accept, any assurance of compliance with this Policy. Nothing in this Policy shall constitute an agreement between EMTEK and any reseller that the reseller will comply with this Policy. For more information, please email to: mapp.emtek@emtek.com

SELECT BRASS LEVERS

					
L-Square Faceted (LS.FA)	L-Square Hammered (LS.HA)	L-Square Knurled (LS.KN)	L-Square Straight Knurled (LS.SK)	L-Square Tribeca (LS.TR)	L-Square Smooth (LS.SM)
					
L-Square Green Marble (LS.MRGN)	L-Square Rosso Levanto (LS.MRRD)	L-Square White Marble (LS.MRWH)	L-Square Light Terrazzo (LS.TZLT)	L-Square Dark Walnut (LS.WNWD)	
					
T-Bar Faceted (TA.FA)	T-Bar Hammered (TA.HA)	T-Bar Knurled (TA.KN)	T-Bar Straight Knurled (TA.SK)	T-Bar Tribeca (TA.TR)	T-Bar Smooth (TA.SM)
					
T-Bar Green Marble (TA.MRGN)	T-Bar Rosso Levanto (TA.MRRD)	T-Bar White Marble (TA.MRWH)	T-Bar Light Terrazzo (TA.TZLT)	T-Bar Dark Walnut (TA.WNWD)	
					
R-Bar Faceted (RA.FA)	R-Bar Hammered (RA.HA)	R-Bar Knurled (RA.KN)	R-Bar Straight Knurled (RA.SK)	R-Bar Tribeca (RA.TR)	R-Bar Smooth (RA.SM)
					
R-Bar Green Marble (RA.MRGN)	R-Bar Rosso Levanto (RA.MRRD)	R-Bar White Marble (RA.MRWH)	R-Bar Light Terrazzo (RA.TZLT)	R-Bar Dark Walnut (RA.WNWD)	

MODERN BRASS ROSETTES

					
Disk Rosette	Modern Rectangular Rosette	Quincy Rosette	Square Rosette	Urban Modern Rosette	Wilshire Rosette

MODERN BRASS SIDEPLATES

				
1 1/2" x 3" STRETTO Oval	1 1/2" x 5" STRETTO	2" x 10" STRETTO Modern Rectangular	1 1/2" x 11" STRETTO Modern Rectangular	2 7/16" x 7" Modern Sideplate

	US4	US7	US10B	US14 Lifetime	US15	US15A	US19	US26	US3NL	MW	SRG
SELECT Brass Levers	L-Square Faceted (LS.FA)	•	•	•	•		•	•	•		
	L-Square Hammered (LS.HA)	•	•	•	•		•	•	•		
	L-Square Knurled (LS.KN)	•	•	•	•	•	•	•	•	•	•
	L-Square Straight Knurled (LS.SK)	•	•	•	•	•	•	•	•	•	•
	L-Square Tribeca (LS.TR)	•	•	•	•		•	•	•		
	L-Square Smooth (LS.SM)	•	•	•	•	•	•	•	•	•	•
	L-Square Green Marble (LS.MRGN)	•	•	•	•	•	•	•	•	•	•
	L-Square Rosso Levanto (LS.MRRD)	•	•	•	•	•	•	•	•	•	•
	L-Square White Marble (LS.MRWH)	•	•	•	•	•	•	•	•	•	•
	L-Square Light Terrazzo (LS.TZLT)	•	•	•	•	•	•	•	•	•	•
	L-Square Dark Walnut (LS.WNWD)	•	•	•	•	•	•	•	•	•	•
	T-Bar Faceted (TA.FA)	•	•	•	•			•	•	•	
	T-Bar Hammered (TA.HA)	•	•	•	•			•	•	•	
	T-Bar Knurled (TA.KN)	•	•	•	•	•	•	•	•	•	•
	T-Bar Straight Knurled (TA.SK)	•	•	•	•	•	•	•	•	•	•
	T-Bar Tribeca (TA.TR)	•	•	•	•			•	•	•	
	T-Bar Smooth (TA.SM)	•	•	•	•	•	•	•	•	•	•
	T-Bar Green Marble (TA.MRGN)	•	•	•	•	•	•	•	•	•	•
	T-Bar Rosso Levanto (TA.MRRD)	•	•	•	•	•	•	•	•	•	•
	T-Bar White Marble (TA.MRWH)	•	•	•	•	•	•	•	•	•	•
	T-Bar Light Terrazzo (TA.TZLT)	•	•	•	•	•	•	•	•	•	•
	T-Bar Dark Walnut (TA.WNWD)	•	•	•	•	•	•	•	•	•	•
R-Bar Faceted (RA.FA)	•	•	•	•	•		•	•	•		
R-Bar Hammered (RA.HA)	•	•	•	•	•		•	•	•		
R-Bar Knurled (RA.KN)	•	•	•	•	•	•	•	•	•	•	
R-Bar Straight Knurled (RA.SK)	•	•	•	•	•	•	•	•	•	•	
R-Bar Tribeca (RA.TR)	•	•	•	•	•		•	•	•		
R-Bar Smooth (RA.SM)	•	•	•	•	•	•	•	•	•	•	
R-Bar Green Marble (RA.MRGN)	•	•	•	•	•	•	•	•	•	•	
R-Bar Rosso Levanto (RA.MRRD)	•	•	•	•	•	•	•	•	•	•	
R-Bar White Marble (RA.MRWH)	•	•	•	•	•	•	•	•	•	•	
R-Bar Light Terrazzo (RA.TZLT)	•	•	•	•	•	•	•	•	•	•	
R-Bar Dark Walnut (RA.WNWD)	•	•	•	•	•	•	•	•	•	•	
Modern Brass Rosettes	Disk Rosette	•	•	•	•	•	•	•	•	•	•
	Modern Rectangular Rosette	•	•	•	•		•	•	•		
	Quincy Rosette	•	•	•	•	•	•	•	•	•	•
	Square Rosette	•	•	•	•	•	•	•	•	•	•
	Urban Modern Rosette	•	•	•	•	•	•	•	•	•	•
	Wilshire Rosette	•	•	•	•	•	•	•	•	•	
Modern Brass Sideplates	1½" x 3" STRETTO Oval	•		•	•		•	•	•		
	1½" x 5" STRETTO	•		•	•		•	•	•		
	2" x 10" STRETTO Modern Rectangular	•		•	•		•	•	•		
	1½" x 11" STRETTO Modern Rectangular	•		•	•		•	•	•		
	2⅞" x 7" Modern Sideplate	•		•	•		•	•	•		

SELECT BRASS KNOBS



Conical Knurled
(CC.KNK)



Conical Straight Knurled
(CC.SKK)



Conical Green Marble
(CC.MRKGN)



Conical Rosso Levanto
(CC.MRKRD)



Conical White Marble
(CC.MRKWH)



Conical Light Terrazzo
(CC.TZKLT)



Conical Dark Walnut
(CC.WNKWD)

MODERN BRASS ROSETTES



Disk
Rosette



Modern Rectangular
Rosette



Quincy
Rosette



Square
Rosette



Urban Modern
Rosette



Wilshire
Rosette

MODERN BRASS SIDEPLATES



1 1/2" x 3"
STRETTO
Oval



1 1/2" x 5"
STRETTO



2" x 10"
STRETTO
Modern
Rectangular



1 1/2" x 11"
STRETTO
Modern
Rectangular



2 7/16" x 7"
Modern
Sideplate

		US4	US7	US10B	US14 Lifetime	US15	US19	US26	US3NL
SELECT Brass Knobs	Conical Knurled (CC.KNK)	•	•	•	•	•	•	•	•
	Conical Straight Knurled (CC.SKK)	•	•	•	•	•	•	•	•
	Conical Green Marble (CC.MRKGN)	•	•	•	•	•	•	•	•
	Conical Rosso Levanto (CC.MRKRD)	•	•	•	•	•	•	•	•
	Conical Light Terrazzo (CC.TZKLT)	•	•	•	•	•	•	•	•
	Conical White Marble (CC.MRKWH)	•	•	•	•	•	•	•	•
	Conical Dark Walnut (CC.WNKWD)	•	•	•	•	•	•	•	•
Modern Brass Rosettes	Disk Rosette	•	•	•	•	•	•	•	•
	Modern Rectangular Rosette	•	•	•	•	•	•	•	•
	Quincy Rosette	•	•	•	•	•	•	•	•
	Square Rosette	•	•	•	•	•	•	•	•
	Urban Modern Rosette	•	•	•	•	•	•	•	•
	Wilshire Rosette	•	•	•	•	•	•	•	•
Modern Brass Sideplates	1½" x 3" STRETTO Oval	•		•	•	•	•	•	•
	1½" x 5" STRETTO	•		•	•	•	•	•	•
	2" x 10" STRETTO Modern Rectangular	•		•	•	•	•	•	•
	1½" x 11" STRETTO Modern Rectangular	•		•	•	•	•	•	•
	2¾" x 7" Modern Sideplate	•		•	•	•	•	•	•

STUDIO BRASS KNOBS



The Ace Knob
(ACE)



The Ace Knurled Knob
(ACEKN)



Spoke Knob
(SPK)

MODERN BRASS LEVERS

CLASSIC



Athena Lever
(ATN)



Helios Lever
(HLO)



Hermes Lever
(HER)



Luzern Lever
(LU)



Poseidon Lever
(POS)



Stuttgart Lever
(STU)

DESIGNER



Argos Lever
(AG)



Aston Lever
(AST)



Basel Lever
(BA)



Breslin Lever
(BRL)



Dumont Lever
(DT)



Freestone Lever
(FRL)



Geneva Lever
(GV)



Hercules Lever
(HEC)



Mercury Lever
(MC)



Myles Lever
(MYL)



Sion Lever
(SIO)



Spencer Lever
(SPN)



Triton Lever
(TRT)

MODERN BRASS ROSETTES



Disk
Rosette



Modern Rectangular
Rosette



Modern
Rosette



Neos
Rosette



Quincy
Rosette



Square
Rosette



Urban Modern
Rosette



Wilshire
Rosette

MODERN BRASS SIDEPLATES



1 1/2" x 3"
STRETTO
Oval



1 1/2" x 5"
STRETTO



2" x 10"
STRETTO
Modern
Rectangular



1 1/2" x 11"
STRETTO
Modern
Rectangular



2 7/16" x 7"
Modern
Sideplate

	US4	US7	US10B	US14 Lifetime	US15	US15A	US19	US26	US3NL	MW	SRG
STUDIO Brass Knobs	The Ace Knob (ACE)	•	•	•	•	•	•	•	•	•	•
	The Ace Knurled Knob (ACEKN)	•	•	•	•	•	•	•	•	•	•
	Spoke Knob (SPK)	•	•	•	•	•	•	•	•	•	•
Modern Classic Brass Levers	Athena Lever (ATN)	•	•	•	•		•	•	•		
	Helios Lever (HLO)	•	•	•	•		•	•	•		
	Hermes Lever (HER)	•	•	•	•		•	•	•		
	Luzern Lever (LU)	•	•	•	•		•	•	•		
	Poseidon Lever (POS)	•	•	•	•		•	•	•		
	Stuttgart Lever (STU)	•	•	•	•		•	•	•		
	Argos Lever (AG)	•	•	•	•	•		•	•	•	
	Aston Lever (AST)	•	•	•	•	•		•	•	•	
Modern Designer Brass Levers	Basel Lever (BA)	•	•	•	•		•	•	•		
	Breslin Lever (BRL)	•	•	•	•		•	•	•		
	Dumont Lever (DT)	•	•	•	•		•	•	•		
	Freestone Lever (FRL)	•	•	•	•		•	•	•		
	Geneva Lever (GV)	•	•	•	•		•	•	•		
	Hercules Lever (HEC)	•	•	•	•		•	•	•		
	Mercury Lever (MC)	•	•	•	•		•	•	•		
	Myles Lever (MYL)	•	•	•	•		•	•	•		
	Sion Lever (SIO)	•	•	•	•		•	•	•		
	Spencer Lever (SPN)	•	•	•	•		•	•	•		
Modern Brass Rosettes	Triton Lever (TRT)	•	•	•	•		•	•	•		
	Disk Rosette	•	•	•	•	•	•	•	•	•	•
	Modern Rectangular Rosette	•	•	•	•		•	•	•		
	Modern Rosette	•	•	•	•		•	•	•		
	Neos Rosette	•	•	•	•		•	•	•		
	Quincy Rosette	•	•	•	•	•	•	•	•	•	•
	Square Rosette	•	•	•	•	•	•	•	•	•	•
	Urban Modern Rosette	•	•	•	•	•	•	•	•	•	•
	Wilshire Rosette	•	•	•	•	•	•	•	•		
	Modern Brass Sideplates	1½" x 3" STRETTO Oval	•		•	•		•	•	•	
1½" x 5" STRETTO		•		•	•		•	•	•		
2" x 10" STRETTO Modern Rectangular		•		•	•		•	•	•		
1½" x 11" STRETTO Modern Rectangular		•		•	•		•	•	•		
2⅞" x 7" Modern Sideplate		•		•	•		•	•	•		

MODERN BRASS KNOBS

CLASSIC						
	Orb Knob (OR)	Round Knob (ROU)				
DESIGNER						
	Bern Knob (BN)	Freestone Knob (FRK)	Hammered Egg Knob (HE)	Laurent Knob (LAU)	Octagon Knob (OCT)	Square Knob (SQU)
	Verve Knob (VR)					

MODERN GLASS KNOBS

Bristol Glass Knob (BL)	Hampton Glass Knob (HT)	Modern Disc Glass Knob (MDC)	Modern Square Glass Knob (MSC)	Windsor Glass Knob (WS)

MODERN BRASS ROSETTES

Disk Rosette	Modern Rectangular Rosette	Modern Rosette	Neos Rosette	Quincy Rosette	Square Rosette
Urban Modern Rosette	Wilshire Rosette				

MODERN BRASS SIDEPLATES

1 1/2" x 3" STRETTO Oval	1 1/2" x 5" STRETTO	2" x 10" STRETTO Modern Rectangular	1 1/2" x 11" STRETTO Modern Rectangular	2 1/6" x 7" Modern Sideplate

	US4	US7	US10B	US14 Lifetime	US15	US19	US26	US3NL
Modern Classic Brass Knobs								
Orb Knob (OR)	•	•	•	•	•	•	•	•
Round Knob (ROU)	•	•	•	•	•	•	•	•
Modern Designer Brass Knobs								
Bern Knob (BN)	•	•	•	•	•	•	•	•
Freestone Knob (FRK)	•	•	•	•	•	•	•	•
Hammered Egg Knob (HE)	•	•	•	•	•	•	•	•
Laurent Knob (LAU)	•	•	•	•	•	•	•	•
Octagon Knob (OCT)	•	•	•	•	•	•	•	•
Square Knob (SQU)	•	•	•	•	•	•	•	•
Verve Knob (VR)	•	•	•	•	•	•	•	•
Modern Glass Knobs								
Bristol Glass Knob (BL)	•	•	•	•	•	•	•	•
Hampton Glass Knob (HT)	•	•	•	•	•	•	•	•
Modern Disc Glass Knob (MDC)	•	•	•	•	•	•	•	•
Modern Square Glass Knob (MSC)	•	•	•	•	•	•	•	•
Windsor Glass Knob (WS)	•	•	•	•	•	•	•	•
Modern Brass Rosettes								
Disk Rosette	•	•	•	•	•	•	•	•
Modern Rectangular Rosette	•	•	•	•	•	•	•	•
Modern Rosette	•	•	•	•	•	•	•	•
Neos Rosette	•	•	•	•	•	•	•	•
Quincy Rosette	•	•	•	•	•	•	•	•
Square Rosette	•	•	•	•	•	•	•	•
Urban Modern Rosette	•	•	•	•	•	•	•	•
Wilshire Rosette	•	•	•	•	•	•	•	•
Modern Brass Sideplates								
1½" x 3" STRETTO Oval	•		•	•	•	•	•	•
1½" x 5" STRETTO	•		•	•	•	•	•	•
2" x 10" STRETTO Modern Rectangular	•		•	•	•	•	•	•
1½" x 11" STRETTO Modern Rectangular	•		•	•	•	•	•	•
2⅞" x 7" Modern Sideplate	•		•	•	•	•	•	•

TRADITIONAL AND TRANSITIONAL BRASS LEVERS & KNOBS

CLASSIC						
	Cortina Lever (C)	Manning Lever (MNG)	Merrimack Lever (ME)	Milano Lever (M)	Turino Lever (T)	
DESIGNER						
	Coventry Lever (CV)	Elan Lever (EN)	Ribbon & Reed Lever (RBL)	Rope Lever (RL)	Rustic Lever (R)	Santa Fe Lever (SF)
	Wembley Lever (WM)					
CLASSIC						
	Egg Knob (E)	Melon Knob (MN)	Norwich Knob (NW)	Providence Knob (P)	Waverly Knob (W)	
DESIGNER						
	Belmont Knob (BT)	Lancaster Knob (LN)	Ribbon & Reed Knob (RBK)	Rope Knob (RK)	Victoria Knob (V)	

TRADITIONAL AND TRANSITIONAL BRASS ROSETTES

CLASSIC							
	#8 Rosette	Oval Rosette	Rectangular Rosette	Regular Rosette	Quincy Rosette	Watford Rosette	Wilshire Rosette
DESIGNER							
	Lancaster Rosette	Ribbon & Reed Rosette	Rope Rosette				

TRADITIONAL AND TRANSITIONAL BRASS SIDEPLATES

Belmont Sideplate	Colonial Sideplate	Delaware Sideplate	Quincy Sideplate	Rope Sideplate	Victoria Sideplate	Wilshire Sideplate

		US3 Lifetime	US4	US7	US10B	US14 Lifetime	US15	US15A	US19	US26	US3NL
Classic Brass Levers	Cortina Lever (C)	•	•	•	•	•	•	•	•	•	•
	Manning Lever (MNG)	•	•	•	•	•	•	•	•	•	•
	Merrimack Lever (ME)	•	•	•	•	•	•	•	•	•	•
	Milano Lever (M)	•	•	•	•	•	•	•	•	•	•
	Turino Lever (T)	•	•	•	•	•	•	•	•	•	•
Designer Brass Levers	Coventry Lever (CV)	•		•	•		•	•		•	•
	Elan Lever (EN)	•		•	•		•	•		•	•
	Ribbon & Reed Lever (RBL)	•		•	•		•	•		•	•
	Rope Lever (RL)	•		•	•		•	•		•	•
	Rustic Lever (R)	•		•	•		•	•		•	•
	Santa Fe Lever (SF)	•		•	•		•	•		•	•
Classic Brass Knobs	Wembley Lever (WM)	•		•	•		•	•		•	•
	Egg Knob (E)	•	•	•	•	•	•	•	•	•	•
	Melon Knob (MN)	•	•	•	•	•	•	•	•	•	•
	Norwich Knob (NW)	•	•	•	•	•	•	•	•	•	•
	Providence Knob (P)	•	•	•	•	•	•	•	•	•	•
Designer Brass Knobs	Waverly Knob (W)	•	•	•	•	•	•	•	•	•	•
	Belmont Knob (BT)	•		•	•		•	•		•	•
	Lancaster Knob (LN)	•		•	•		•	•		•	•
	Ribbon & Reed Knob (RBK)	•		•	•		•	•		•	•
	Rope Knob (RK)	•		•	•		•	•		•	•
Classic Brass Rosettes	Victoria Knob (V)	•		•	•		•	•		•	•
	#8 Rosette	•	•	•	•	•	•	•	•	•	•
	Oval Rosette	•	•	•	•	•	•	•	•	•	•
	Rectangular Rosette	•	•	•	•	•	•	•	•	•	•
	Regular Rosette	•	•	•	•	•	•	•	•	•	•
	Quincy Rosette	•	•	•	•	•	•	•	•	•	•
	Watford Rosette	•	•	•	•	•	•	•	•	•	•
	Wilshire Rosette	•	•	•	•	•	•	•	•	•	•
Designer Brass Rosettes	Lancaster Rosette	•		•	•		•	•		•	•
	Ribbon & Reed Rosette	•		•	•		•	•		•	•
	Rope Rosette	•		•	•		•	•		•	•
Brass Sideplates	Belmont Sideplate	•		•	•		•				•
	Colonial Sideplate	•		•	•	•	•	•	•	•	•
	Delaware Sideplate	•		•	•	•	•	•	•	•	•
	Quincy Sideplate	•		•	•	•	•	•	•	•	•
	Rope Sideplate	•		•	•		•				•
	Victoria Sideplate	•		•	•		•				•
	Wilshire Sideplate	•	•	•	•	•	•	•	•	•	•

PORCELAIN



Ebony Knob
(EB)



Ice White Knob
(IW)



Porcelain
Rosette

ARTS & CRAFTS



Arts & Crafts Lever
(AC)



Hammered Lever
(HM)



Hammered Egg Knob
(HE)



Arts & Crafts
Rectangular Rosette



Hammered
Rosette

TRADITIONAL AND TRANSITIONAL BRASS ROSETTES

CLASSIC



#8
Rosette



Oval
Rosette



Rectangular
Rosette



Regular
Rosette



Quincy
Rosette



Watford
Rosette



Wilshire
Rosette

DESIGNER



Lancaster
Rosette



Ribbon & Reed
Rosette



Rope
Rosette

TRADITIONAL AND TRANSITIONAL BRASS SIDEPLATES



Belmont
Sideplate



Colonial
Sideplate



Delaware
Sideplate



Quincy
Sideplate



Rope
Sideplate



Victoria
Sideplate



Wilshire
Sideplate

		US3 Lifetime	US4	US7	US10B	US14 Lifetime	US15	US15A	US19	US26	US3NL
Porcelain Knobs & Rosette	Ebony Porcelain Knob (EB)	•	•	•	•	•	•	•	•	•	•
	Ice White Porcelain Knob (IW)	•	•	•	•	•	•	•	•	•	•
	Porcelain Rosette	•		•	•		•	•	•	•	
Arts & Crafts Levers, Knob & Rosettes	Arts & Crafts Lever (AC)				•		•		•		•
	Hammered Lever (HM)				•		•		•		•
	Hammered Egg Knob (HE)		•	•	•	•	•		•	•	•
	Arts & Crafts Rectangular Rosette				•		•		•		•
	Hammered Rosette				•		•		•		•
Classic Brass Rosettes	#8 Rosette	•	•	•	•	•	•	•	•	•	•
	Oval Rosette	•	•	•	•	•	•	•	•	•	•
	Rectangular Rosette	•	•	•	•	•	•	•	•	•	•
	Regular Rosette	•	•	•	•	•	•	•	•	•	•
	Quincy Rosette	•	•	•	•	•	•	•	•	•	•
	Watford Rosette	•	•	•	•	•	•	•	•	•	•
	Wilshire Rosette	•	•	•	•	•	•	•	•	•	•
Designer Brass Rosettes	Lancaster Rosette	•		•	•		•	•		•	•
	Ribbon & Reed Rosette	•		•	•		•	•		•	•
	Rope Rosette	•		•	•		•	•		•	•
Brass Sideplates	Belmont Sideplate	•		•	•		•				•
	Colonial Sideplate	•		•	•	•	•	•	•	•	•
	Delaware Sideplate	•		•	•	•	•	•	•	•	•
	Quincy Sideplate	•		•	•	•	•	•	•	•	•
	Rope Sideplate	•		•	•		•				•
	Victoria Sideplate	•		•	•		•				•
	Wilshire Sideplate	•	•	•	•	•	•	•	•	•	•

GLASS KNOBS



Astoria Glass Knob
(AS)



Bristol Glass Knob
(BL)



Diamond Glass Knob
(CK)



Georgetown Glass Knob
(GT)



Hampton Glass Knob
(HT)



Lowell Glass Knob
(LW)



Modern Disc Glass Knob
(MDC)



Modern Square Glass Knob
(MSC)



Old Town Glass Knob
(OT)



Providence Glass Knob
(PC)



Windsor Glass Knob
(WS)

TRADITIONAL AND TRANSITIONAL BRASS ROSETTES



#8
Rosette



Oval
Rosette



Rectangular
Rosette



Regular
Rosette



Quincy
Rosette



Watford
Rosette



Wilshire
Rosette



Lancaster
Rosette



Ribbon & Reed
Rosette



Rope
Rosette

MODERN BRASS ROSETTES



Disk
Rosette



Modern Rectangular
Rosette



Modern
Rosette



Neos
Rosette



Square
Rosette



Urban Modern
Rosette

SANDCAST BRONZE ROSETTES



#1
Rosette



#2
Rosette



#3
Rosette



#4
Rosette



#6
Rosette

		US3 Lifetime	US4	US7	US10B	US14 Lifetime	US15	US15A	US19	US26	US3NL	FB	MB	TWB
Glass Knobs	Astoria Glass Knob (AS)	•	•	•	•	•	•	•	•	•	•	•	•	•
	Bristol Glass Knob (BL)	•	•	•	•	•	•	•	•	•	•	•	•	•
	Diamond Glass Knob (CK)	•	•	•	•	•	•	•	•	•	•	•	•	•
	Georgetown Glass Knob (GT)	•	•	•	•	•	•	•	•	•	•	•	•	•
	Hampton Glass Knob (HT)	•	•	•	•	•	•	•	•	•	•	•	•	•
	Lowell Glass Knob (LW)	•	•	•	•	•	•	•	•	•	•	•	•	•
	Modern Disc Glass Knob (MDC)	•	•	•	•	•	•	•	•	•	•	•	•	•
	Modern Square Glass Knob (MSC)	•	•	•	•	•	•	•	•	•	•	•	•	•
	Old Town Glass Knob (OT)	•	•	•	•	•	•	•	•	•	•	•	•	•
	Providence Glass Knob (PC)	•	•	•	•	•	•	•	•	•	•	•	•	•
	Windsor Glass Knob (WS)	•	•	•	•	•	•	•	•	•	•	•	•	•
Classic Brass Rosettes	#8 Rosette	•	•	•	•	•	•	•	•	•	•			
	Oval Rosette	•	•	•	•	•	•	•	•	•	•			
	Rectangular Rosette	•	•	•	•	•	•	•	•	•	•			
	Regular Rosette	•	•	•	•	•	•	•	•	•	•			
	Quincy Rosette	•	•	•	•	•	•	•	•	•	•			
	Watford Rosette	•	•	•	•	•	•	•	•	•	•			
	Wilshire Rosette	•	•	•	•	•	•	•	•	•	•			
Designer Brass Rosettes	Lancaster Rosette	•		•	•		•	•		•	•			
	Ribbon & Reed Rosette	•		•	•		•	•		•	•			
	Rope Rosette	•		•	•		•	•		•	•			
Modern Brass Rosettes	Disk Rosette		•	•	•	•	•	•	•	•	•			
	Modern Rectangular Rosette		•	•	•	•	•		•	•	•			
	Modern Rosette		•	•	•	•	•		•	•	•			
	Neos Rosette		•	•	•	•	•		•	•	•			
	Square Rosette		•	•	•	•	•	•	•	•	•			
	Urban Modern Rosette		•	•	•	•	•	•	•	•	•			
Sandcast Bronze Rosettes	#1 Rosette											•	•	•
	#2 Rosette											•	•	•
	#3 Rosette											•	•	•
	#4 Rosette											•	•	•
	#6 Rosette											•	•	•

SANDCAST BRONZE LEVERS, KNOBS & ROSETTES



Aurora Lever
(AR)



Bryce Lever
(BR)



Cimarron Lever
(CR)



Cody Lever
(CD)



Durango Lever
(D)



Lariat Lever
(LR)



Mariposa Lever
(MA)



Montrose Lever
(MT)



Teton Lever
(TT)



Yuma Lever
(YM)



Butte Knob
(BU)



Egg Knob
(BZEG)



Round Knob
(BZRN)



Winchester Knob
(WC)



#1
Rosette



#2
Rosette



#3
Rosette



#4
Rosette



#6
Rosette

TUSCANY BRONZE LEVERS, KNOBS & ROSETTES



Medici Lever
(MDI)



Napoli Lever
(NA)



Octagon Lever
(OCL)



Padua Lever
(PD)



Octagon Knob
(OCK)



Parma Knob
(PA)



Petal Knob
(PT)



#11
Rosette



#12
Rosette



#14
Rosette



#15
Rosette

		FB	MB	TWB
Sandcast Bronze Levers	Aurora Lever (AR)	•	•	•
	Bryce Lever (BR)	•	•	•
	Cimarron Lever (CR)	•	•	•
	Cody Lever (CD)	•	•	•
	Durango Lever (D)	•	•	•
	Lariat Lever (LR)	•	•	•
	Mariposa Lever (MA)	•	•	•
	Montrose Lever (MT)	•	•	•
	Teton Lever (TT)	•	•	•
	Yuma Lever (YM)	•	•	•
Sandcast Bronze Knobs	Butte Knob (BU)	•	•	•
	Egg Knob (BZEG)	•	•	•
	Round Knob (BZRN)	•	•	•
	Winchester Knob (WC)	•	•	•
Sandcast Bronze Rosettes	#1 Rosette	•	•	•
	#2 Rosette	•	•	•
	#3 Rosette	•	•	•
	#4 Rosette	•	•	•
	#6 Rosette	•	•	•
			FB	MB
Tuscany Bronze Levers	Medici Lever (MDI)		•	•
	Napoli Lever (NA)		•	•
	Octagon Lever (OCL)		•	•
	Padua Lever (PD)		•	•
Tuscany Bronze Knobs	Octagon Knob (OCK)		•	•
	Parma Knob (PA)		•	•
	Petal Knob (PT)		•	•
Tuscany Bronze Rosettes	#11 Rosette		•	•
	#12 Rosette		•	•
	#14 Rosette		•	•
	#15 Rosette		•	•

WROUGHT STEEL LEVERS, KNOBS & ROSETTES



Lafayette Lever
(L)



Normandy Lever
(N)



San Carlos Lever
(SC)

Porcelain Knobs with Wrought Steel Stems



Jamestown Knob
(J)



Savannah Knob
(SV)



Madison Black Knob
(MB)



Madison Ivory Knob
(MI)



#1
Rosette



#2
Rosette



#3
Rosette

STAINLESS STEEL LEVERS, KNOBS & ROSETTES



Athena Lever
(AT)



Cologne Lever
(CO)



Dresden Lever
(DD)



Helios Lever
(HL)



Hercules Lever
(HS)



Hermes Lever
(HES)



Kiel Lever
(KL)



Poseidon Lever
(PO)



Stuttgart Lever
(STT)



Octagon Knob
(OK)



Round Knob
(RNK)



Disk (02)
Rosette



Square (03)
Rosette

		FBS	SWS
Wrought Steel Levers	Lafayette Lever (L)	•	•
	Normandy Lever (N)	•	•
	San Carlos Lever (SC)	•	•
Wrought Steel Knobs	Jamestown Knob (J)	•	•
	Savannah Knob (SV)	•	•
	Madison Black Knob (MB)	•	•
	Madison Ivory Knob (MI)	•	•
Wrought Steel Rosettes	#1 Rosette	•	•
	#2 Rosette	•	•
	#3 Rosette	•	•
			SS
Stainless Steel Levers	Athena Lever (AT)		•
	Cologne Lever (CO)		•
	Dresden Lever (DD)		•
	Helios Lever (HL)		•
	Hercules Lever (HS)		•
	Hermes Lever (HES)		•
	Kiel Lever (KL)		•
	Poseidon Lever (PO)		•
	Stuttgart Lever (STT)		•
Stainless Steel Knobs	Octagon Knob (OK)		•
	Round Knob (RNK)		•
Stainless Steel Rosettes	Disk (02) Rosette		•
	Square (03) Rosette		•

EMPOWERED™ 2

Ultimate smart convenience — at your fingertips.

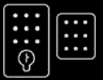

Keyed + Key-Free
Options



Biometric
Fingerprint
Access



Works with the
Yale Access App*

Works with the Yale Access App*

The easy-to-use Yale Access App offers trusted everyday convenience and security for your entire home.

- Share permanent, scheduled or temporary access with the people you trust.
- Manage all of your Emtek, Yale, or August Wi-Fi and Bluetooth products from one app location.

Features available with Wi-Fi module:

- View a 24/7 activity feed and receive real-time notifications, so you know who had access and when.
- Know that your home and belongings are secured from anywhere.

*App requires iOS or Android smartphones for installation, guest management and remote access. For use in US and Canada only.



Wi-Fi module allows your lock to communicate with the Yale Access app.

Move Over Keys! Say Hello to the Fingerprint Lock

Meet our newest door lock: the Emtex EMPOWERED™ 2. Our locks are now even smarter and more convenient with biometric capabilities built-in. It's time for your key to become nothing more than a back-up.



NEW FEATURE

Your fingerprint. The key you'll never lose.

Locking & unlocking your door is now even more convenient using just your fingerprint.

99% Fingerprint Accuracy **<0.5** sec Recognition Time

With a 99% accuracy and <0.5 seconds recognition time, your fingerprint is the fastest and most secure way to unlock your home.

Backlit Keypad

Capacitive touchscreen keypad wakes with a touch and has numbers that won't wear off.

Weather Protection

Rubber gasket increases protection against outdoor environments.

Motorized Operation

Quiet motor with tapered deadbolt that accommodates for misaligned doors.

Smart Lock Upgrade

Seamlessly upgrade any Emtex brass tubular entry set, sideplate, or deadbolt into a smart-enabled lock.



Key-Free



Keyed



Smart Lock Upgrade

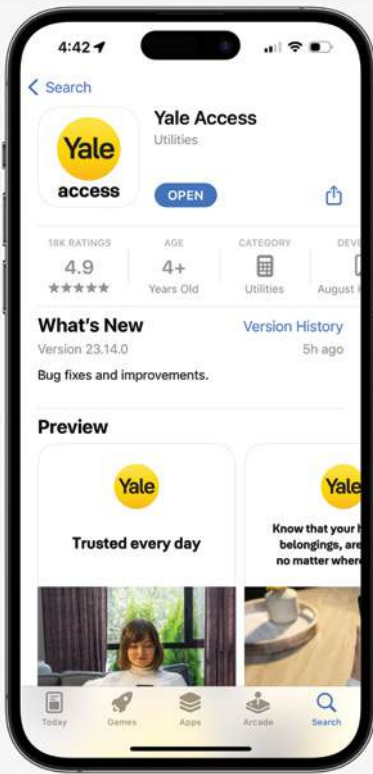

Yale Access App is available on



*App requires iOS or Android smartphones for installation, guest management and remote access. For use in US and Canada only.



Unlock your way

Key-free access with keypad, Yale Access app on your smartphone, Auto-Unlock (optional) or with a simple key.



Expecting company?

No more hidden keys. Send custom entry codes to your loved ones and service people.



Don't worry, it's locked

With Auto-Lock, you don't need to remember to lock the door.

Still the Smartest Lock Ever - Now, with Even More to Offer

Keep all the features you love from the original EMPOWERED™, like auto-lock with DoorSense™ technology, shared guest access with custom entry codes, and more! Plus, get remote access from anywhere in the world when you upgrade to Wi-Fi.

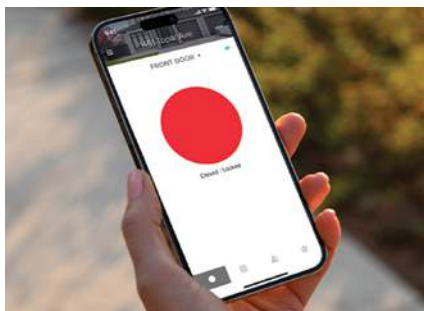

Auto-Unlock

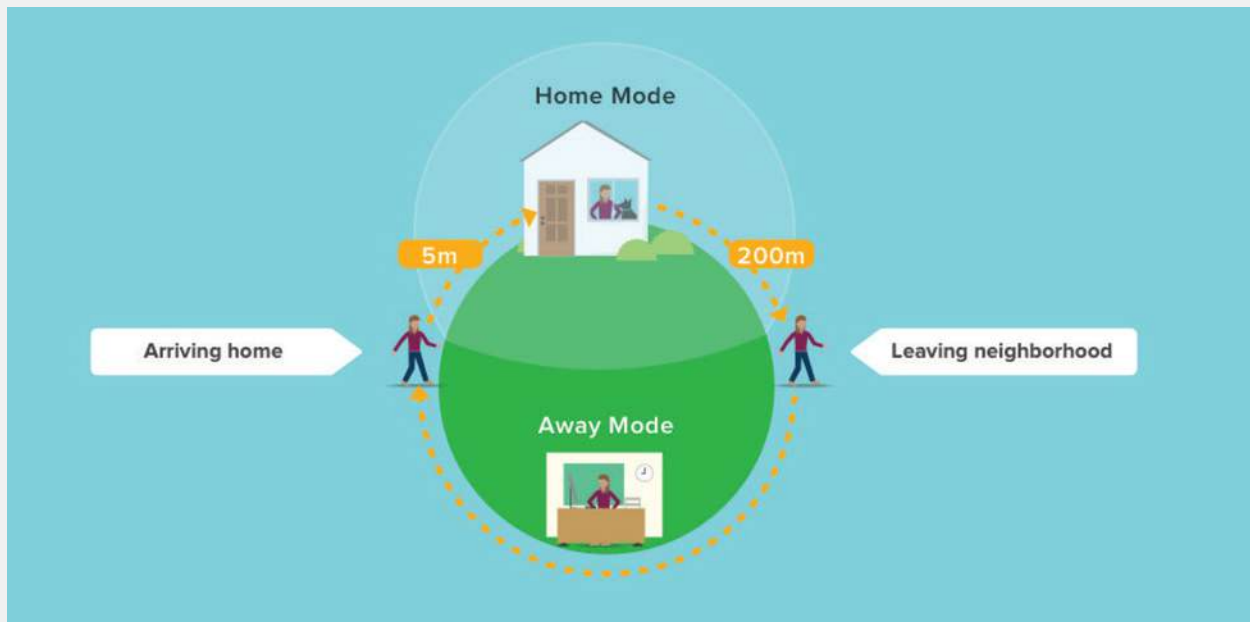

Auto-Unlock provides added convenience when you arrive home and relies on your phone's Bluetooth, Wi-Fi and GPS to know if you're home or away.

Yale Access uses two modes to enable Auto-Unlock to function: **Home Mode** and **Away Mode**. These modes indicate where Auto-Unlock thinks you are: at home or away from home.

When you are at home (in **Home Mode**), Auto-Unlock is not actively doing anything. It is waiting until you leave home.

When you approach your door, Auto-Unlock will unlock your door via Bluetooth. This means Auto-Unlock cannot operate your lock when you are away from home.

You are considered away from home when you leave your immediate neighborhood, which is about 200 meters, or a couple city blocks. It is only active when you return to your home area.

Works With

EMPowered™ 2 smart locks work in harmony with some of your favorite smart home brands to make life more simple and secure.

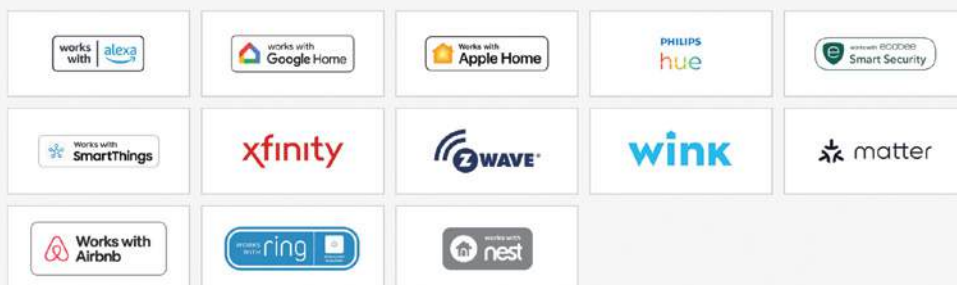

All partner integrations work with Wi-Fi smart lock models. Bluetooth lock models only work with Apple Home and exclude other partner integrations.

**EMPowered™ 2
Touch Key-Free
Deadbolt**



**EMPowered™ 2
Touch Keyed
Deadbolt**



**EMPowered™ 2
Touch Key-Free
Entry Set**



**EMPowered™ 2
Touch Keyed
Entry Set**



Available with or without Wi-Fi

**EMPowered™ 2
Smart Lock Upgrade
Entry Set**



**EMPowered™ 2
Smart Lock Upgrade
Deadbolt**



**EMPowered™ 2
Smart Lock Upgrade
Sideplate**



Available with Wi-Fi

EMPowered™ 2 Touch Key-Free Entry Set with Hercules Smooth Grip



EMPowered™ 2 Touch Keyed Entry Set with Hercules Knurled Grip



EMPOWERED™ 2 TOUCH ENTRY SET WITH HERCULES SMOOTH GRIP	Product Code	Knob or Lever Style for Inside Trim	Finish	List Price
Key-Free, Bluetooth	EMP20207	See Pages 10-23 for Brass Knob & Lever Options.	Satin Brass (US4) Oil Rubbed Bronze (US10B) Polished Nickel - Lifetime (US14) Satin Nickel (US15) Flat Black (US19) Polished Chrome (US26) Unlacquered Brass (US3NL)	\$891
Key-Free, Bluetooth & Wi-Fi*	EMP21217			\$989
Keyed, Bluetooth	EMP22227			\$891
Keyed, Bluetooth & Wi-Fi*	EMP23237			\$989
EMPOWERED™ 2 TOUCH ENTRY SET WITH HERCULES KNURLED GRIP	Product Code			List Price
Key-Free, Bluetooth	EMP20208			\$891
Key-Free, Bluetooth & Wi-Fi*	EMP21218			\$989
Keyed, Bluetooth	EMP22228			\$891
Keyed, Bluetooth & Wi-Fi*	EMP23238	\$989		

*Includes Yale Access Module, Wi-Fi Bridge and DoorSense™. For use in the US and Canada only, see pages 28-33 for details.

- **Handing Required if Lever Used on Inside Trim. Specify Exterior or Interior for Split Finish.**
- Standard door prep 2⅞" bore. Fits standard door thickness of 1¾". Specify if thicker up to 2¼".
- Complete set includes both 2⅞" and 2¾" latches, strike plates and four (4) AA batteries.
- EMPowered™ 2 Deadbolt only available with square corner latch face plate.
- Emtek's standard mechanical and finish warranties apply, along with a two (2) year warranty on electronic components.

Weiser® (WR5) Keyway

- Specify by adding "W" to the beginning of product code.
- No upcharge for cylinder substitution.
- Can be keyed into existing Weiser® system.

EMPowered™ 2 Touch Key-Free Entry Set with Baden Grip



EMPowered™ 2 Touch Keyed Entry Set with Ares Grip



EMPOWERED™ 2 TOUCH ENTRY SET WITH BADEN GRIP		Product Code	Knob or Lever Style for Inside Trim	Finish	List Price	
Key-Free, Bluetooth	EMP20203	See Pages 10-23 for Brass Knob & Lever Options.		Satin Brass (US4) Oil Rubbed Bronze (US10B) Polished Nickel - Lifetime (US14) Satin Nickel (US15) Flat Black (US19) Polished Chrome (US26) Unlacquered Brass (US3NL)	\$891	
Key-Free, Bluetooth & Wi-Fi*	EMP21213				\$989	
Keyed, Bluetooth	EMP22223				\$891	
Keyed, Bluetooth & Wi-Fi*	EMP23233				\$989	
EMPOWERED™ 2 TOUCH ENTRY SET WITH ARES GRIP					Product Code	List Price
Key-Free, Bluetooth	EMP20204				\$891	
Key-Free, Bluetooth & Wi-Fi*	EMP21214				\$989	
Keyed, Bluetooth	EMP22224				\$891	
Keyed, Bluetooth & Wi-Fi*	EMP23234	\$989				

*Includes Yale Access Module, Wi-Fi Bridge and DoorSense™. For use in the US and Canada only, see pages 28-33 for details.

• Handing Required if Lever Used on Inside Trim. Specify Exterior or Interior for Split Finish.

- Standard door prep 2 1/8" bore. Fits standard door thickness of 1 3/4". Specify if thicker up to 2 1/4".
- Complete set includes both 2 3/8" and 2 3/4" latches, strike plates and four (4) AA batteries.
- EMPowered™ 2 Deadbolt only available with square corner latch face plate.
- Emtek's standard mechanical and finish warranties apply, along with a two (2) year warranty on electronic components.

Weiser® (WR5) Keyway

- Specify by adding "W" to the beginning of product code.
- No upcharge for cylinder substitution.
- Can be keyed into existing Weiser® system.

To order: (W) Product Code + Knob/Lever Style + Handing + Finish + Add Door Thickness to Comments

EMPowered™ 2 Touch Key-Free Entry Set with Franklin Grip



EMPowered™ 2 Touch Keyed Entry Set with Hamden Grip



EMPOWERED™ 2 TOUCH ENTRY SET WITH FRANKLIN GRIP	Product Code	Knob or Lever Style for Inside Trim	Finish	List Price		
Key-Free, Bluetooth	EMP20205	See Pages 10-23 for Brass Knob & Lever Options.	Satin Brass (US4) Oil Rubbed Bronze (US10B) Polished Nickel - Lifetime (US14) Satin Nickel (US15) Flat Black (US19) Polished Chrome (US26) Unlacquered Brass (US3NL)	\$891		
Key-Free, Bluetooth & Wi-Fi*	EMP21215			\$989		
Keyed, Bluetooth	EMP22225			\$891		
Keyed, Bluetooth & Wi-Fi*	EMP23235			\$989		
EMPOWERED™ 2 TOUCH ENTRY SET WITH HAMDEN GRIP	Product Code					List Price
Key-Free, Bluetooth	EMP20206					\$891
Key-Free, Bluetooth & Wi-Fi*	EMP21216					\$989
Keyed, Bluetooth	EMP22226					\$891
Keyed, Bluetooth & Wi-Fi*	EMP23236			\$989		

*Includes Yale Access Module, Wi-Fi Bridge and DoorSense™. For use in the US and Canada only, see pages 28-33 for details.

• Handing Required if Lever Used on Inside Trim. Specify Exterior or Interior for Split Finish.

- Standard door prep 2 3/8" bore. Fits standard door thickness of 1 3/4". Specify if thicker up to 2 1/4".
- Complete set includes both 2 3/8" and 2 3/4" latches, strike plates and four (4) AA batteries.
- EMPowered™ 2 Deadbolt only available with square corner latch face plate.
- Emtek's standard mechanical and finish warranties apply, along with a two (2) year warranty on electronic components.

Weiser® (WR5) Keyway

- Specify by adding "W" to the beginning of product code.
- No upcharge for cylinder substitution.
- Can be keyed into existing Weiser® system.

EMPowered™ 2 Touch Key-Free Deadbolt



EMPowered™ 2 Touch Keyed Deadbolt



EMPOWERED™ 2 TOUCH DEADBOLT	Product Code	Finish	List Price
Key-Free, Bluetooth	EMP20201	Satin Brass (US4) Oil Rubbed Bronze (US10B)	\$550
Key-Free, Bluetooth & Wi-Fi*	EMP21211	Polished Nickel - Lifetime (US14) Satin Nickel (US15) Flat Black (US19) Polished Chrome (US26) Unlacquered Brass (US3NL)	\$649
EMPOWERED™ 2 TOUCH DEADBOLT	Product Code		List Price
Keyed, Bluetooth	EMP22221		\$550
Keyed, Bluetooth & Wi-Fi*	EMP23231		\$649

*Includes Yale Access Module, Wi-Fi Bridge and DoorSense™. For use in the US and Canada only, see pages 28-33 for details.

• Handing Required if Lever Used on Inside Trim. Specify Exterior or Interior for Split Finish.

- Standard door prep 2 1/8" bore. Fits standard door thickness of 1 3/4". Specify if thicker up to 2 1/4".
- Complete set includes both 2 3/8" and 2 3/4" latches, strike plates and four (4) AA batteries.
- EMPowered™ 2 Deadbolt only available with square corner latch face plate.
- Emtek's standard mechanical and finish warranties apply, along with a two (2) year warranty on electronic components.

Weiser® (WR5) Keyway

- Specify by adding "W" to the beginning of product code.
- No upcharge for cylinder substitution.
- Can be keyed into existing Weiser® system.



Have an EMPowered™ 2 Lock without Wi-Fi?

Upgrade any EMPowered™ 2 Lock with Bluetooth® by adding the new Yale Wi-Fi Module to get even more smart features you'll love.

	Product Code	List Price
Yale Wi-Fi Module	MODULE-WIFI-EMP2-YA	\$99
Yale Wi-Fi Bridge	BRIDGE-WIFI-EMP2-YA	\$99

ELECTRONIC LOCKSETS - KEYPAD ENTRY SETS

EMTouch™ Electronic
Keypad Entry SetEMTouch™ Classic Style
Electronic Keypad Entry Set

EMTOUCH™ ELECTRONIC KEYPAD ENTRY SET	Product Code	Knob or Lever Style for Inside Trim	Finish	List Price
Single Cylinder	E4827	See Pages 10-23 for Brass Knob & Lever Options.	Satin Brass (US4)	\$730
Dummy	E4027		Oil Rubbed Bronze (US10B) Polished Nickel - Lifetime (US14) Satin Nickel (US15) Flat Black (US19) Polished Chrome (US26)	\$730

EMTOUCH™ CLASSIC STYLE ELECTRONIC KEYPAD ENTRY SET	Product Code	Knob or Lever Style for Inside Trim	Finish	List Price
Single Cylinder	E4410	See Pages 10-23 for Brass Knob & Lever Options.	Polished Brass - Lifetime (US3)	\$730
Dummy	E4010		Oil Rubbed Bronze (US10B) Satin Nickel (US15)	\$730

Product Features for Emtek Electronic Keypad Locksets:

- Factory programmed with 2 unique, 4-digit secure user codes for use right out of the box.
- Can be programmed with up to 20 user codes of your choice.
- Emtek's standard mechanical and finish warranties apply, along with a two (2) year warranty on electronic components.

EMTouch™ and all Emtek Keypad Locksets are covered by the following patents:

Canadian patents	U.S. patents
2,698,041	8,176,761
2,789,278	8,141,400
2,789,280	

• **Handing Required if Lever Used on Inside**

- Fits standard door thickness of 1¾". Specify if thicker.
- Standard door prep 2½" bore. Standard latch is for 2¾" backset. Specify 2¾" backset if required.
- Complete set includes latch, strike plate and a 9-volt battery.

• **Weiser® (WR5) Keyway**

- Specify by adding "W" to the beginning of product code.
- No upcharge for cylinder substitution.
- Can be keyed into existing Weiser® system.

Modern Style Electronic Keypad Entry Set



Sandcast Bronze Style Electronic Keypad Entry Set



MODERN STYLE ELECTRONIC KEYPAD ENTRY SET	Product Code	Knob or Lever Style for Inside Trim	Finish	List Price
Single Cylinder	E4817	See Pages 10-23 for Brass Knob & Lever Options.	Oil Rubbed Bronze (US10B) Satin Nickel (US15)	\$685
Dummy	E4017		Flat Black (US19) Polished Chrome (US26)	\$685
SANDCAST BRONZE STYLE ELECTRONIC KEYPAD ENTRY SET	Product Code	Knob or Lever Style for Inside Trim	Finish	List Price
Single Cylinder	E451211	See Pages 24-25 for Sandcast Bronze Knob & Lever Options.	Flat Black Bronze (FB) Medium Bronze (MB)	\$876
Dummy	E401211			\$876

Product Features for Emtek Electronic Keypad Locksets:

- Factory programmed with 2 unique, 4-digit secure user codes for use right out of the box.
- Can be programmed with up to 20 user codes of your choice.
- Emtek's standard mechanical and finish warranties apply, along with a two (2) year warranty on electronic components.

EMTouch™ and all Emtek Keypad Locksets are covered by the following patents:

Canadian patents	U.S. patents
2,698,041	8,176,761
2,789,278	8,141,400
2,789,280	

- **Handing Required if Lever Used on Inside**
- Fits standard door thickness of 1¾". Specify if thicker.
- Standard door prep 2½" bore. Standard latch is for 2¾" backset. Specify 2¾" backset if required.
- Complete set includes latch, strike plate and a 9-volt battery.

- **Weiser® (WR5) Keyway**
- Specify by adding "W" to the beginning of product code.
- No upcharge for cylinder substitution.
- Can be keyed into existing Weiser® system.

To order: **(W) Product Code + Knob/Lever Style + Handing + Finish + Add Door Thickness to Comments**



EMTOUCH™	Product Code	Finish	List Price
Electronic Keypad Deadbolt	E3020	Satin Brass (US4) Oil Rubbed Bronze (US10B) Polished Nickel - Lifetime (US14) Satin Nickel (US15) Flat Black (US19) Polished Chrome (US26)	\$399

* To order an adaptor for thin door (1 3/8" - 1 3/4"), add product code **KEYDBEXT** and list price \$22 Available in Flat Black (US19) only.



EMTOUCH™ CLASSIC	Product Code	Finish	List Price
Electronic Keypad Deadbolt	E3002	Polished Brass - Lifetime (US3) Oil Rubbed Bronze (US10B) Satin Nickel (US15)	\$399

* To order an adaptor for thin door (1 3/8" - 1 3/4"), add product code **KEYDBEXT** and list price \$22 Available in Flat Black (US19) only.



MODERN	Product Code	Finish	List Price
Electronic Keypad Deadbolt	E1020	Oil Rubbed Bronze (US10B) Satin Nickel (US15) Flat Black (US19) Polished Chrome (US26)	\$354

* To order an adaptor for thin door (1 3/8" - 1 3/4"), add product code **KEYDBEXT** and list price \$22 Available in Flat Black (US19) only.



CLASSIC	Product Code	Finish	List Price
Electronic Keypad Deadbolt	E1000	Polished Brass - Lifetime (US3) Oil Rubbed Bronze (US10B) Satin Nickel (US15)	\$311

* To order an adaptor for thin door (1 3/8" - 1 3/4"), add product code **KEYDBEXT** and list price \$22 Available in Flat Black (US19) only.



SANDCAST BRONZE	Product Code	Finish	List Price
Electronic Keypad Deadbolt	E1001	Flat Black Bronze (FB) Medium Bronze (MB)	\$380

* Adaptor for thin door NOT available.

STANDARD WITH KEYPAD DEADBOLT LOCKSETS

- Schlage® C Keyway
- Standard Door Prep and Installation
- Solid Brass Cylinder, Housing, Collar and Rosette
- Hardened Steel Bolt
- Brass Trim Strike
- Heavy Gauge Steel Understrike

• Handing Not Required

- Fits standard door thickness of 1 3/4". Specify if thicker.
- Standard door prep 2 3/8" bore. Standard latch is for 2 3/8" backset. Specify 2 3/4" backset if required.
- Complete set includes latch, strike plate and a 9-volt battery.
- Emtek's standard mechanical and finish warranties apply, along with a two (2) year warranty on electronic components.

Weiser® (WR5) Keyway

- Specify by adding "W" to the beginning of product code.
- No upcharge for cylinder substitution.
- Can be keyed into existing Weiser® system.



EMTOUCH™	Product Code	Lever Style	Finish	List Price
Keypad Leverset	E4020	See Pages 10-23 for Brass Lever Options.	Satin Brass (US4) Oil Rubbed Bronze (US10B)	\$464
Keypad Leverset with Storeroom/Gate Function	E4220		Polished Nickel - Lifetime (US14) Satin Nickel (US15) Flat Black (US19) Polished Chrome (US26)	\$464

* To order an adaptor for thin door (1 3/8" - 1 5/8"), add product code **KEYLVREXT** and list price \$22 Available in Flat Black (US19) only.



EMTOUCH™ CLASSIC	Product Code	Lever Style	Finish	List Price
Keypad Leverset	E4002	See Pages 10-23 for Brass Lever Options.	Polished Brass - Lifetime (US3) Oil Rubbed Bronze (US10B)	\$464
Keypad Leverset with Storeroom/Gate Function	E4202		Satin Nickel (US15)	\$464

* To order an adaptor for thin door (1 3/8" - 1 5/8"), add product code **KEYLVREXT** and list price \$22 Available in Flat Black (US19) only.



MODERN	Product Code	Lever Style	Finish	List Price
Keypad Leverset	E2020	See Pages 10-23 for Brass Lever Options.	Oil Rubbed Bronze (US10B) Satin Nickel (US15)	\$419
Keypad Leverset with Storeroom/Gate Function	E2220		Flat Black (US19) Polished Chrome (US26)	\$419

* To order an adaptor for thin door (1 3/8" - 1 5/8"), add product code **KEYLVREXT** and list price \$22 Available in Flat Black (US19) only.



CLASSIC	Product Code	Lever Style	Finish	List Price
Keypad Leverset	E2000	See Pages 10-23 for Brass Lever Options.	Polished Brass - Lifetime (US3) Oil Rubbed Bronze (US10B)	\$394
Keypad Leverset with Storeroom/Gate Function	E2200		Satin Nickel (US15)	\$394

* To order an adaptor for thin door (1 3/8" - 1 5/8"), add product code **KEYLVREXT** and list price \$22 Available in Flat Black (US19) only.



SANDCAST BRONZE	Product Code	Lever Style	Finish	List Price
Keypad Leverset	E2001	See Pages 24-25 for Sandcast Bronze Lever Options.	Flat Black Bronze (FB) Medium Bronze (MB)	\$450
Keypad Leverset with Storeroom/Gate Function	E2201		\$450	

* Adaptor for thin door NOT available.



Passage Function in Locked Mode

- Outside lever always locked
- Entry by code or key only
- Inside lever always free



Passage Function in Passage Mode

- Outside lever always free
- Entry by operating lever, no code or key require
- Inside lever always free



Storeroom Function

- Outside lever always locked
- Entry by code or key only
- Inside lever always free

• Handing Required For Leversets

- Fits standard door thickness of 1 3/4". Specify if thicker.
- Standard door prep 2 1/8" bore. Standard latch is for 2 3/4" backset. Specify 2 3/4" backset if required.
- Complete set includes latch, strike plate and a 9-volt battery.
- Emtek's standard mechanical and finish warranties apply, along with a two (2) year warranty on electronic components.

Weiser® (WR5) Keyway

- Specify by adding "W" to the beginning of product code.
- No upcharge for cylinder substitution.
- Can be keyed into existing Weiser® system.

To order: **(W) Product Code + Lever Style + Handing + Finish + Add Door Thickness to Comments**

ANSI F20 UL LISTED HEAVY DUTY LOCK BODY

ALWAYS LOCKED ON THE OUTSIDE

ANSI F13 UL LISTED HEAVY DUTY LOCK BODY

OPERATES AS A STANDARD KEYED LOCK

F20 Mortise Lock Box

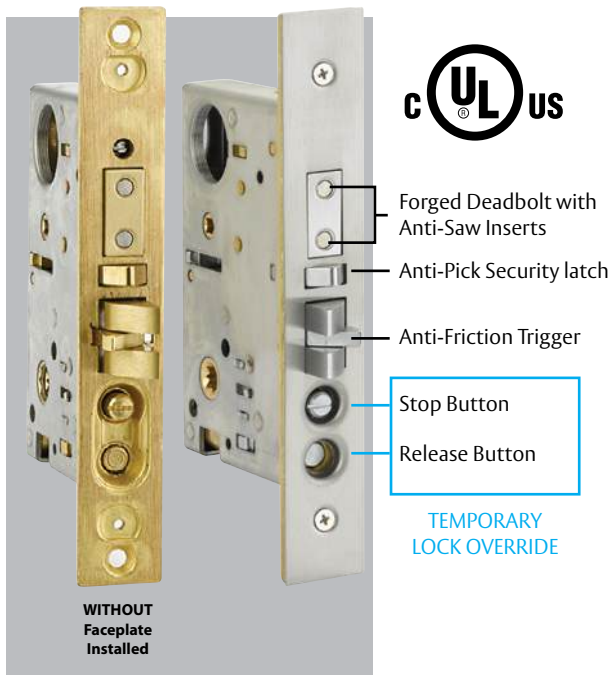

F13 Mortise Lock Box

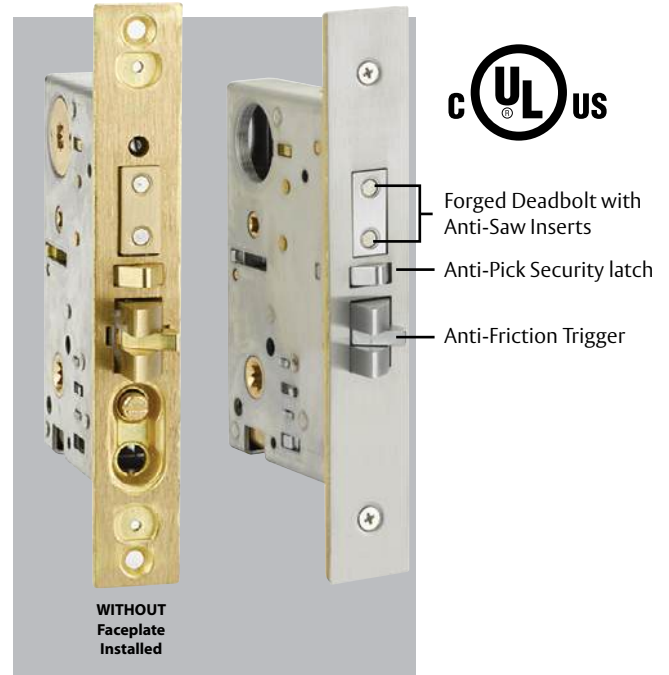

F20 has a mechanism to temporarily override the outside lock that can be activated by pressing the release button. To cancel, use the stop button or project the deadbolt

HOW TO ORDER

Add **FUNCTION** to the Product Code, Backset, Lever/Knob, Handing and Finish. For example:

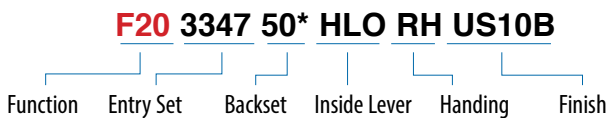

*50 = 2 1/2" Backset and 75 = 2 3/4" Backset

MORTISE LOCK FEATURES

- UL Listed Mortise Door Prep ANSI A115.1
- UL180 minute fire rating
- Heavy duty lock body
- Forged deadbolt latch with Anti-Saw inserts
- Anti-Friction latch trigger
- Deadlocking latch bolt
- Key outside operates both bolts
- Inside lever retracts latch and deadbolt simultaneously

**Hercules Smooth
Monolithic Mortise
ANSI F20**



**Hercules Smooth
Full Length Mortise
ANSI F13**



Order any brass knob or lever for the inside trim.

**ANSI F20
Function**

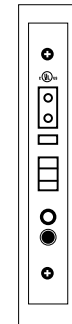

**ANSI F13
Function**



Hercules Smooth Monolithic Mortise		Product Code	Backset	Knob or Lever Style for Inside Trim	Handing	Finish	List Price
Entry Set	Specify F20 or F13 Function	3335	2½" or 2¾"	See Pages 10-23 for Brass Knob & Lever Options.	LH/RH	Satin Brass (US4) Oil Rubbed Bronze (US10B) Polished Nickel - Lifetime (US14) Satin Nickel (US15) Flat Black (US19) Polished Chrome (US26) Unlacquered Brass (US3NL)*	\$939
Dummy	N/A	3035	N/A				\$624
Hercules Smooth Full Length Mortise		Product Code	Backset				List Price
Entry Set	Specify F20 or F13 Function	3336	2½" or 2¾"				\$1023
Dummy	N/A	3036	N/A	\$710			

- Handing is Required for ALL Mortise Locks
- Standard door thickness of 1¾". Specify if thicker.
- Locks for in-swing doors are standard. For out-swing doors, please specify.

*Unlacquered Brass (US3NL) finish available for a \$25 List Price upcharge per item.

To order: **Function + Product Code + Backset + Knob/Lever Style + Handing + Finish + Add Door Thickness to Comments**

**Hercules Knurled
Monolithic Mortise
ANSI F20**



**Hercules Knurled
Full Length Mortise
ANSI F13**



Order any brass knob or lever for the inside trim.

**ANSI F20
Function**

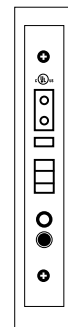

**ANSI F13
Function**

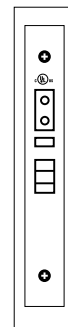

Hercules Knurled Monolithic Mortise		Product Code	Backset	Knob or Lever Style for Inside Trim	Handing	Finish	List Price
Entry Set	Specify F20 or F13 Function	3337	2½" or 2¾"	See Pages 10-23 for Brass Knob & Lever Options.	LH/RH	Satin Brass (US4) Oil Rubbed Bronze (US10B) Polished Nickel - Lifetime (US14) Satin Nickel (US15) Flat Black (US19) Polished Chrome (US26) Unlacquered Brass (US3NL)*	\$939
Dummy	N/A	3037	N/A				\$624
Hercules Knurled Full Length Mortise		Product Code	Backset				List Price
Entry Set	Specify F20 or F13 Function	3338	2½" or 2¾"				\$1023
Dummy	N/A	3038	N/A				\$710

- Handing is Required for ALL Mortise Locks
- Standard door thickness of 1¾". Specify if thicker.
- Locks for in-swing doors are standard. For out-swing doors, please specify.

*Unlacquered Brass (US3NL) finish available for a \$25 List Price upcharge per item.

**Mormont Mortise
ANSI F20**



**Lugano Mortise
ANSI F13**



Order any brass knob or lever for the inside trim.

ANSI F20 Function **ANSI F13 Function**

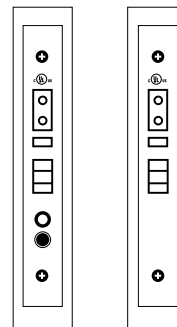

MORMONT MORTISE		Product Code	Backset	Knob or Lever Style for Inside Trim	Handing	Finish	List Price
Entry Set	Specify F20 or F13 Function	3347	2½" or 2¾"	See Pages 10-23 for Brass Knob & Lever Options.	LH/RH	Satin Brass (US4) Oil Rubbed Bronze (US10B) Polished Nickel - Lifetime (US14) Satin Nickel (US15) Flat Black (US19) Polished Chrome (US26) Unlacquered Brass (US3NL)*	\$939
Dummy	N/A	3047	N/A				\$624
LUGANO MORTISE		Product Code	Backset				List Price
Entry Set	Specify F20 or F13 Function	3348	2½" or 2¾"				\$1023
Dummy	N/A	3048	N/A				\$710

- **Handing is Required for ALL Mortise Locks**
- Standard door thickness of 1¾". Specify if thicker.
- Locks for in-swing doors are standard. For out-swing doors, please specify.

*Unlacquered Brass (US3NL) finish available for a \$25 List Price upcharge per item.

To order: **Function + Product Code + Backset + Knob/Lever Style + Handing + Finish + Add Door Thickness to Comments**

**Brisbane Mortise
ANSI F20**



**Adelaide Mortise
ANSI F13**



Order any brass knob or lever for the inside trim.

**ANSI F20
Function**

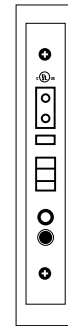

**ANSI F13
Function**

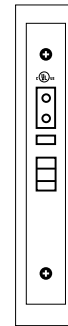

BRISBANE MORTISE		Product Code	Backset	Knob or Lever Style for Inside Trim	Handing	Finish	List Price
Entry Set	Specify F20 or F13 Function	3311	2½" or 2¾"	See Pages 10-23 for Brass Knob & Lever Options.	LH/RH	Satin Brass (US4) Oil Rubbed Bronze (US10B) Polished Nickel - Lifetime (US14) Satin Nickel (US15) Flat Black (US19) Polished Chrome (US26) Unlacquered Brass (US3NL)*	\$939
Dummy	N/A	3017	N/A				\$624
ADELAIDE MORTISE		Product Code	Backset				List Price
Entry Set	Specify F20 or F13 Function	3312	2½" or 2¾"				\$1023
Dummy	N/A	3018	N/A				\$710

- Handing is Required for ALL Mortise Locks
- Standard door thickness of 1¾". Specify if thicker.
- Locks for in-swing doors are standard. For out-swing doors, please specify.

*Unlacquered Brass (US3NL) finish available for a \$25 List Price upcharge per item.

**Artemis Mortise
ANSI F20**



**Hera Mortise
ANSI F13**



Order any brass knob or lever for the inside trim.

**ANSI F20
Function**



**ANSI F13
Function**

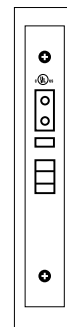

ARTEMIS MORTISE		Product Code	Backset	Knob or Lever Style for Inside Trim	Handing	Finish	List Price
Entry Set	Specify F20 or F13 Function	3344	2½" or 2¾"				
Dummy	N/A	3044	N/A	\$624			
HERA MORTISE		Product Code	Backset				List Price
Entry Set	Specify F20 or F13 Function	3345	2½" or 2¾"				\$1023
Dummy	N/A	3045	N/A	\$710			

- Handing is Required for ALL Mortise Locks
- Standard door thickness of 1¾". Specify if thicker.
- Locks for in-swing doors are standard. For out-swing doors, please specify.

*Unlacquered Brass (US3NL) finish available for a \$25 List Price upcharge per item.

To order: **Function + Product Code + Backset + Knob/Lever Style + Handing + Finish + Add Door Thickness to Comments**

**Manhattan Mortise
ANSI F20**



**Melrose Mortise
ANSI F13**



Order any brass knob or lever for the inside trim.

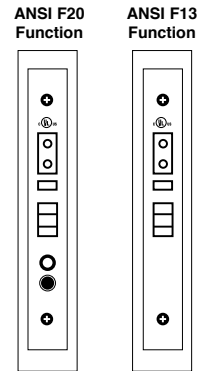

MANHATTAN MORTISE		Product Code	Backset	Knob or Lever Style for Inside Trim	Handing	Finish	List Price
Entry Set	Specify F20 or F13 Function	3306	2½" or 2¾"	See Pages 10-23 for Brass Knob & Lever Options.	LH/RH	Polished Brass - Lifetime (US3) French Antique (US7) Oil Rubbed Bronze (US10B) Polished Nickel - Lifetime (US14) Satin Nickel (US15) Pewter (US15A) Flat Black (US19) Polished Chrome (US26) Unlacquered Brass (US3NL)*	\$939
Dummy	N/A	3006	N/A				\$624
MELROSE MORTISE		Product Code	Backset				List Price
Entry Set	Specify F20 or F13 Function	3305	2½" or 2¾"				\$1023
Dummy	N/A	3005	N/A				\$710

- Handing is Required for ALL Mortise Locks
- Standard door thickness of 1¾". Specify if thicker.
- Locks for in-swing doors are standard. For out-swing doors, please specify.

*Unlacquered Brass (US3NL) finish available for a \$25 List Price upcharge per item.

**Harrison Mortise
ANSI F20**



**Middleton Mortise
ANSI F13**



Order any brass knob or lever for the inside trim.

**ANSI F20
Function**

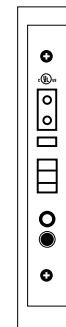

**ANSI F13
Function**



HARRISON MORTISE		Product Code	Backset	Knob or Lever Style for Inside Trim	Handing	Finish	List Price
Entry Set	Specify F20 or F13 Function	3351	2½" or 2¾"	See Pages 10-23 for Brass Knob & Lever Options.	LH/RH	Polished Brass - Lifetime (US3) French Antique (US7) Oil Rubbed Bronze (US10B) Polished Nickel - Lifetime (US14) Satin Nickel (US15) Pewter (US15A) Flat Black (US19) Polished Chrome (US26) Unlacquered Brass (US3NL)*	\$939
Dummy	N/A	3051	N/A				\$624
MIDDLETON MORTISE		Product Code	Backset				List Price
Entry Set	Specify F20 or F13 Function	3352	2½" or 2¾"	\$1023			
Dummy	N/A	3052	N/A	\$710			

- Handing is Required for ALL Mortise Locks
- Standard door thickness of 1¾". Specify if thicker.
- Locks for in-swing doors are standard. For out-swing doors, please specify.

*Unlacquered Brass (US3NL) finish available for a \$25 List Price upcharge per item.

To order: **Function + Product Code + Backset + Knob/Lever Style + Handing + Finish** + Add Door Thickness to Comments

**Transitional
Heritage Mortise
ANSI F20**



Order any brass knob or lever for the inside trim.

**Memphis Mortise
ANSI F13**



Order any brass knob or lever for the inside trim.

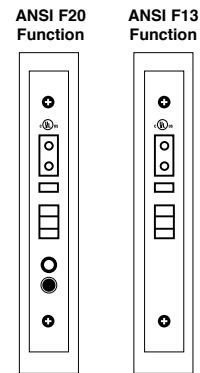

TRANSITIONAL HERITAGE MORTISE		Product Code	Backset	Knob or Lever Style for Inside Trim	Handing	Finish	List Price
Entry Set	Specify F20 or F13 Function	3339	2½" or 2¾"	See Pages 10-23 for Brass Knob & Lever Options.	LH/RH	Satin Brass (US4) Oil Rubbed Bronze (US10B) Polished Nickel - Lifetime (US14) Satin Nickel (US15) Flat Black (US19) Polished Chrome (US26) Unlacquered Brass (US3NL)*	\$939
Dummy	N/A	3039	N/A			Polished Brass - Lifetime (US3) French Antique (US7) Oil Rubbed Bronze (US10B) Polished Nickel - Lifetime (US14) Satin Nickel (US15) Pewter (US15A) Flat Black (US19) Polished Chrome (US26) Unlacquered Brass (US3NL)*	\$624
MEMPHIS MORTISE		Product Code	Backset				List Price
Entry Set	Specify F20 or F13 Function	3302	2½" or 2¾"			Polished Brass - Lifetime (US3) French Antique (US7) Oil Rubbed Bronze (US10B) Polished Nickel - Lifetime (US14) Satin Nickel (US15) Pewter (US15A) Flat Black (US19) Polished Chrome (US26) Unlacquered Brass (US3NL)*	\$939
Dummy	N/A	3002	N/A			Polished Brass - Lifetime (US3) French Antique (US7) Oil Rubbed Bronze (US10B) Polished Nickel - Lifetime (US14) Satin Nickel (US15) Pewter (US15A) Flat Black (US19) Polished Chrome (US26) Unlacquered Brass (US3NL)*	\$624

- Handing is Required for ALL Mortise Locks
- Standard door thickness of 1¾". Specify if thicker.
- Locks for in-swing doors are standard. For out-swing doors, please specify.

*Unlacquered Brass (US3NL) finish available for a \$25 List Price upcharge per item.

**Charleston Mortise
ANSI F20**



**Albany Mortise
ANSI F13**



Order any brass knob or lever for the inside trim.

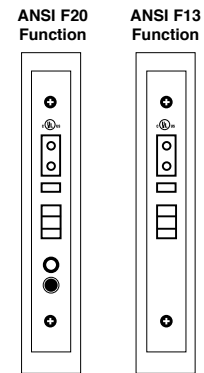

CHARLESTON MORTISE		Product Code	Backset	Knob or Lever Style for Inside Trim	Handing	Finish	List Price
Entry Set	Specify F20 or F13 Function	3343	2½" or 2¾"	See Pages 10-23 for Brass Knob & Lever Options.	LH/RH	Polished Brass - Lifetime (US3) French Antique (US7) Oil Rubbed Bronze (US10B) Polished Nickel - Lifetime (US14) Satin Nickel (US15) Pewter (US15A) Flat Black (US19) Polished Chrome (US26) Unlacquered Brass (US3NL)*	\$939
Dummy	N/A	3043	N/A				\$624
ALBANY MORTISE		Product Code	Backset				List Price
Entry Set	Specify F20 or F13 Function	3350	2½" or 2¾"				\$1023
Dummy	N/A	3050	N/A				\$710

- Handing is Required for ALL Mortise Locks
- Standard door thickness of 1¾". Specify if thicker.
- Locks for in-swing doors are standard. For out-swing doors, please specify.

*Unlacquered Brass (US3NL) finish available for a \$25 List Price upcharge per item.

To order: **Function + Product Code + Backset + Knob/Lever Style + Handing + Finish + Add Door Thickness to Comments**

**Regency Mortise
ANSI F20**



**Versailles Mortise
ANSI F13**



Order any brass knob or lever for the inside trim.

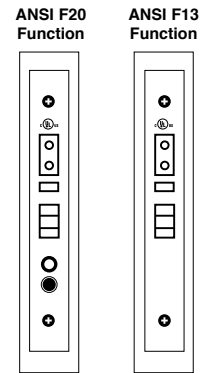

REGENCY MORTISE		Product Code	Backset	Knob or Lever Style for Inside Trim	Handing	Finish	List Price
Entry Set	Specify F20 or F13 Function	3307	2½" or 2¾"	See Pages 10-23 for Brass Knob & Lever Options.	LH/RH	Polished Brass - Lifetime (US3) French Antique (US7) Oil Rubbed Bronze (US10B) Satin Nickel (US15) Pewter (US15A) Polished Chrome (US26) Unlacquered Brass (US3NL)*	\$939
Dummy	N/A	3007	N/A				\$624
VERSAILLES MORTISE		Product Code	Backset				List Price
Entry Set	Specify F20 or F13 Function	3309	2½" or 2¾"				\$1023
Dummy	N/A	3009	N/A				\$710

- Handing is Required for ALL Mortise Locks
- Standard door thickness of 1¾". Specify if thicker.
- Locks for in-swing doors are standard. For out-swing doors, please specify.

*Unlacquered Brass (US3NL) finish available for a \$25 List Price upcharge per item.

Craftsman Mortise
ANSI F20



Craftsman Full Length Mortise
ANSI F13



Order any brass knob or lever for the inside trim.

ANSI F20 Function

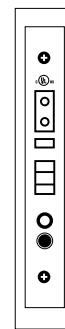

ANSI F13 Function

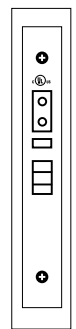

CRAFTSMAN MORTISE		Product Code	Backset	Knob or Lever Style for Inside Trim	Handing	Finish	List Price
Entry Set	Specify F20 or F13 Function	3308	2½" or 2¾"	See Pages 10-23 for Brass Knob & Lever Options.	LH/RH	Oil Rubbed Bronze (US10B) Satin Nickel (US15) Flat Black (US19) Unlacquered Brass (US3NL)*	\$939
Dummy	N/A	3008	N/A				\$624
CRAFTSMAN FULL LENGTH MORTISE		Product Code	Backset				List Price
Entry Set	Specify F20 or F13 Function	3349	2½" or 2¾"				\$1023
Dummy	N/A	3049	N/A				\$710

- Handing is Required for ALL Mortise Locks
- Standard door thickness of 1¾". Specify if thicker.
- Locks for in-swing doors are standard. For out-swing doors, please specify.

*Unlacquered Brass (US3NL) finish available for a \$25 List Price upcharge per item.

To order: **Function + Product Code + Backset + Knob/Lever Style + Handing + Finish** + Add Door Thickness to Comments

**Sonoma Mortise
ANSI F20**



**Longmont Mortise
ANSI F13**



Order any sandcast bronze knob or lever for the inside trim.

**Rustic Modern
Rectangular Mortise
ANSI F20**



Order any sandcast bronze knob or lever for the inside trim.

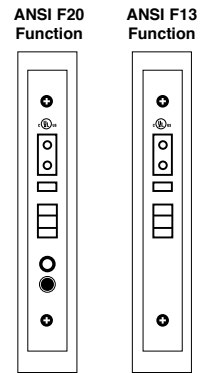

SONOMA MORTISE		Product Code	Backset	Knob or Lever Style for Inside Trim	Handing	Finish	List Price
Entry Set	Specify F20 or F13 Function	3329	2½" or 2¾"	See Pages 24-25 for Sandcast Bronze Knob & Lever Options.	LH/RH	Flat Black Bronze (FB) Medium Bronze (MB) Tumbled White Bronze (TWB)	\$1040
Dummy	N/A	3029	N/A				See Pages 22-23 for Glass & Porcelain Knob Options.
LONGMONT MORTISE		Product Code	Backset				List Price
Entry Set	Specify F20 or F13 Function	3330	2½" or 2¾"				\$1127
Dummy	N/A	3030	N/A				\$813
RUSTIC MODERN RECTANGULAR MORTISE		Product Code	Backset				List Price
Entry Set	Specify F20 or F13 Function	3340	2½" or 2¾"				\$1040
Dummy	N/A	3040	N/A				\$726

- Handing is Required for ALL Mortise Locks
- Standard door thickness of 1¾". Specify if thicker.
- Locks for in-swing doors are standard. For out-swing doors, please specify.

**Rectangular Sectional Mortise
ANSI F20**



**Rectangular Monolithic Mortise
ANSI F20**



**Rectangular Full Length Mortise
ANSI F13**



Order any sandcast bronze knob or lever for the Inside trim.

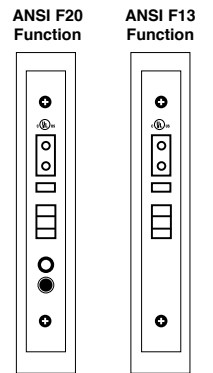

RECTANGULAR SECTIONAL MORTISE		Product Code	Backset	Knob or Lever Style for Inside Trim	Handing	Finish	List Price
Entry Set	Specify F20 or F13 Function	3324	2½" or 2¾"	See Pages 24-25 for Sandcast Bronze Knob & Lever Options.	LH/RH	Flat Black Bronze (FB) Medium Bronze (MB) Tumbled White Bronze (TWB)	\$973
Dummy	N/A	3024	N/A				See Pages 22-23 for Glass & Porcelain Knob Options.
RECTANGULAR MONOLITHIC MORTISE		Product Code	Backset				List Price
Entry Set	Specify F20 or F13 Function	3325	2½" or 2¾"				\$1040
Dummy	N/A	3025	N/A				\$726
RECTANGULAR FULL LENGTH MORTISE		Product Code	Backset				List Price
Entry Set	Specify F20 or F13 Function	3326	2½" or 2¾"				\$1127
Dummy	N/A	3026	N/A				\$813

- **Handing is Required for ALL Mortise Locks**
- Standard door thickness of 1¾". Specify if thicker.
- Locks for in-swing doors are standard. For out-swing doors, please specify.

To order: **Function + Product Code + Backset + Knob/Lever Style + Handing + Finish + Add Door Thickness to Comments**

Denver Mortise
ANSI F20



Cheyenne Mortise
ANSI F20



Topeka Mortise
ANSI F13



Order any sandcast bronze knob or lever for the Inside trim.

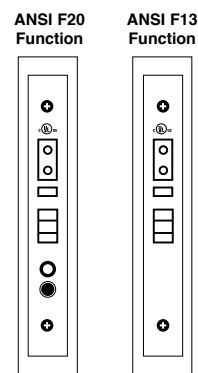

DENVER MORTISE		Product Code	Backset	Knob or Lever Style for Inside Trim	Handing	Finish	List Price	
Entry Set	Specify F20 or F13 Function	3323	2½" or 2¾"	See Pages 24-25 for Sandcast Bronze Knob & Lever Options.	LH/RH	Flat Black Bronze (FB) Medium Bronze (MB) Tumbled White Bronze (TWB)	\$973	
Dummy	N/A	3023	N/A				See Pages 22-23 for Glass & Porcelain Knob Options.	\$658
CHEYENNE MORTISE		Product Code	Backset					List Price
Entry Set	Specify F20 or F13 Function	3321	2½" or 2¾"				\$1040	
Dummy	N/A	3021	N/A				\$726	
TOPEKA MORTISE		Product Code	Backset					List Price
Entry Set	Specify F20 or F13 Function	3322	2½" or 2¾"		\$1127			
Dummy	N/A	3022	N/A		\$813			

- Handing is Required for ALL Mortise Locks
- Standard door thickness of 1¾". Specify if thicker.
- Locks for in-swing doors are standard. For out-swing doors, please specify.

**Octagon Mortise
ANSI F20**



Order any Tuscany Bronze knob or lever for the inside trim.

**Da Vinci Mortise
ANSI F13**



Order any Tuscany Bronze knob or lever for the inside trim.

**ANSI F20
Function**



**ANSI F13
Function**

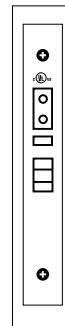

OCTAGON MORTISE		Product Code	Backset	Knob or Lever Style for Inside Trim	Handing	Finish	List Price
Entry Set	Specify F20 or F13 Function	3333	2½" or 2¾"	See Pages 24-25 for Tuscany Bronze Knob & Lever Options.	LH/RH	Flat Black Bronze (FB) Medium Bronze (MB)	\$1040
Dummy	N/A	3033	N/A				\$726
DA VINCI MORTISE		Product Code	Backset				List Price
Entry Set	Specify F20 or F13 Function	3331	2½" or 2¾"				\$1040
Dummy	N/A	3031	N/A				\$726

- **Handing is Required for ALL Mortise Locks**
- Standard door thickness of 1¾". Specify if thicker.
- Locks for in-swing doors are standard. For out-swing doors, please specify.

To order: **Function + Product Code + Backset + Knob/Lever Style + Handing + Finish + Add Door Thickness to Comments**

**Mormont
Stainless Steel Mortise
ANSI F20**

**Mormont
Stainless Steel Mortise
ANSI F13**



Order any stainless steel knob or lever for the inside trim.

**ANSI F20
Function**



**ANSI F13
Function**

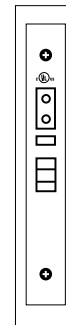

MORMONT STAINLESS STEEL MORTISE		Product Code	Backset	Knob or Lever Style for Inside Trim	Handing	Finish	List Price
Entry Set	Specify F20 or F13 Function	S3301	2½" or 2¾"	See Pages 26-27 for Stainless Steel Knob & Lever Options.	LH/RH	Brushed Stainless Steel (SS)	\$939
Dummy	N/A	S3001	N/A				\$624

- **Handing is Required for ALL Mortise Locks**
- Standard door thickness of 1¾". Specify if thicker.
- Locks for in-swing doors are standard. For out-swing doors, please specify.

**Mormont Mortise
ANSI F20**



**Artemis Mortise
ANSI F20**



**Brisbane Mortise
ANSI F13**



Interior trim view

**ANSI F20
Function**



**ANSI F13
Function**

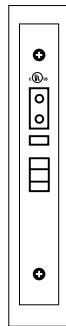

MORMONT MORTISE		Product Code	Backset	Knob or Lever Style	Handing	Finish	List Price
Entry Set	Specify F20 or F13 Function	3545	2 1/2" or 2 3/4"	See Pages 10-23 for Brass Knob & Lever Options.	LH/RH	Satin Brass (US4) Oil Rubbed Bronze (US10B) Polished Nickel - Lifetime (US14) Satin Nickel (US15) Flat Black (US19) Polished Chrome (US26) Unlacquered Brass (US3NL)*	\$868
Dummy	N/A	3145	N/A				\$557
ARTEMIS MORTISE		Product Code	Backset				List Price
Entry Set	Specify F20 or F13 Function	3544	2 1/2" or 2 3/4"	\$868			
Dummy	N/A	3144	N/A	\$557			
BRISBANE MORTISE		Product Code	Backset	List Price			
Entry Set	Specify F20 or F13 Function	3313	2 1/2" or 2 3/4"	\$868			
Dummy	N/A	3019	N/A	\$557			

- Handing is Required for ALL Mortise Locks
- Standard door thickness of 1 3/4". Specify if thicker.
- Locks for in-swing doors are standard. For out-swing doors, please specify.

*Unlacquered Brass (US3NL) finish available for a \$25 List Price upcharge per item.

To order: **Function + Product Code + Backset + Knob/Lever Style + Handing + Finish + Add Door Thickness to Comments**

Manhattan Mortise
ANSI F20



Charleston Mortise
ANSI F20



Harrison Mortise
ANSI F13



Interior trim view

ANSI F20
Function

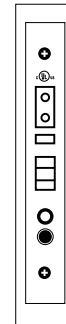

ANSI F13
Function



MANHATTAN MORTISE		Product Code	Backset	Knob or Lever Style	Handing	Finish	List Price
Entry Set	Specify F20 or F13 Function	3506	2 1/2" or 2 3/4"	See Pages 10-23 for Brass Knob & Lever Options.	LH/RH	Polished Brass - Lifetime (US3) French Antique (US7) Oil Rubbed Bronze (US10B) Polished Nickel - Lifetime (US14) Satin Nickel (US15) Pewter (US15A) Flat Black (US19) Polished Chrome (US26) Unlacquered Brass (US3NL)*	\$868
Dummy	N/A	3106	N/A				\$557
CHARLESTON MORTISE		Product Code	Backset				List Price
Entry Set	Specify F20 or F13 Function	3543	2 1/2" or 2 3/4"				\$868
Dummy	N/A	3143	N/A				\$557
HARRISON MORTISE		Product Code	Backset				List Price
Entry Set	Specify F20 or F13 Function	3551	2 1/2" or 2 3/4"	\$868			
Dummy	N/A	3151	N/A	\$557			

- Handing is Required for ALL Mortise Locks
- Standard door thickness of 1 3/4". Specify if thicker.
- Locks for in-swing doors are standard. For out-swing doors, please specify.

*Unlacquered Brass (US3NL) finish available for a \$25 List Price upcharge per item.

**Memphis Mortise
ANSI F20**



**Regency Mortise
ANSI F20**



**Craftsman Mortise
ANSI F13**



Interior trim view

**ANSI F20
Function**

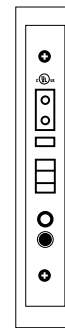

**ANSI F13
Function**

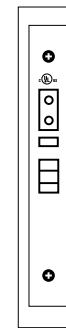

MEMPHIS MORTISE		Product Code	Backset	Knob or Lever Style	Handing	Finish	List Price
Entry Set	Specify F20 or F13 Function	3502	2 1/2" or 2 3/4"	See Pages 10-23 for Brass Knob & Lever Options.	LH/RH	Polished Brass - Lifetime (US3) French Antique (US7) Oil Rubbed Bronze (US10B) Polished Nickel - Lifetime (US14) Satin Nickel (US15) Pewter (US15A) Polished Chrome (US26) Unlacquered Brass (US3NL)*	\$868
Dummy	N/A	3102	N/A			Polished Brass - Lifetime (US3) French Antique (US7) Oil Rubbed Bronze (US10B) Satin Nickel (US15) Pewter (US15A) Polished Chrome (US26) Unlacquered Brass (US3NL)*	\$557
REGENCY MORTISE		Product Code	Backset				List Price
Entry Set	Specify F20 or F13 Function	3507	2 1/2" or 2 3/4"			Polished Brass - Lifetime (US3) French Antique (US7) Oil Rubbed Bronze (US10B) Satin Nickel (US15) Pewter (US15A) Polished Chrome (US26) Unlacquered Brass (US3NL)*	\$868
Dummy	N/A	3107	N/A			Polished Brass - Lifetime (US3) French Antique (US7) Oil Rubbed Bronze (US10B) Satin Nickel (US15) Pewter (US15A) Polished Chrome (US26) Unlacquered Brass (US3NL)*	\$557
CRAFTSMAN MORTISE		Product Code	Backset	Knob or Lever Style	Handing	Finish	List Price
Entry Set	Specify F20 or F13 Function	3508	2 1/2" or 2 3/4"	See Pages 10-23 for Brass Knob & Lever Options.	LH/RH	Oil Rubbed Bronze (US10B) Satin Nickel (US15) Flat Black (US19) Unlacquered Brass (US3NL)*	\$868
Dummy	N/A	3108	N/A			Oil Rubbed Bronze (US10B) Satin Nickel (US15) Flat Black (US19) Unlacquered Brass (US3NL)*	\$557

- **Handing is Required for ALL Mortise Locks**
- Standard door thickness of 1 3/4". Specify if thicker.
- Locks for in-swing doors are standard. For out-swing doors, please specify.

*Unlacquered Brass (US3NL) finish available for a \$25 List Price upcharge per item.

To order: **Function + Product Code + Backset + Knob/Lever Style + Handing + Finish** + Add Door Thickness to Comments

Rectangular Mortise
ANSI F20



Cheyenne Mortise
ANSI F20



Hailey Mortise
ANSI F13



Interior Trim View

ANSI F20
Function



ANSI F13
Function

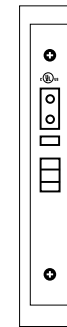

RECTANGULAR MORTISE		Product Code	Backset	Knob or Lever Style	Handing	Finish	List Price	
Entry Set	Specify F20 or F13 Function	3525	2 1/2" or 2 3/4"	See Pages 24-25 for Sandcast Bronze Knob & Lever Options.	LH/RH	Flat Black Bronze (FB) Medium Bronze (MB) Tumbled White Bronze (TWB)	\$973	
Dummy	N/A	3125	N/A				See Pages 22-23 for Glass & Porcelain Knob Options.	\$658
CHEYENNE MORTISE		Product Code	Backset					List Price
Entry Set	Specify F20 or F13 Function	3521	2 1/2" or 2 3/4"	See Pages 24-25 for Sandcast Bronze Knob & Lever Options.	LH/RH	Flat Black Bronze (FB) Medium Bronze (MB) Tumbled White Bronze (TWB)	\$973	
Dummy	N/A	3121	N/A				\$658	
HAILEY MORTISE		Product Code	Backset					List Price
Entry Set	Specify F20 or F13 Function	3534	2 1/2" or 2 3/4"	See Pages 24-25 for Sandcast Bronze Knob & Lever Options.	LH/RH	Flat Black Bronze (FB) Medium Bronze (MB) Tumbled White Bronze (TWB)	\$973	
Dummy	N/A	3134	N/A				\$658	

- Handing is Required for ALL Mortise Locks
- Standard door thickness of 1 3/4". Specify if thicker.
- Locks for in-swing doors are standard. For out-swing doors, please specify.

Da Vinci Mortise
ANSI F20



Octagon Mortise
ANSI F20



Mormont
Stainless Steel Mortise
ANSI F13



Interior Trim View

ANSI F20
Function

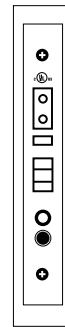

ANSI F13
Function

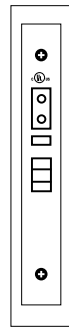

DA VINCI MORTISE		Product Code	Backset	Knob or Lever Style	Handing	Finish	List Price
Entry Set	Specify F20 or F13 Function	3531	2 1/2" or 2 3/4"	See Pages 24-25 for Tuscan Bronze Knob & Lever Options.	LH/RH	Flat Black Bronze (FB) Medium Bronze (MB)	\$973
Dummy	N/A	3131	N/A				See Pages 22-23 for Glass & Porcelain Knob Options.
OCTAGON MORTISE		Product Code	Backset				List Price
Entry Set	Specify F20 or F13 Function	3533	2 1/2" or 2 3/4"				\$973
Dummy	N/A	3133	N/A				\$658
MORMONT STAINLESS STEEL MORTISE		Product Code	Backset	Knob or Lever Style	Handing	Finish	List Price
Entry Set	Specify F20 or F13 Function	S3501	2 1/2" or 2 3/4"	See Pages 26-27 for Stainless Steel Knob & Lever Options.	LH/RH	Brushed Stainless Steel (SS)	\$868
Dummy	N/A	S3101	N/A				\$557

- Handing is Required for ALL Mortise Locks
- Standard door thickness of 1 3/4". Specify if thicker.
- Locks for in-swing doors are standard. For out-swing doors, please specify.

To order: **Function + Product Code + Backset + Knob/Lever Style + Handing + Finish + Add Door Thickness to Comments**

Hercules Smooth Sectional



Hercules Smooth Monolithic

5½" Center-to-Center Door Prep



Hercules Smooth Full Length

5½" Center-to-Center Door Prep



EMPowered™ 2 Smart Lock Upgrade with Wi-Fi

Includes Yale Access Module, Wi-Fi Bridge and DoorSense™. For use in the US and Canada only, see pages 28-33 for details.



Inside trim is pre-configured with Square Rosette

HERCULES SMOOTH SECTIONAL	EMPowered Upgrade	Product Code	Knob or Lever Style for Inside Trim	Finish**	List Price	EMPowered Upgrade List Price
Single Cylinder	EMP2	4214	See Pages 10-23 for Brass Knob & Lever Options.	Satin Brass (US4) French Antique (US7) Oil Rubbed Bronze (US10B) Polished Nickel - Lifetime (US14) Satin Nickel (US15) Flat Black (US19) Polished Chrome (US26) Unlacquered Brass (US3NL)*	\$441	\$826
Double Cylinder		4224			\$441	
Dummy		4204			\$441	
HERCULES SMOOTH MONOLITHIC	EMPowered Upgrade	Product Code			List Price	EMPowered Upgrade List Price
Single Cylinder	EMP2	4215	\$507		\$892	
Double Cylinder		4225	\$507			
Dummy		4205	\$507			
HERCULES SMOOTH FULL LENGTH	EMPowered Upgrade	Product Code	List Price		EMPowered Upgrade List Price	
Single Cylinder	EMP2	4216	\$594		\$979	
Double Cylinder		4226	\$594			
Dummy		4206	\$594			
INTERCONNECT DEVICE	Product Code	List Price				
Hercules Smooth Monolithic and Full Length	443	Not Available for Double Cylinder or EMPowered™ Upgrade. Handing Required.	\$98			

*Unlacquered Brass (US3NL) finish available for a \$25 List Price upcharge per item.

**EMPowered™ 2 Finishes: Satin Brass (US4), Oil Rubbed Bronze (US10B), Polished Nickel - Lifetime (US14), Satin Nickel (US15), Flat Black (US19), Polished Chrome (US26) and Unlacquered Brass (US3NL).

- **Handing Required if Lever Used on Inside or if Interconnect Device is Specified**
- Fits standard door thickness of 1¾". Specify if thicker. EMPowered™ 2 fits door thickness up to 2¼".
- Standard 2½" door prep. Standard latch is for 2¾" backset. Specify 2¾" backset if required.
- Latches come standard with square corner strike and face plates. Specify radius corners if required.
- 28° rotation latch not available for use with Tubular Entrance Handlesets.

Weiser® (WR5) Keyway

- Specify by adding "W" to the beginning of product code.
- No upcharge for cylinder substitution.
- Can be keyed into existing Weiser® system.

Hercules Knurled Sectional



Hercules Knurled Monolithic

5½" Center-to-Center Door Prep



Hercules Knurled Full Length

5½" Center-to-Center Door Prep



EMPowered™ 2 Smart Lock Upgrade with Wi-Fi

Includes Yale Access Module, Wi-Fi Bridge and DoorSense™. For use in the US and Canada only, see pages 28-33 for details.



Inside trim is pre-configured with Square Rosette

HERCULES KNURLED SECTIONAL	EMPowered Upgrade	Product Code	Knob or Lever Style for Inside Trim	Finish**	List Price	EMPowered Upgrade List Price
Single Cylinder	EMP2	4217	See Pages 10-23 for Brass Knob & Lever Options.	Satin Brass (US4) French Antique (US7) Oil Rubbed Bronze (US10B) Polished Nickel - Lifetime (US14) Satin Nickel (US15) Flat Black (US19) Polished Chrome (US26) Unlacquered Brass (US3NL)*	\$441	\$826
Double Cylinder		4227			\$441	
Dummy		4207			\$441	
HERCULES KNURLED MONOLITHIC	EMPowered Upgrade	Product Code			List Price	EMPowered Upgrade List Price
Single Cylinder	EMP2	4218			\$507	\$892
Double Cylinder		4228			\$507	
Dummy		4208	\$507			
HERCULES KNURLED FULL LENGTH	EMPowered Upgrade	Product Code	List Price	EMPowered Upgrade List Price		
Single Cylinder	EMP2	4219	\$594	\$979		
Double Cylinder		4229	\$594			
Dummy		4209	\$594			
INTERCONNECT DEVICE		Product Code		List Price		
Hercules Knurled Monolithic and Full Length		443	Not Available for Double Cylinder or EMPowered™ Upgrade. Handing Required.	\$98		

*Unlacquered Brass (US3NL) finish available for a \$25 List Price upcharge per item.

**EMPowered™ 2 Finishes: Satin Brass (US4), Oil Rubbed Bronze (US10B), Polished Nickel - Lifetime (US14), Satin Nickel (US15), Flat Black (US19), Polished Chrome (US26) and Unlacquered Brass (US3NL).

- **Handing Required if Lever Used on Inside or if Interconnect Device is Specified**
- Fits standard door thickness of 1¾". Specify if thicker. EMPowered™ 2 fits door thickness up to 2¼".
- Standard 2½" door prep. Standard latch is for 2¾" backset. Specify 2¾" backset if required.
- Latches come standard with square corner strike and face plates. Specify radius corners if required.
- 28° rotation latch not available for use with Tubular Entrance Handlesets.

Weiser® (WR5) Keyway

- Specify by adding "W" to the beginning of product code.
- No upcharge for cylinder substitution.
- Can be keyed into existing Weiser® system.

To order: **(W) Function + Product Code + Knob/Lever Style + Handing + Finish + Add Door Thickness to Comments**

Baden



Davos

5½" Center-to-Center Door Prep



Lausanne

5½" Center-to-Center Door Prep



EMPowered™ 2 Smart Lock Upgrade with Wi-Fi

Includes Yale Access Module, Wi-Fi Bridge and DoorSense™. For use in the US and Canada only, see pages 28-33 for details.



Inside trim is pre-configured with Square Rosette

BADEN	EMPowered Upgrade	Product Code	Knob or Lever Style for Inside Trim	Finish**	List Price	EMPowered Upgrade List Price
Single Cylinder	EMP2	4820	See Pages 10-23 for Brass Knob & Lever Options.	Satin Brass (US4) French Antique (US7) Oil Rubbed Bronze (US10B) Polished Nickel - Lifetime (US14) Satin Nickel (US15) Flat Black (US19) Polished Chrome (US26) Unlacquered Brass (US3NL)*	\$441	\$826
Double Cylinder		4830			\$441	
Dummy		4810			\$441	
DAVOS	EMPowered Upgrade	Product Code			List Price	EMPowered Upgrade List Price
Single Cylinder	EMP2	4818			\$507	\$892
Double Cylinder		4828			\$507	
Dummy		4808	\$507			
LAUSANNE	EMPowered Upgrade	Product Code	List Price	EMPowered Upgrade List Price		
Single Cylinder	EMP2	4819	\$594	\$979		
Double Cylinder		4829	\$594			
Dummy		4809	\$594			
INTERCONNECT DEVICE		Product Code			List Price	
Davos & Lausanne Styles		443	Not Available for Double Cylinder or EMPowered™ Upgrade. Hanging Required.		\$98	

*Unlacquered Brass (US3NL) finish available for a \$25 List Price upcharge per item.

**EMPowered™ 2 Finishes: Satin Brass (US4), Oil Rubbed Bronze (US10B), Polished Nickel - Lifetime (US14), Satin Nickel (US15), Flat Black (US19), Polished Chrome (US26) and Unlacquered Brass (US3NL).

- **Hanging Required if Lever Used on Inside or if Interconnect Device is Specified**
- Fits standard door thickness of 1¾". Specify if thicker. EMPowered™ 2 fits door thickness up to 2¼".
- Standard 2½" door prep. Standard latch is for 2¾" backset. Specify 2¾" backset if required.
- Latches come standard with square corner strike and face plates. Specify radius corners if required.
- 28° rotation latch not available for use with Tubular Entrance Handlesets.

Weiser® (WR5) Keyway

- Specify by adding "W" to the beginning of product code.
- No upcharge for cylinder substitution.
- Can be keyed into existing Weiser® system.



**EMPowered™ 2
Smart Lock Upgrade
with Wi-Fi**

Includes Yale Access Module, Wi-Fi Bridge and DoorSense™. For use in the US and Canada only, see pages 28-33 for details.



Inside trim is pre-configured with Neos Rosette

ARES	EMPowered Upgrade	Product Code	Knob or Lever Style for Inside Trim	Finish**	List Price	EMPowered Upgrade List Price
Single Cylinder	EMP2	4817	See Pages 10-23 for Brass Knob & Lever Options.	Satin Brass (US4) Oil Rubbed Bronze (US10B) Polished Nickel - Lifetime (US14) Satin Nickel (US15) Flat Black (US19) Polished Chrome (US26) Unlacquered Brass (US3NL)*	\$441	\$826
Double Cylinder		4827			\$441	
Dummy		4807			\$441	
APOLLO	EMPowered Upgrade	Product Code			List Price	EMPowered Upgrade List Price
Single Cylinder	EMP2	4815			\$507	\$892
Double Cylinder		4825			\$507	
Dummy		4805	\$507			
ORION	EMPowered Upgrade	Product Code	List Price	EMPowered Upgrade List Price		
Single Cylinder	EMP2	4816	\$594	\$979		
Double Cylinder		4826	\$594			
Dummy		4806	\$594			
INTERCONNECT DEVICE		Product Code		List Price		
Apollo & Orion Styles	443	Not Available for Double Cylinder or EMPowered™ Upgrade. Handing Required.	\$98			

*Unlacquered Brass (US3NL) finish available for a \$25 List Price upcharge per item.

**EMPowered™ 2 Finishes: Satin Brass (US4), Oil Rubbed Bronze (US10B), Polished Nickel - Lifetime (US14), Satin Nickel (US15), Flat Black (US19), Polished Chrome (US26) and Unlacquered Brass (US3NL).

- **Handing Required if Lever Used on Inside or if Interconnect Device is Specified**
- Fits standard door thickness of 1¾". Specify if thicker. EMPowered™ 2 fits door thickness up to 2¼".
- Standard 2¼" door prep. Standard latch is for 2¾" backset. Specify 2¾" backset if required.
- Latches come standard with square corner strike and face plates. Specify radius corners if required.
- 28° rotation latch not available for use with Tubular Entrance Handlesets.

Weiser® (WR5) Keyway

- Specify by adding "W" to the beginning of product code.
- No upcharge for cylinder substitution.
- Can be keyed into existing Weiser® system.

To order: **(W) Function + Product Code + Knob/Lever Style + Handing + Finish + Add Door Thickness to Comments**

Urban Modern Sectional

EMPowered™ 2 Smart Lock Upgrade with Wi-Fi

Includes Yale Access Module, Wi-Fi Bridge and DoorSense™. For use in the US and Canada only, see pages 28-33 for details.



Inside trim is pre-configured with Urban Modern Rosette

Transitional Heritage Sectional

Transitional Heritage Monolithic

5½" Center-to-Center Door Prep



EMPowered™ 2 Smart Lock Upgrade with Wi-Fi

Includes Yale Access Module, Wi-Fi Bridge and DoorSense™. For use in the US and Canada only, see pages 28-33 for details.



Inside trim is pre-configured with Quincy Rosette

URBAN MODERN SECTIONAL	EMPowered Upgrade	Product Code	Knob or Lever Style for Inside Trim	Finish**	List Price	EMPowered Upgrade List Price
Single Cylinder	EMP2	4715	See Pages 10-23 for Brass Knob & Lever Options.	Satin Brass (US4) Oil Rubbed Bronze (US10B) Polished Nickel - Lifetime (US14) Satin Nickel (US15) Flat Black (US19) Polished Chrome (US26) Unlacquered Brass (US3NL)*	\$441	\$826
Double Cylinder		4725			\$441	
Dummy		4705			\$441	
TRANSITIONAL HERITAGE SECTIONAL	EMPowered Upgrade	Product Code			List Price	EMPowered Upgrade List Price
Single Cylinder	EMP2	4716			\$441	\$826
Double Cylinder		4726			\$441	
Dummy		4706	\$441			
TRANSITIONAL HERITAGE MONOLITHIC	EMPowered Upgrade	Product Code	List Price	EMPowered Upgrade List Price		
Single Cylinder	EMP2	4717	\$507	\$892		
Double Cylinder		4727	\$507			
Dummy		4707	\$507			
INTERCONNECT DEVICE		Product Code		List Price		
Transitional Heritage Monolithic Style		443	Not Available for Double Cylinder or EMPowered™ Upgrade. Handing Required.	\$98		

*Unlacquered Brass (US3NL) finish available for a \$25 List Price upcharge per item.

**EMPowered™ 2 Finishes: Satin Brass (US4), Oil Rubbed Bronze (US10B), Polished Nickel - Lifetime (US14), Satin Nickel (US15), Flat Black (US19), Polished Chrome (US26) and Unlacquered Brass (US3NL).

- **Handing Required if Lever Used on Inside or if Interconnect Device is Specified**
- Fits standard door thickness of 1¾". Specify if thicker. EMPowered™ 2 fits door thickness up to 2¼".
- Standard 2½" door prep. Standard latch is for 2¾" backset. Specify 2¾" backset if required.
- Latches come standard with square corner strike and face plates. Specify radius corners if required.
- 28° rotation latch not available for use with Tubular Entrance Handlesets.

Weiser® (WR5) Keyway

- Specify by adding "W" to the beginning of product code.
- No upcharge for cylinder substitution.
- Can be keyed into existing Weiser® system.

Franklin



Adams

5½" Center-to-Center Door Prep



Jefferson

5½" Center-to-Center Door Prep



EMPowered™ 2 Smart Lock Upgrade with Wi-Fi

Includes Yale Access Module, Wi-Fi Bridge and DoorSense™. For use in the US and Canada only, see pages 28-33 for details.



Inside trim is pre-configured with Quincy Rosette

FRANKLIN	EMPowered Upgrade	Product Code	Knob or Lever Style for Inside Trim	Finish**	List Price	EMPowered Upgrade List Price
Single Cylinder	EMP2	4413	See Pages 10-23 for Brass Knob & Lever Options.	Polished Brass - Lifetime (US3) Satin Brass (US4) French Antique (US7) Oil Rubbed Bronze (US10B) Polished Nickel - Lifetime (US14) Satin Nickel (US15) Pewter (US15A) Flat Black (US19) Polished Chrome (US26) Unlacquered Brass (US3NL)*	\$441	\$826
Double Cylinder		4423			\$441	
Dummy		4403			\$441	
ADAMS	EMPowered Upgrade	Product Code			List Price	EMPowered Upgrade List Price
Single Cylinder	EMP2	4414			\$507	\$892
Double Cylinder		4424			\$507	
Dummy		4404	\$507			
JEFFERSON	EMPowered Upgrade	Product Code	List Price	EMPowered Upgrade List Price		
Single Cylinder	EMP2	4415	\$594	\$979		
Double Cylinder		4425	\$594			
Dummy		4405	\$594			
INTERCONNECT DEVICE		Product Code		List Price		
Adams & Jefferson Styles		443	Not Available for Double Cylinder or EMPowered™ Upgrade. Handing Required.	\$98		

*Unlacquered Brass (US3NL) finish available for a \$25 List Price upcharge per item.

**EMPowered™ 2 Finishes: Satin Brass (US4), Oil Rubbed Bronze (US10B), Polished Nickel - Lifetime (US14), Satin Nickel (US15), Flat Black (US19), Polished Chrome (US26) and Unlacquered Brass (US3NL).

- **Handing Required if Lever Used on Inside or if Interconnect Device is Specified**
- Fits standard door thickness of 1¾". Specify if thicker. EMPowered™ 2 fits door thickness up to 2¼".
- Standard 2¼" door prep. Standard latch is for 2¾" backset. Specify 2¾" backset if required.
- Latches come standard with square corner strike and face plates. Specify radius corners if required.
- 28° rotation latch not available for use with Tubular Entrance Handlesets.

Weiser® (WR5) Keyway

- Specify by adding "W" to the beginning of product code.
- No upcharge for cylinder substitution.
- Can be keyed into existing Weiser® system.

To order: **(W) Function + Product Code + Knob/Lever Style + Handing + Finish + Add Door Thickness to Comments**

Hamden



Wilshire

5½" Center-to-Center Door Prep



Melrose

5½" Center-to-Center Door Prep



EMPowered™ 2 Smart Lock Upgrade with Wi-Fi

Includes Yale Access Module, Wi-Fi Bridge and DoorSense™. For use in the US and Canada only, see pages 28-33 for details.



Inside trim is pre-configured with Wilshire Rosette

HAMDEN	EMPowered Upgrade	Product Code	Knob or Lever Style for Inside Trim	Finish**	List Price	EMPowered Upgrade List Price
Single Cylinder	EMP2	4213	See Pages 10-23 for Brass Knob & Lever Options.	Polished Brass - Lifetime (US3) Satin Brass (US4) French Antique (US7) Oil Rubbed Bronze (US10B) Polished Nickel - Lifetime (US14) Satin Nickel (US15) Pewter (US15A) Flat Black (US19) Polished Chrome (US26) Unlacquered Brass (US3NL)*	\$441	\$826
Double Cylinder		4223			\$441	
Dummy		4203			\$441	
WILSHIRE	EMPowered Upgrade	Product Code			List Price	EMPowered Upgrade List Price
Single Cylinder	EMP2	4211			\$507	\$892
Double Cylinder		4221			\$507	
Dummy		4201	\$507			
MELROSE	EMPowered Upgrade	Product Code	List Price	EMPowered Upgrade List Price		
Single Cylinder	EMP2	4212	\$594	\$979		
Double Cylinder		4222	\$594			
Dummy		4202	\$594			
INTERCONNECT DEVICE		Product Code		List Price		
Wilshire & Melrose Styles		443	Not Available for Double Cylinder or EMPowered™ Upgrade. Handing Required.	\$98		

*Unlacquered Brass (US3NL) finish available for a \$25 List Price upcharge per item.

**EMPowered™ 2 Finishes: Satin Brass (US4), Oil Rubbed Bronze (US10B), Polished Nickel - Lifetime (US14), Satin Nickel (US15), Flat Black (US19), Polished Chrome (US26) and Unlacquered Brass (US3NL).

- **Handing Required if Lever Used on Inside or if Interconnect Device is Specified**
- Fits standard door thickness of 1¾". Specify if thicker. EMPowered™ 2 fits door thickness up to 2¼".
- Standard 2½" door prep. Standard latch is for 2¾" backset. Specify 2¾" backset if required.
- Latches come standard with square corner strike and face plates. Specify radius corners if required.
- 28° rotation latch not available for use with Tubular Entrance Handlesets.

Weiser® (WR5) Keyway

- Specify by adding "W" to the beginning of product code.
- No upcharge for cylinder substitution.
- Can be keyed into existing Weiser® system.

Nashville



Richmond

5½" Center-to-Center Door Prep



Wilmington

5½" Center-to-Center Door Prep



EMPowered™ 2 Smart Lock Upgrade with Wi-Fi

Includes Yale Access Module, Wi-Fi Bridge and DoorSense™. For use in the US and Canada only, see pages 28-33 for details.



Inside trim is pre-configured with #8 Rosette

NASHVILLE	EMPowered Upgrade	Product Code	Knob or Lever Style for Inside Trim	Finish**	List Price	EMPowered Upgrade List Price		
Single Cylinder	EMP2	4312	See Pages 10-23 for Brass Knob & Lever Options.	Polished Brass - Lifetime (US3) Satin Brass (US4) French Antique (US7) Oil Rubbed Bronze (US10B) Polished Nickel - Lifetime (US14) Satin Nickel (US15) Pewter (US15A) Flat Black (US19) Polished Chrome (US26) Unlacquered Brass (US3NL)*	\$441	\$826		
Double Cylinder		4322			\$441			
Dummy		4302			\$441			
RICHMOND	EMPowered Upgrade	Product Code					List Price	EMPowered Upgrade List Price
Single Cylinder	EMP2	4313					\$507	\$892
Double Cylinder		4323					\$507	
Dummy		4303					\$507	
WILMINGTON	EMPowered Upgrade	Product Code					List Price	EMPowered Upgrade List Price
Single Cylinder	EMP2	4314					\$594	\$979
Double Cylinder		4324			\$594			
Dummy		4304			\$594			
INTERCONNECT DEVICE		Product Code				List Price		
Richmond & Wilmington Styles		443	Not Available for Double Cylinder or EMPowered™ Upgrade. Handing Required.			\$98		

*Unlacquered Brass (US3NL) finish available for a \$25 List Price upcharge per item.

**EMPowered™ 2 Finishes: Satin Brass (US4), Oil Rubbed Bronze (US10B), Polished Nickel - Lifetime (US14), Satin Nickel (US15), Flat Black (US19), Polished Chrome (US26) and Unlacquered Brass (US3NL).

- **Handing Required if Lever Used on Inside or if Interconnect Device is Specified**
- Fits standard door thickness of 1¾". Specify if thicker. EMPowered™ 2 fits door thickness up to 2¼".
- Standard 2¼" door prep. Standard latch is for 2¾" backset. Specify 2¾" backset if required.
- Latches come standard with square corner strike and face plates. Specify radius corners if required.
- 28° rotation latch not available for use with Tubular Entrance Handlesets.

Weiser® (WR5) Keyway

- Specify by adding "W" to the beginning of product code.
- No upcharge for cylinder substitution.
- Can be keyed into existing Weiser® system.

To order: **(W) Function + Product Code + Knob/Lever Style + Handing + Finish + Add Door Thickness to Comments**

ENTRANCE HANDLESETS - BRASS TUBULAR

Saratoga



Marietta

5½" Center-to-Center Door Prep



EMPowered™ 2
Smart Lock Upgrade
with Wi-Fi

Includes Yale Access Module, Wi-Fi Bridge and DoorSense™. For use in the US and Canada only, see pages 28-33 for details.



Inside trim is pre-configured with Regular Rosette

SARATOGA	EMPowered Upgrade	Product Code	Knob or Lever Style for Inside Trim	Finish**	List Price	EMPowered Upgrade List Price
Single Cylinder	EMP2	4410	See Pages 10-23 for Brass Knob & Lever Options.	Polished Brass - Lifetime (US3) Satin Brass (US4) French Antique (US7) Oil Rubbed Bronze (US10B) Polished Nickel - Lifetime (US14) Satin Nickel (US15) Pewter (US15A) Flat Black (US19) Polished Chrome (US26) Unlacquered Brass (US3NL)*	\$441	\$826
Double Cylinder		4420			\$441	
Dummy		4400			\$441	
MARIETTA	EMPowered Upgrade	Product Code			List Price	EMPowered Upgrade List Price
Single Cylinder	EMP2	4411			\$507	\$892
Double Cylinder		4421			\$507	
Dummy		4401	\$507			
INTERCONNECT DEVICE		Product Code			List Price	
Marietta Style		443	Not Available for Double Cylinder or EMPowered™ Upgrade. Handing Required.		\$98	

*Unlacquered Brass (US3NL) finish available for a \$25 List Price upcharge per item.

**EMPowered™ 2 Finishes: Satin Brass (US4), Oil Rubbed Bronze (US10B), Polished Nickel - Lifetime (US14), Satin Nickel (US15), Flat Black (US19), Polished Chrome (US26) and Unlacquered Brass (US3NL).

- **Handing Required if Lever Used on Inside or if Interconnect Device is Specified**
- Fits standard door thickness of 1¾". Specify if thicker. **EMPowered™ 2 fits door thickness up to 2¼"**.
- Standard 2½" door prep. Standard latch is for 2¾" backset. Specify 2¾" backset if required.
- Latches come standard with square corner strike and face plates. Specify radius corners if required.
- 28° rotation latch not available for use with Tubular Entrance Handlesets.

Weiser® (WR5) Keyway

- Specify by adding "W" to the beginning of product code.
- No upcharge for cylinder substitution.
- Can be keyed into existing Weiser® system.

Knoxville



Orleans

5½" Center-to-Center Door Prep



**EMPowered™ 2
Smart Lock Upgrade
with Wi-Fi**

Includes Yale Access Module, Wi-Fi Bridge and DoorSense™. For use in the US and Canada only, see pages 28-33 for details.



Inside trim is pre-configured with #8 Rosette

KNOXVILLE	EMPowered Upgrade	Product Code	Knob or Lever Style for Inside Trim	Finish**	List Price	EMPowered Upgrade List Price
Single Cylinder	EMP2	4310	See Pages 10-23 for Brass Knob & Lever Options.	Polished Brass - Lifetime (US3) French Antique (US7) Oil Rubbed Bronze (US10B) Satin Nickel (US15) Pewter (US15A) Polished Chrome (US26) Unlacquered Brass (US3NL)*	\$441	\$826
Double Cylinder		4320			\$441	
Dummy		4300			\$441	
ORLEANS	EMPowered Upgrade	Product Code			List Price	EMPowered Upgrade List Price
Single Cylinder	EMP2	4311			\$507	\$892
Double Cylinder		4321			\$507	
Dummy		4301	\$507			
INTERCONNECT DEVICE		Product Code		List Price		
Orleans Style		443	Not Available for Double Cylinder or EMPowered™ Upgrade. Hanging Required.	\$98		

*Unlacquered Brass (US3NL) finish available for a \$25 List Price upcharge per item.

**EMPowered™ 2 Finishes: Satin Brass (US4), Oil Rubbed Bronze (US10B), Polished Nickel - Lifetime (US14), Satin Nickel (US15), Flat Black (US19), Polished Chrome (US26) and Unlacquered Brass (US3NL).

- **Handing Required if Lever Used on Inside or if Interconnect Device is Specified**
- Fits standard door thickness of 1¾". Specify if thicker. EMPowered™ 2 fits door thickness up to 2¼".
- Standard 2½" door prep. Standard latch is for 2¾" backset. Specify 2¾" backset if required.
- Latches come standard with square corner strike and face plates. Specify radius corners if required.
- 28° rotation latch not available for use with Tubular Entrance Handlesets.

Weiser® (WR5) Keyway

- Specify by adding "W" to the beginning of product code.
- No upcharge for cylinder substitution.
- Can be keyed into existing Weiser® system.

To order: **(W) Function + Product Code + Knob/Lever Style + Handing + Finish + Add Door Thickness to Comments**

ENTRANCE HANDLESETS - BRASS TUBULAR

Ribbon & Reed

5½" Center-to-Center Door Prep



Imperial

5½" Center-to-Center Door Prep



EMPowered™ 2 Smart Lock Upgrade with Wi-Fi

Includes Yale Access Module, Wi-Fi Bridge and DoorSense™. For use in the US and Canada only, see pages 28-33 for details.



Inside trim is pre-configured with Ribbon & Reed Rosette

RIBBON & REED	EMPowered Upgrade	Product Code	Knob or Lever Style for Inside Trim	Finish**	List Price	EMPowered Upgrade List Price
Single Cylinder	EMP2	4711	See Pages 10-23 for Brass Knob & Lever Options.	Polished Brass - Lifetime (US3) French Antique (US7) Oil Rubbed Bronze (US10B) Satin Nickel (US15) Pewter (US15A) Polished Chrome (US26) Unlacquered Brass (US3NL)*	\$507	\$892
Double Cylinder		4721			\$507	
Dummy		4701			\$507	
IMPERIAL	EMPowered Upgrade	Product Code			List Price	EMPowered Upgrade List Price
Single Cylinder	EMP2	4911			\$594	\$979
Double Cylinder		4921			\$594	
Dummy		4901			\$594	
INTERCONNECT DEVICE		Product Code			List Price	
Available for Above Styles		443	Not Available for Double Cylinder or EMPowered™ Upgrade. Handing Required.		\$98	

*Unlacquered Brass (US3NL) finish available for a \$25 List Price upcharge per item.

**EMPowered™ 2 Finishes: Satin Brass (US4), Oil Rubbed Bronze (US10B), Polished Nickel - Lifetime (US14), Satin Nickel (US15), Flat Black (US19), Polished Chrome (US26) and Unlacquered Brass (US3NL).

- **Handing Required if Lever Used on Inside or if Interconnect Device is Specified**
- Fits standard door thickness of 1¾". Specify if thicker. **EMPowered™ 2 fits door thickness up to 2¼"**.
- Standard 2½" door prep. Standard latch is for 2¾" backset. Specify 2¾" backset if required.
- Latches come standard with square corner strike and face plates. Specify radius corners if required.
- 28° rotation latch not available for use with Tubular Entrance Handlesets.

Weiser® (WR5) Keyway

- Specify by adding "W" to the beginning of product code.
- No upcharge for cylinder substitution.
- Can be keyed into existing Weiser® system.

Arts & Crafts
5½" Center-to-Center Door Prep



Arts & Crafts Full Length
5½" Center-to-Center Door Prep



**EMPowered™ 2
Smart Lock Upgrade
with Wi-Fi**

Includes Yale Access Module, Wi-Fi Bridge and DoorSense™. For use in the US and Canada only, see pages 28-33 for details.



Inside trim is pre-configured with Arts & Crafts Rosette

ARTS & CRAFTS	EMPowered Upgrade	Product Code	Knob or Lever Style for Inside Trim	Finish**	List Price	EMPowered Upgrade List Price
Single Cylinder	EMP2	4811	See Pages 10-23 for Brass Knob & Lever Options.	Oil Rubbed Bronze (US10B) Satin Nickel (US15) Flat Black (US19) Unlacquered Brass (US3NL)*	\$507	\$892
Double Cylinder		4821			\$507	
Dummy		4801			\$507	
ARTS & CRAFTS FULL LENGTH	EMPowered Upgrade	Product Code			List Price	EMPowered Upgrade List Price
Single Cylinder	EMP2	4812			\$594	\$979
Double Cylinder		4822			\$594	
Dummy		4802			\$594	
INTERCONNECT DEVICE		Product Code				List Price
Available for Above Styles		443	Not Available for Double Cylinder or EMPowered™ Upgrade. Handing Required.			\$98

*Unlacquered Brass (US3NL) finish available for a \$25 List Price upcharge per item.

**EMPowered™ 2 Finishes: Satin Brass (US4), Oil Rubbed Bronze (US10B), Polished Nickel - Lifetime (US14), Satin Nickel (US15), Flat Black (US19), Polished Chrome (US26) and Unlacquered Brass (US3NL).

- **Handing Required if Lever Used on Inside or if Interconnect Device is Specified**
- Fits standard door thickness of 1¾". Specify if thicker. EMPowered™ 2 fits door thickness up to 2¼".
- Standard 2¼" door prep. Standard latch is for 2¾" backset. Specify 2¾" backset if required.
- Latches come standard with square corner strike and face plates. Specify radius corners if required.
- 28° rotation latch not available for use with Tubular Entrance Handlesets.

Weiser® (WR5) Keyway

- Specify by adding "W" to the beginning of product code.
- No upcharge for cylinder substitution.
- Can be keyed into existing Weiser® system.

To order: **(W) Function + Product Code + Knob/Lever Style + Handing + Finish + Add Door Thickness to Comments**

Rustic Modern Rectangular Sectional



Rustic Modern Rectangular Monolithic

5½" Center-to-Center Door Prep



Rustic Modern Rectangular Full Length

5½" Center-to-Center Door Prep



RUSTIC MODERN RECTANGULAR SECTIONAL		Product Code	Knob or Lever Style for Inside Trim	Finish	List Price
Single Cylinder		451421	See Pages 24-25 for Sandcast Bronze Knob & Lever Options. See Pages 22-23 for Glass & Porcelain Knob Options.	Flat Black Bronze (FB) Medium Bronze (MB) Tumbled White Bronze (TWB)	\$611
Double Cylinder		452421			\$611
Dummy		450421			\$611
RUSTIC MODERN RECTANGULAR MONOLITHIC		Product Code			List Price
Single Cylinder		451522			\$680
Double Cylinder		452522			\$680
Dummy		450522			\$680
RUSTIC MODERN RECTANGULAR FULL LENGTH		Product Code			List Price
Single Cylinder		451623			\$763
Double Cylinder		452623			\$763
Dummy		450623			\$763
INTERCONNECT DEVICE		Product Code			List Price
Rustic Modern Rectangular Monolithic & Full Length Styles		443	Not Available for Double Cylinder. Handing Required.		\$98

- **Handing Required if Lever Used on Inside or if Interconnect Device is Specified**
- Fits standard door thickness of 1¾". Specify if thicker.
- Standard 2½" door prep. Standard latch is for 2¾" backset. Specify 2¾" backset if required.
- Latches come standard with square corner strike and face plates. Specify radius corners if required.
- 28° rotation latch not available for use with Tubular Entrance Handlesets.

Weiser® (WR5) Keyway

- Specify by adding "W" to the beginning of product code.
- No upcharge for cylinder substitution.
- Can be keyed into existing Weiser® system.

Ridgemont



Logan

5½" Center-to-Center Door Prep



Brighton

5½" Center-to-Center Door Prep



RIDGEMONT	Product Code	Knob or Lever Style for Inside Trim	Finish	List Price
Single Cylinder	451721	See Pages 24-25 for Sandcast Bronze Knob & Lever Options. See Pages 22-23 for Glass & Porcelain Knob Options.	Flat Black Bronze (FB) Medium Bronze (MB) Tumbled White Bronze (TWB)	\$611
Double Cylinder	452721			\$611
Dummy	450721			\$611
LOGAN	Product Code			List Price
Single Cylinder	451822			\$680
Double Cylinder	452822			\$680
Dummy	450822	\$680		
BRIGHTON	Product Code	List Price		
Single Cylinder	451923	\$763		
Double Cylinder	452923	\$763		
Dummy	450923	\$763		
INTERCONNECT DEVICE	Product Code	List Price		
Logan & Brighton Styles	443	Not Available for Double Cylinder. Handing Required.	\$98	

- **Handing Required if Lever Used on Inside or if Interconnect Device is Specified**
- Fits standard door thickness of 1¾". Specify if thicker.
- Standard 2½" door prep. Standard latch is for 2¾" backset. Specify 2¾" backset if required.
- Latches come standard with square corner strike and face plates. Specify radius corners if required.
- 28° rotation latch not available for use with Tubular Entrance Handlesets.

Weiser® (WR5) Keyway

- Specify by adding "W" to the beginning of product code.
- No upcharge for cylinder substitution.
- Can be keyed into existing Weiser® system.

To order: **(W) Function + Product Code + Knob/Lever Style + Handing + Finish + Add Door Thickness to Comments**

Rectangular Sectional



Rectangular Monolithic

5½" Center-to-Center Door Prep



Rectangular Full Length

5½" Center-to-Center Door Prep



RECTANGULAR SECTIONAL	Product Code	Knob or Lever Style for Inside Trim	Finish	List Price	
Single Cylinder	451411	See Pages 24-25 for Sandcast Bronze Knob & Lever Options. See Pages 22-23 for Glass & Porcelain Knob Options.	Flat Black Bronze (FB) Medium Bronze (MB) Tumbled White Bronze (TWB)	\$611	
Double Cylinder	452411			\$611	
Dummy	450411			\$611	
RECTANGULAR MONOLITHIC	Product Code				List Price
Single Cylinder	451512				\$680
Double Cylinder	452512				\$680
Dummy	450512				\$680
RECTANGULAR FULL LENGTH	Product Code				List Price
Single Cylinder	451613				\$763
Double Cylinder	452613			\$763	
Dummy	450613			\$763	
INTERCONNECT DEVICE	Product Code			List Price	
Rectangular Monolithic & Full Length Styles	443	Not Available for Double Cylinder. Handing Required.		\$98	

- **Handing Required if Lever Used on Inside or if Interconnect Device is Specified**
- Fits standard door thickness of 1¾". Specify if thicker.
- Standard 2½" door prep. Standard latch is for 2¾" backset. Specify 2¾" backset if required.
- Latches come standard with square corner strike and face plates. Specify radius corners if required.
- 28° rotation latch not available for use with Tubular Entrance Handlesets.

Weiser® (WR5) Keyway

- Specify by adding "W" to the beginning of product code.
- No upcharge for cylinder substitution.
- Can be keyed into existing Weiser® system.

Denver



Remington

5½" Center-to-Center Door Prep



Greeley

5½" Center-to-Center Door Prep



DENVER	Product Code	Knob or Lever Style for Inside Trim	Finish	List Price
Single Cylinder	451211	See Pages 24-25 for Sandcast Bronze Knob & Lever Options. See Pages 22-23 for Glass & Porcelain Knob Options.	Flat Black Bronze (FB) Medium Bronze (MB) Tumbled White Bronze (TWB)	\$611
Double Cylinder	452211			\$611
Dummy	450211			\$611
REMINGTON	Product Code			List Price
Single Cylinder	451112			\$680
Double Cylinder	452112			\$680
Dummy	450112		\$680	
GREELEY	Product Code		List Price	
Single Cylinder	451332		\$763	
Double Cylinder	452332		\$763	
Dummy	450332		\$763	
INTERCONNECT DEVICE	Product Code		List Price	
Remington & Greeley Styles	443	Not Available for Double Cylinder. Handing Required.	\$98	

- **Handing Required if Lever Used on Inside or if Interconnect Device is Specified**
- Fits standard door thickness of 1¾". Specify if thicker.
- Standard 2¼" door prep. Standard latch is for 2¾" backset. Specify 2¾" backset if required.
- Latches come standard with square corner strike and face plates. Specify radius corners if required.
- 28° rotation latch not available for use with Tubular Entrance Handlesets.

Weiser® (WR5) Keyway

- Specify by adding "W" to the beginning of product code.
- No upcharge for cylinder substitution.
- Can be keyed into existing Weiser® system.

To order: **(W) Function + Product Code + Knob/Lever Style + Handing + Finish + Add Door Thickness to Comments**

ENTRANCE HANDLESETS - TUSCANY BRONZE TUBULAR

Tuscany Sectional



Tuscany Monolithic

5½" Center-to-Center Door Prep



TUSCANY SECTIONAL	Product Code	Knob or Lever Style for Inside Trim	Finish	List Price
Single Cylinder	471224	See Pages 24-25 for Tuscany Bronze Knob & Lever Options. See Pages 22-23 for Glass & Porcelain Knob Options.	Flat Black Bronze (FB) Medium Bronze (MB)	\$611
Double Cylinder	472224			\$611
Dummy	470224			\$611
TUSCANY MONOLITHIC	Product Code			List Price
Single Cylinder	471112			\$680
Double Cylinder	472112			\$680
Dummy	470112		\$680	
INTERCONNECT DEVICE	Product Code		List Price	
Tuscany Monolithic Style	443	Not Available for Double Cylinder. Handing Required.	\$98	

- **Handing Required if Lever Used on Inside or if Interconnect Device is Specified**
- Fits standard door thickness of 1¾". Specify if thicker.
- Standard 2½" door prep. Standard latch is for 2¾" backset. Specify 2¾" backset if required.
- Latches come standard with square corner strike and face plates. Specify radius corners if required.
- 28° rotation latch not available for use with Tubular Entrance Handlesets.

Weiser® (WR5) Keyway

- Specify by adding "W" to the beginning of product code.
- No upcharge for cylinder substitution.
- Can be keyed into existing Weiser® system.

Art Nouveau

5½" Center-to-Center Door Prep



Left Hand Grip Right Hand Grip

Octagon

5½" Center-to-Center Door Prep



ART NOUVEAU	Product Code	Specify LH/RH Grip	Knob or Lever Style for Inside Trim	Finish	List Price
Single Cylinder	471333		See Pages 24-25 for Tuscan Bronze Knob & Lever Options.	Flat Black Bronze (FB) Medium Bronze (MB)	\$680
Double Cylinder	472333		See Pages 22-23 for Glass & Porcelain Knob Options.		\$680
Dummy	470333				\$680

OCTAGON	Product Code	Knob or Lever Style for Inside Trim	Finish	List Price
Single Cylinder	471222	See Pages 24-25 for Tuscan Bronze Knob & Lever Options. See Pages 22-23 for Glass & Porcelain Knob Options.	Flat Black Bronze (FB) Medium Bronze (MB)	\$680
Double Cylinder	472222			\$680
Dummy	470222			\$680

INTERCONNECT DEVICE	Product Code		List Price
Available for Above Styles	443	Not Available for Double Cylinder. Handing Required.	\$98

- **Handing Required if Lever Used on Inside or if Interconnect Device is Specified**
- Fits standard door thickness of 1¾". Specify if thicker.
- Standard 2¼" door prep. Standard latch is for 2¾" backset. Specify 2¾" backset if required.
- Latches come standard with square corner strike and face plates. Specify radius corners if required.
- 28° rotation latch not available for use with Tubular Entrance Handlesets.

Weiser® (WR5) Keyway

- Specify by adding "W" to the beginning of product code.
- No upcharge for cylinder substitution.
- Can be keyed into existing Weiser® system.

To order: **(W) Function + Product Code + Knob/Lever Style + Handing + Finish + Add Door Thickness to Comments**

ENTRANCE HANDLESETS - WROUGHT STEEL TUBULAR

Sectional
with Lafayette Grip



Sectional
with San Carlos Grip



Sectional
with Normandy Grip

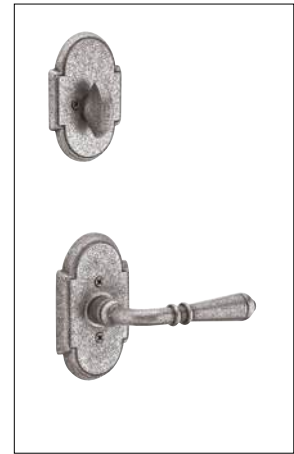

Order any wrought steel knob or lever for the inside trim.

SECTIONAL WITH LAFAYETTE GRIP	Product Code	Knob or Lever Style for Inside Trim See Pages 26-27 for Wrought Steel Knob & Lever Options.	Finish Flat Black Steel (FBS) Satin Steel (SWS)	List Price		
Single Cylinder	461212					\$441
Double Cylinder	462212					\$441
Dummy	460212					\$441
SECTIONAL WITH SAN CARLOS GRIP	Product Code			List Price		
Single Cylinder	461222			\$441		
Double Cylinder	462222			\$441		
Dummy	460222			\$441		
SECTIONAL WITH NORMANDY GRIP	Product Code			List Price		
Single Cylinder	461232			\$441		
Double Cylinder	462232			\$441		
Dummy	460232			\$441		

- **Handing Required if Lever Used on Inside**
- Fits standard door thickness of 1¾". Specify if thicker.
- Standard 2½" door prep. Standard latch is for 2¾" backset. Specify 2¾" backset if required.
- Latches come standard with square corner strike and face plates. Specify radius corners if required.
- 28° rotation latch not available for use with Tubular Entrance Handlesets.

Weiser® (WR5) Keyway

- Specify by adding "W" to the beginning of product code.
- No upcharge for cylinder substitution.
- Can be keyed into existing Weiser® system.

Monolithic
with Lafayette Grip
5½" Center-to-Center Door Prep



Monolithic
with San Carlos Grip
5½" Center-to-Center Door Prep



Monolithic
with Normandy Grip
5½" Center-to-Center Door Prep



Order any wrought steel knob or lever for the inside trim.

MONOLITHIC WITH LAFAYETTE GRIP	Product Code	Knob or Lever Style for Inside Trim	Finish	List Price		
Single Cylinder	461111	See Pages 26-27 for Wrought Steel Knob & Lever Options.	Flat Black Steel (FBS) Satin Steel (SWS)	\$507		
Double Cylinder	462111			\$507		
Dummy	460111			\$507		
MONOLITHIC WITH SAN CARLOS GRIP	Product Code					List Price
Single Cylinder	461121					\$507
Double Cylinder	462121					\$507
Dummy	460121					\$507
MONOLITHIC WITH NORMANDY GRIP	Product Code					List Price
Single Cylinder	461131					\$507
Double Cylinder	462131			\$507		
Dummy	460131			\$507		
INTERCONNECT DEVICE	Product Code			List Price		
Available for Above Styles	443	Not Available for Double Cylinder. Handing Required.		\$98		

- **Handing Required if Lever Used on Inside or if Interconnect Device is Specified**
- Fits standard door thickness of 1¾". Specify if thicker.
- Standard 2¼" door prep. Standard latch is for 2¾" backset. Specify 2¾" backset if required.
- Latches come standard with square corner strike and face plates. Specify radius corners if required.
- 28° rotation latch not available for use with Tubular Entrance Handlesets.

- Weiser® (WR5) Keyway**
- Specify by adding "W" to the beginning of product code.
 - No upcharge for cylinder substitution.
 - Can be keyed into existing Weiser® system.

To order: **(W) Function + Product Code + Knob/Lever Style + Handing + Finish + Add Door Thickness to Comments**

ENTRANCE HANDLESETS - STAINLESS STEEL TUBULAR

Davos Stainless Steel

5½" Center-to-Center Door Prep



DAVOS STAINLESS STEEL	Product Code	Knob or Lever Style for Inside Trim	Finish	List Price
Single Cylinder	S40101	See Pages 26-27 for Stainless Steel Knob & Lever Options.	Brushed Stainless Steel (SS)	\$507
Dummy	S40100			\$507

INTERCONNECT DEVICE	Product Code		List Price
Available for Davos Style	443	Not Available for Double Cylinder. Handing Required.	\$98

- **Handing Required if Lever Used on Inside or if Interconnect Device is Specified**
- Fits standard door thickness of 1¾". Specify if thicker.
- Standard 2½" door prep. Standard latch is for 2¾" backset. Specify 2¾" backset if required.
- Latches come standard with square corner strike and face plates. Specify radius corners if required.
- 28° rotation latch not available for use with Tubular Entrance Handlesets.

Weiser® (WR5) Keyway

- Specify by adding "W" to the beginning of product code.
- No upcharge for cylinder substitution.
- Can be keyed into existing Weiser® system.



INTERCONNECT DEVICE

Must be installed from the factory and cannot be ordered without a handleset.

This interconnect device allows for quick and convenient exit from your home in case of fire or other emergency. With this safety device installed, your deadbolt and latch will retract with the turn of the interior knob or lever, not requiring you to manually retract the deadbolt with the thumbturn.

- Adapter to convert select Brass Tubular handlesets into interconnected units.
- For use with Monolithic & Full Length, Single Cylinder handlesets only.

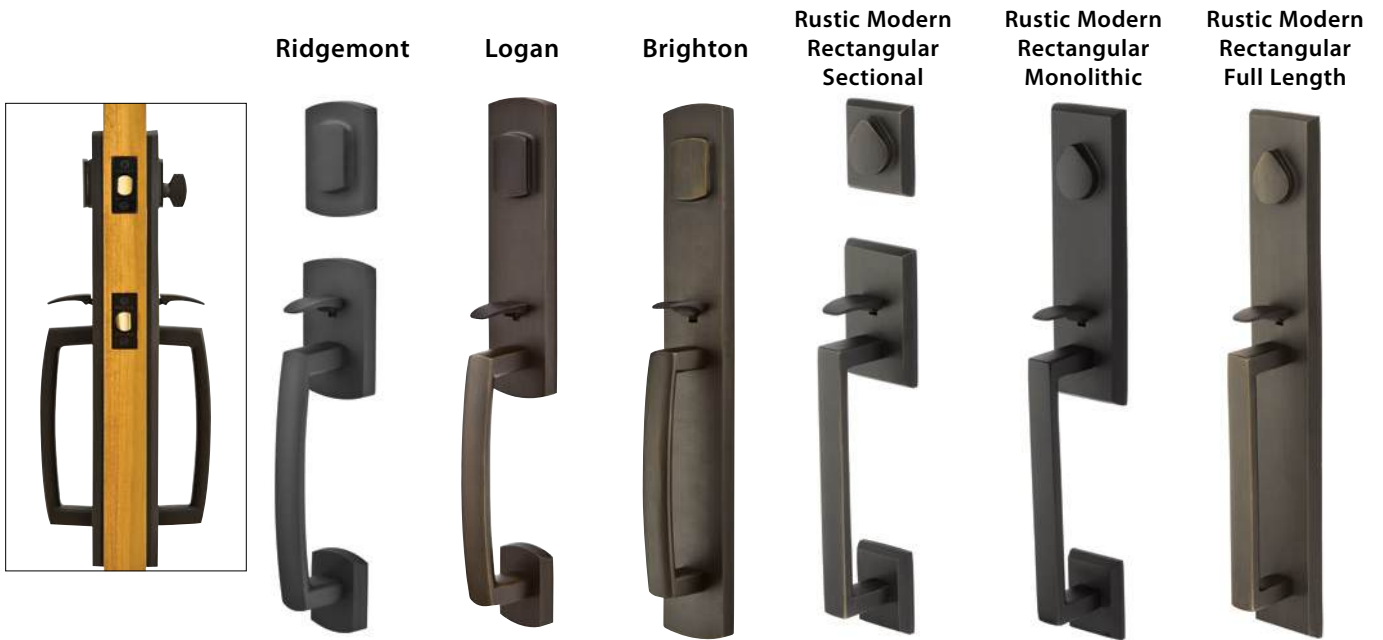

GRIP BY GRIP ENTRY SETS	Description	Product Code	Finish	List Price
RIDGEMONT	Single Cylinder	453727	Flat Black Bronze (FB) Medium Bronze (MB) Tumbled White Bronze (TWB)	\$981
	Double Cylinder	454727		\$981
	Dummy	455727		\$981
LOGAN Door Prep 5½" Center-to-Center	Single Cylinder	453828		\$1065
	Double Cylinder	454828		\$1065
	Dummy	455828		\$1065
BRIGHTON Door Prep 5½" Center-to-Center	Single Cylinder	453929		\$1170
	Double Cylinder	454929		\$1170
	Dummy	455929		\$1170

GRIP BY GRIP ENTRY SETS	Description	Product Code	Finish	List Price
RUSTIC MODERN RECTANGULAR SECTIONAL	Single Cylinder	453424	Flat Black Bronze (FB) Medium Bronze (MB) Tumbled White Bronze (TWB)	\$981
	Double Cylinder	454424		\$981
	Dummy	455424		\$981
RUSTIC MODERN RECTANGULAR MONOLITHIC Door Prep 5½" Center-to-Center	Single Cylinder	453525		\$1065
	Double Cylinder	454525		\$1065
	Dummy	455525		\$1065
RUSTIC MODERN RECTANGULAR FULL LENGTH Door Prep 5½" Center-to-Center	Single Cylinder	453646		\$1170
	Double Cylinder	454646		\$1170
	Dummy	455646		\$1170

- **Handing Not Required**
- Standard door thickness of 1¾". Specify if thicker.
- Standard latch is for 2¾" backset. Specify 2¾" backset if required.
- Latches come standard with square corner strike and face plates. Specify radius corners if required.
- Grip by Grip is a custom function made to order and requires an additional 2-3 day lead time.
- Available in Brass and Bronze handlesets. Please call for availability and pricing.

- Weiser® (WR5) Keyway**
- Specify by adding "W" to the beginning of product code.
 - No upcharge for cylinder substitution. Can be keyed into existing Weiser® system.

To order: **(W) Product Code + Finish + Add Door Thickness to Comments**



EMTEK SELECT Key In Levers
 Mix-Match Style & Finish
 for handles, stems and rosettes



**Key In L-Square . Terrazzo
 with Disk Rosette**
 5115US15.KLSUS15.TZLT.RH



**Key In L-Square . Tribeca
 with Disk Rosette**
 5115US26.KLSUS19.TRUS26.RH



**Key In L-Square . Knurled
 with Modern Rectangular Rosette**
 5123US4.KLSUS19.KNUS4.RH



**Key In L-Square . Rosso Levanto
 with Square Rosette**
 5122US7.KLSUS7.MRRD.RH

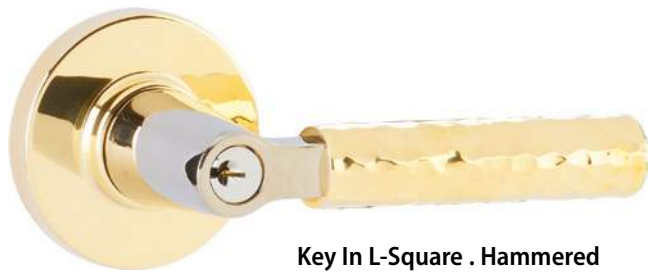

**Key In L-Square . Hammered
 with Disk Rosette**
 5115US3NL.KLSUS26.HAUS3NL.RH



**Key In L-Square . Dark Walnut
 with Modern Rectangular Rosette**
 5123US15.KLSUS15.WNWD.RH

To order: **5122US26 . KLSUS19 . TRUS26 . RH** + Add Door Thickness to Comments

Rosette (Function/Finish) + Stem (Style/Finish) + Handle (Style/Finish) + Handing (RH or LH)

Key In L-Square . Green Marble with Square Rosette



























Key In L-Square . White Marble with Disk Rosette



Key In L-Square . Straight Knurled with Square Rosette



KEY IN LEVERSET	Description	Product Code	STEM	HANDLE	List Price					
Square 	Single Cylinder	5122	 KEY IN L-SQUARE (KLS)	 FACETED (FA)	 KNURLED (KN)	\$311				
	Dummy	5022		 HAMMERED (HA)	 SMOOTH (SM)	\$311				
Disk 	Single Cylinder	5115		 KEY IN L-SQUARE (KLS)	 STRAIGHT KNURLED (SK)	 TRIBECA (TR)	\$311			
	Dummy	5015			 WHITE MARBLE (MRWH)	 GREEN MARBLE (MRGN)	\$311			
Modern Rectangular 	Single Cylinder	5123			 KEY IN L-SQUARE (KLS)	 ROSSO LEVANTO MARBLE (MRRD)	 LIGHT TERRAZZO (TZLT)	\$311		
	Dummy	5023				 DARK WALNUT (WNWD)		\$311		
Finish options for KEY IN ROSETTE, STEM and HANDLE						STEM AND HANDLE WILL BE PERMANENTLY AFFIXED.				
 Satin Brass (US4)	 French Antique (US7)	 Oil Rubbed Bronze (US10B)				 Polished Nickel - Lifetime (US14)	 Satin Nickel (US15)	 Flat Black (US19)	 Polished Chrome (US26)	 Unlacquered Brass (US3NL)*

*Unlacquered Brass (US3NL) finish available for a \$20 List Price upcharge per item.

>> Emtek SELECT Lever and Knob(s) with Marble, Terrazzo and Walnut handles feature a living finish that will age gracefully and evolve over time, enhancing the character of your space. Due to this unique characteristic, no finish warranty is offered on these products. All SELECT lever and knobs featuring Marble, Terrazzo and Walnut are intended for indoor use.

• Handing is Required for Leversets

- Standard latch is for 2¾" backset. Specify 2¾" backset if required. Complete set includes latch, strike plate.
- Latch, strike and face plates come standard with square corners. Specify radius corners if required.
- SELECT Brass Key In leversets may be ordered with any Brass Key In rosette at the list price shown above.

Weiser® (WR5) Keyway

- Specify by adding "W" to the beginning of product code.
- No upcharge for cylinder substitution.
- Can be keyed into existing Weiser® system.

To order: (W) Rosette/Finish . Stem/Finish . Handle/Finish . Handing + Add Door Thickness to Comments

Round Knob with Square Rosette



Round Knob with Disk Rosette



Round Knob with Modern Rectangular Rosette



Hanover Lever with Square Rosette



Helios Lever with Modern Rectangular Rosette



Luzern Lever with Square Rosette





Hercules Lever with Disk Rosette



Hercules Lever with Square Rosette



KEY IN KNOBSET/LEVERSET	Description	Product Code	Key In Knob/Lever Style	Finish	List Price
Square 	Single Cylinder	5122	Round Knob (ROU) Hanover Lever (HN) Helios Lever (HLO) Hercules Lever (HEC) Luzern Lever (LU)	Satin Brass (US4) French Antique (US7) Oil Rubbed Bronze (US10B) Polished Nickel - Lifetime (US14) Satin Nickel (US15) Flat Black (US19) Polished Chrome (US26) Unlacquered Brass (US3NL)*	\$275
	Dummy	5022			\$275
Disk 	Single Cylinder	5115			\$275
	Dummy	5015			\$275
Modern Rectangular 	Single Cylinder	5123			\$275
	Dummy	5023			\$275

*Unlacquered Brass (US3NL) finish available for a \$20 List Price upcharge per item.

Handing is Required for Leversets

- Standard latch is for 2¾" backset. Specify 2¾" backset if required. Complete set includes latch, strike plate.
- Latch, strike and face plates come standard with square corners. Specify radius corners if required.
- Modern Brass Key In knobs and leversets may be ordered with any Classic Brass Key In rosette at the list price shown above.

Weiser® (WR5) Keyway

- Specify by adding "W" to the beginning of product code.
- No upcharge for cylinder substitution.
- Can be keyed into existing Weiser® system.

Egg Knob
with Rectangular Rosette



Waverly Knob
with Regular Rosette



Providence Knob
with #8 Rosette



Rope Knob
with Rope Rosette



Cortina Lever
with Rectangular Rosette



Cortina Lever
with Regular Rosette







Cortina Lever
with #8 Rosette



Rope Lever
with Rope Rosette



KEY IN KNOBSET/LEVERSET	Description	Product Code	Key In Knob/Lever Style	Finish	List Price	
Regular 	Single Cylinder	5100	Egg Knob (E) Providence Knob (P) Rope Knob (RK) Waverly Knob (W) Cortina Lever (C) Rope Lever (RL)	Polished Brass - Lifetime (US3) Satin Brass (US4)** French Antique (US7) Oil Rubbed Bronze (US10B) Polished Nickel - Lifetime (US14)** Satin Nickel (US15) Pewter (US15A) Flat Black (US19)** Polished Chrome (US26) Unlacquered Brass (US3NL)*	\$275	
	Dummy	5150			\$275	
#8 	Single Cylinder	5108				\$275
	Dummy	5158			\$275	
Rectangular 	Single Cylinder	5121				\$275
	Dummy	5021			\$275	
Rope** 	Single Cylinder	5101				\$275
	Dummy	5151			\$275	

*Unlacquered Brass (US3NL) finish available for a \$20 List Price upcharge per item.

Finish **NOT available for Rope Rosette.

• Handing is Required for Leversets

- Standard latch is for 2¾" backset. Specify 2¾" backset if required. Complete set includes latch, strike plate.
- Latch, strike and face plates come standard with square corners. Specify radius corners if required.
- Classic Brass Key In knobsets and leversets may be ordered with any Modern Brass Key In rosette at the list price shown above.

Weiser® (WR5) Keyway

- Specify by adding "W" to the beginning of product code.
- No upcharge for cylinder substitution.
- Can be keyed into existing Weiser® system.

To order: **(W) Product Code + Key In Knob/Lever Style + Handing + Finish + Add Door Thickness to Comments**

Winchester Knob
with #3 Rosette



Durango Lever
with #1 Rosette





Winchester Knob
with #4 Rosette



Durango Lever
with #2 Rosette



KEY IN KNOBSET/LEVERSET	Description	Product Code	Key In Knob/Lever Style	Finish	List Price
#1 	Single Cylinder	5104	Winchester Knob (WC) Durango Lever (D)	Flat Black Bronze (FB) Medium Bronze (MB) Tumbled White Bronze (TWB)	\$302
	Dummy	5154			\$302
#2 	Single Cylinder	5102			\$302
	Dummy	5152			\$302
#3 	Single Cylinder	5103			\$302
	Dummy	5153			\$302
#4 	Single Cylinder	5114			\$302
	Dummy	5164			\$302

- **Handing is Required for Leversets**
- Standard latch is for 2³/₈" backset. Specify 2³/₄" backset if required. Complete set includes latch, strike plate.
- Latch, strike and face plates come standard with square corners. Specify radius corners if required.

Weiser® (WR5) Keyway

- Specify by adding "W" to the beginning of product code.
- No upcharge for cylinder substitution.
- Can be keyed into existing Weiser® system.

**Siena Lever
with #11 Rosette**





**Petal Knob
with #12 Rosette**



**Siena Lever
with #14 Rosette**



KEY IN KNOBSET/LEVERSET	Description	Product Code	Key In Knob/Lever Style	Finish	List Price	
#11 	Single Cylinder	54011	Petal Knob (PT) Siena Lever (SN)	Flat Black Bronze (FB) Medium Bronze (MB)	\$302	
	Dummy	54511			\$302	
#12 	Single Cylinder	54012				\$302
	Dummy	54512			\$302	
#14 	Single Cylinder	54014				\$302
	Dummy	54514			\$302	

**Hanover Lever
with Disc Rosette**
Stainless Steel



KEY IN LEVERSETS	Description	Product Code	Key In Lever Style	Finish	List Price
Disc 	Single Cylinder	S901	Hanover Lever (HN)	Brushed Stainless Steel (SS)	\$275
	Dummy	S951			\$275

- **Handing is Required for Leversets**
- Standard latch is for 2³/₈" backset. Specify 2³/₄" backset if required. Complete set includes latch, strike plate.
- Latch, strike and face plates come standard with square corners. Specify radius corners if required.

Weiser® (WR5) Keyway

- Specify by adding "W" to the beginning of product code.
- No upcharge for cylinder substitution.
- Can be keyed into existing Weiser® system.

SINGLE & TWO-POINT LOCKSETS - SELECT BRASS

SINGLE & TWO-POINT















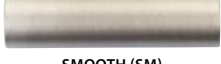





Modern Rectangular
Single Point with Key In L-Square . Knurled Lever



Modern Rectangular
Two-Point, Single Cylinder
with Key In L-Square . White Marble Lever



EMTEK SELECT

MODERN RECTANGULAR SINGLE POINT LOCKSET	Product Code	STEM	HANDLE	List Price		
Single Cylinder	5302	 KEY IN L-SQUARE (KLS)	 FACETED (FA)	 KNURLED (KN)	\$392	
Dummy	5352		 HAMMERED (HA)	 SMOOTH (SM)	\$392	
MODERN RECTANGULAR TWO-POINT LOCKSET	Product Code		 KEY IN L-SQUARE (KLS)	 STRAIGHT KNURLED (SK)	 TRIBECA (TR)	List Price
Single Cylinder	5312			 WHITE MARBLE (MRWH)	 GREEN MARBLE (MRGN)	\$449
Double Cylinder	5322	 ROSSO LEVANTO MARBLE (MRRD)		 LIGHT TERRAZZO (TZLT)	\$449	
Dummy	5362	 DARK WALNUT (WNWD)			\$449	
Finish options for SINGLE & TWO-POINT LOCKSET, STEM and HANDLE			STEM AND HANDLE WILL BE PERMANENTLY AFFIXED.			
						
Satin Brass (US4)	Oil Rubbed Bronze (US10B)	Polished Nickel - Lifetime (US14)	Satin Nickel (US15)	Flat Black (US19)	Polished Chrome (US26)	Unlacquered Brass (US3NL)*

>> Emtek SELECT Lever and Knob(s) with Marble, Terrazzo and Walnut handles feature a living finish that will age gracefully and evolve over time, enhancing the character of your space. Due to this unique characteristic, no finish warranty is offered on these products. All SELECT lever and knobs featuring Marble, Terrazzo and Walnut are intended for indoor use.

To order: **5302US19 . KLSUS14 . FAUS26 . RH** + Add Door Thickness to Comments

Lockset (Function/Finish) + Stem (Style/Finish) + Handle (Style/Finish) + Handing (RH or LH)

*Unlacquered Brass (US3NL) finish available for a \$20 List Price upcharge per item.

• Handing is Required for Leversets

- Standard latch is for 2¾" backset. Specify 2¾" backset if required. Complete set includes latch, strike plate.
- Latch, strike and face plates come standard with square corners. Specify radius corners if required.
- SELECT Brass Key In leversets may also be ordered with Annapolis trim style at the list price shown above.

Weiser® (WR5) Keyway

- Specify by adding "W" to the beginning of product code.
- No upcharge for cylinder substitution.
- Can be keyed into existing Weiser® system.

**Modern Rectangular
Single Point with Round Knobs**

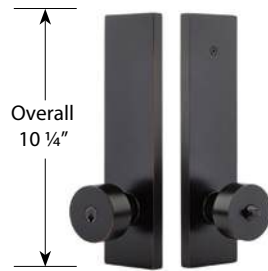

**Modern Rectangular
Dummy with Round Knobs**



MODERN RECTANGULAR SINGLE POINT LOCKSET	Product Code	Key In Knob/Lever Style	Finish	List Price
Single Cylinder	5302	Round Knob (ROU) Hanover Lever (HN) Helios Lever (HLO)	Satin Brass (US4) Oil Rubbed Bronze (US10B) Polished Nickel - Lifetime (US14)	\$356
Dummy	5352	Hercules Lever (HEC) Luzern Lever (LU)	Satin Nickel (US15) Flat Black (US19) Polished Chrome (US26) Unlacquered Brass (US3NL)*	\$356

**Modern Rectangular
Two-Point, Single Cylinder
with Helios Levers**

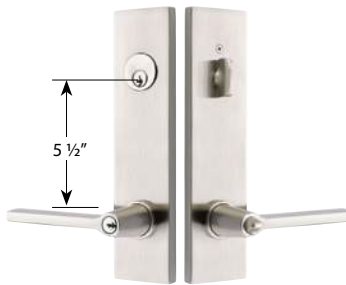

**Modern Rectangular
Two-Point, Double Cylinder
with Luzern Levers**



**Modern Rectangular
Two-Point, Dummy
with Hanover Levers**



MODERN RECTANGULAR TWO-POINT LOCKSET	Product Code	Key In Knob/Lever Style	Finish	List Price
Single Cylinder	5312	Round Knob (ROU) Hanover Lever (HN) Helios Lever (HLO)	Satin Brass (US4) Oil Rubbed Bronze (US10B) Polished Nickel - Lifetime (US14)	\$413
Double Cylinder	5322	Hercules Lever (HEC) Luzern Lever (LU)	Satin Nickel (US15) Flat Black (US19) Polished Chrome (US26) Unlacquered Brass (US3NL)*	\$413
Dummy	5362			\$413

*Unlacquered Brass (US3NL) finish available for a \$20 List Price upcharge per item.

• Handing Required for Leversets

- Standard latch is for 2 3/8" backset. Specify 2 3/4" backset if required. Complete set includes latch and strike plate.
- Latch, strike and face plates come standard with square corners. Specify radius corners if required.
- Any Key In Knob/Lever style options listed on this page can be used with Annapolis trim style.

Weiser® (WR5) Keyway

- Specify by adding "W" to the beginning of product code.
- No upcharge for cylinder substitution.
- Can be keyed into existing Weiser® system.

To order: (W) Product Code + Key In Knob/Lever Style + Handing + Finish + Add Door Thickness to Comments

Annapolis
Single Point with Providence Knobs



Annapolis
Dummy with Egg Knobs



ANNAPOLIS SINGLE POINT LOCKSET	Product Code	Key In Knob/Lever Style	Finish	List Price
Single Cylinder	5308	Egg Knob (E) Providence Knob (P) Rope Knob (RK)	Polished Brass - Lifetime (US3) Satin Brass (US4)** French Antique (US7)	\$356
Dummy	5358	Waverly Knob (W) Cortina Lever (C) Rope Lever (RL)	Oil Rubbed Bronze (US10B) Polished Nickel - Lifetime (US14)** Satin Nickel (US15) Pewter (US15A) Flat Black (US19)** Polished Chrome (US26) Unlacquered Brass (US3NL)*	\$356

Annapolis
Two-Point, Single Cylinder
with Waverly Knobs

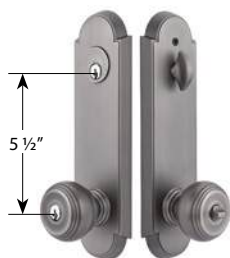

Annapolis
Two-Point, Double Cylinder
with Cortina Levers



Annapolis
Two-Point, Dummy
with Cortina Levers



ANNAPOLIS TWO-POINT LOCKSET	Product Code	Key In Knob/Lever Style	Finish	List Price
Single Cylinder	5318	Egg Knob (E) Providence Knob (P) Rope Knob (RK)	Polished Brass - Lifetime (US3) Satin Brass (US4)** French Antique (US7)	\$413
Double Cylinder	5328	Waverly Knob (W) Cortina Lever (C) Rope Lever (RL)	Oil Rubbed Bronze (US10B) Polished Nickel - Lifetime (US14)** Satin Nickel (US15) Pewter (US15A) Flat Black (US19)** Polished Chrome (US26) Unlacquered Brass (US3NL)*	\$413
Dummy	5368			\$413

*Unlacquered Brass (US3NL) finish available for a \$20 List Price upcharge per item. ** Finish **NOT** available for Rope Key In Knob/Lever.

• Handing Required for Leversets

- Standard latch is for 2 3/8" backset. Specify 2 3/4" backset if required. Complete set includes latch and strike plate.
- Latch, strike and face plates come standard with square corners. Specify radius corners if required.
- Any Key In Knob/Lever style options listed on this page can be used with Modern Rectangular trim style.

Weiser® (WR5) Keyway

- Specify by adding "W" to the beginning of product code.
- No upcharge for cylinder substitution.
- Can be keyed into existing Weiser® system.

EMPowered™ 2 Smart Lock Upgrade with Wi-Fi

Includes Yale Access Module, Wi-Fi Bridge and DoorSense™.
For use in the US and Canada only, see pages 28-33 for details.



BRASS DEADBOLTS

- Schlage® C Keyway
- Standard Door Prep and Installation
- Solid Brass Cylinder, Housing, Collar, Thumbturn and Rosette
- Hardened Steel Bolt
- Heavy Gauge Steel Understrike
- Brass Trim Strike Shipped with Every Deadbolt

BRASS DEADBOLTS WITH EMPOWERED™ 2 SMART LOCK

- Complete set includes both 2¾" and 2¾" latches, strike plates and four (4) AA batteries.
- EMPowered™ 2 Deadbolt only available with square corner latch face plate.
- Emtek's standard mechanical and finish warranties apply, along with a two (2) year warranty on electronic components.



SQUARE DEADBOLT

Includes Extension Collar for Thin Doors

Single Cylinder

EMPowered Upgrade

Product Code

Finish**

List Price

EMPowered Upgrade List Price

EMP2

8469

Satin Brass (US4)
French Antique (US7)
Oil Rubbed Bronze (US10B)
Polished Nickel - Lifetime (US14)
Satin Nickel (US15)
Flat Black (US19)
Polished Chrome (US26)
Unlacquered Brass (US3NL)*

\$110

\$495

Double Cylinder

8369

\$118

MODERN DISC DEADBOLT

Includes Extension Collar for Thin Doors

Single Cylinder

EMPowered Upgrade

Product Code

Finish**

List Price

EMPowered Upgrade List Price

EMP2

8423

Satin Brass (US4)
Oil Rubbed Bronze (US10B)
Polished Nickel - Lifetime (US14)
Satin Nickel (US15)
Flat Black (US19)
Polished Chrome (US26)
Unlacquered Brass (US3NL)*

\$110

\$495

Double Cylinder

8323

\$118

MODERN DEADBOLT

Includes Extension Collar for Thin Doors

Single Cylinder

EMPowered Upgrade

Product Code

Finish**

List Price

EMPowered Upgrade List Price

EMP2

8467

Satin Brass (US4)
Oil Rubbed Bronze (US10B)
Polished Nickel - Lifetime (US14)
Satin Nickel (US15)
Flat Black (US19)
Polished Chrome (US26)
Unlacquered Brass (US3NL)*

\$110

\$495

Double Cylinder

8367

\$118

NEOS DEADBOLT

Includes Extension Collar for Thin Doors

Single Cylinder

EMPowered Upgrade

Product Code

Finish**

List Price

EMPowered Upgrade List Price

EMP2

8475

Satin Brass (US4)
Oil Rubbed Bronze (US10B)
Polished Nickel - Lifetime (US14)
Satin Nickel (US15)
Flat Black (US19)
Polished Chrome (US26)
Unlacquered Brass (US3NL)*

\$110

\$495

Double Cylinder

8375

\$118



*Unlacquered Brass (US3NL) finish available for a \$20 List Price upcharge per item.

**EMPowered™ 2 Finishes: Satin Brass (US4), Oil Rubbed Bronze (US10B), Polished Nickel - Lifetime (US14), Satin Nickel (US15), Flat Black (US19), Polished Chrome (US26) and Unlacquered Brass (US3NL).

• Handing Not Required

- Standard door thickness of 1¾". Specify if thicker. EMPowered™ 2 fits door thickness up to 2¼".
- Standard latch is for 2¾" backset. Specify 2¾" backset if required.
- Latch, strike and face plates come standard with square corners. Specify radius corners if required.

Weiser® (WR5) Keyway

- Specify by adding "W" to the beginning of product code.
- No upcharge for cylinder substitution. Can be keyed into existing Weiser® system.



URBAN MODERN DEADBOLT Includes Extension Collar for Thin Doors	EMPowered Upgrade	Product Code	Finish**	List Price	EMPowered Upgrade List Price
Single Cylinder	EMP2	8426	Satin Brass (US4) Oil Rubbed Bronze (US10B) Polished Nickel - Lifetime (US14)	\$110	\$495
Double Cylinder		8326	Satin Nickel (US15) Flat Black (US19) Polished Chrome (US26) Unlacquered Brass (US3NL)*	\$118	



QUINCY DEADBOLT Includes Extension Collar for Thin Doors	EMPowered Upgrade	Product Code	Finish**	List Price	EMPowered Upgrade List Price
Single Cylinder	EMP2	8478	Polished Brass - Lifetime (US3) Satin Brass (US4)	\$110	\$495
Double Cylinder		8378	French Antique (US7) Oil Rubbed Bronze (US10B) Polished Nickel - Lifetime (US14)	\$118	



REGULAR DEADBOLT	EMPowered Upgrade	Product Code	Finish**	List Price	EMPowered Upgrade List Price
Single Cylinder	EMP2	8450	Satin Nickel (US15) Pewter (US15A) Flat Black (US19) Polished Chrome (US26) Unlacquered Brass (US3NL)*	\$92	\$477
Double Cylinder		8350		\$104	



LOW PROFILE DEADBOLT Includes Extension Collar for Thin Doors	EMPowered Upgrade	Product Code	Finish**	List Price	EMPowered Upgrade List Price
Single Cylinder	EMP2	8455		\$92	\$477
Double Cylinder		8355		\$104	



WILSHIRE DEADBOLT Includes Extension Collar for Thin Doors	EMPowered Upgrade	Product Code	Finish**	List Price	EMPowered Upgrade List Price
Single Cylinder	EMP2	8479		\$110	\$495
Double Cylinder		8379		\$118	

*Unlacquered Brass (US3NL) finish available for a \$20 List Price upcharge per item.

**EMPowered™ 2 Finishes: Satin Brass (US4), Oil Rubbed Bronze (US10B), Polished Nickel - Lifetime (US14), Satin Nickel (US15), Flat Black (US19), Polished Chrome (US26) and Unlacquered Brass (US3NL).

• **Handing Not Required**

- Standard door thickness of 1¾". Specify if thicker. EMPowered™ 2 fits door thickness up to 2¼".
- Standard latch is for 2¾" backset. Specify 2¾" backset if required.
- Latch, strike and face plates come standard with square corners. Specify radius corners if required.

Weiser® (WR5) Keyway

- Specify by adding "W" to the beginning of product code.
- No upcharge for cylinder substitution. Can be keyed into existing Weiser® system.

EMPowered™ 2 Smart Lock Upgrade with Wi-Fi

Includes Yale Access Module, Wi-Fi Bridge and DoorSense™.
For use in the US and Canada only, see pages 28-33 for details.



BRASS DEADBOLTS

- Schlage® C Keyway
- Standard Door Prep and Installation
- Solid Brass Cylinder, Housing, Collar, Thumbturn and Rosette
- Hardened Steel Bolt
- Heavy Gauge Steel Understrike
- Brass Trim Strike Shipped with Every Deadbolt

BRASS DEADBOLTS WITH EMPOWERED™ 2 SMART LOCK

- Complete set includes both 2 $\frac{3}{8}$ " and 2 $\frac{3}{4}$ " latches, strike plates and four (4) AA batteries.
- EMPowered™ 2 Deadbolt only available with square corner latch face plate.
- Emtek's standard mechanical and finish warranties apply, along with a two (2) year warranty on electronic components.



RECTANGULAR DEADBOLT Includes Extension Collar for Thin Doors	EMPowered Upgrade	Product Code	Finish**	List Price	EMPowered Upgrade List Price
Single Cylinder	EMP2	8468	Polished Brass - Lifetime (US3) Satin Brass (US4) French Antique (US7) Oil Rubbed Bronze (US10B) Polished Nickel - Lifetime (US14) Satin Nickel (US15) Pewter (US15A) Flat Black (US19) Polished Chrome (US26) Unlacquered Brass (US3NL)*	\$110	\$495
Double Cylinder		8368		\$118	
SARATOGA DEADBOLT Includes Extension Collar for Thin Doors	EMPowered Upgrade	Product Code		List Price	EMPowered Upgrade List Price
Single Cylinder	EMP2	8458		\$110	\$495
Double Cylinder		8358		\$118	
#8 DEADBOLT	EMPowered Upgrade	Product Code		List Price	EMPowered Upgrade List Price
Single Cylinder <i>Includes extension collar for thin doors</i>	EMP2	8466		\$110	\$495
Double Cylinder		8366		\$118	



*Unlacquered Brass (US3NL) finish available for a \$20 List Price upcharge per item.

**EMPowered™ 2 Finishes: Satin Brass (US4), Oil Rubbed Bronze (US10B), Polished Nickel - Lifetime (US14), Satin Nickel (US15), Flat Black (US19), Polished Chrome (US26) and Unlacquered Brass (US3NL).

• Handing Not Required

- Standard door thickness of 1 $\frac{3}{4}$ ". Specify if thicker. EMPowered™ 2 fits door thickness up to 2 $\frac{1}{4}$ ".
- Standard latch is for 2 $\frac{3}{8}$ " backset. Specify 2 $\frac{3}{4}$ " backset if required.
- Latch, strike and face plates come standard with square corners. Specify radius corners if required.

Weiser® (WR5) Keyway

- Specify by adding "W" to the beginning of product code.
- No upcharge for cylinder substitution. Can be keyed into existing Weiser® system.

To order: (W) Function + Product Code + Finish + Add Door Thickness to Comments



ROPE DEADBOLT Includes Extension Collar for Thin Doors		EMPowered Upgrade	Product Code	Finish**	List Price	EMPowered Upgrade List Price
Single Cylinder	EMP2	8464	Polished Brass - Lifetime (US3) French Antique (US7) Oil Rubbed Bronze (US10B) Satin Nickel (US15) Pewter (US15A) Polished Chrome (US26) Unlacquered Brass (US3NL)*	\$110	\$495	
Double Cylinder		8364				
KNOXVILLE DEADBOLT Includes Extension Collar for Thin Doors		EMPowered Upgrade	Product Code	List Price	EMPowered Upgrade List Price	
Single Cylinder	EMP2	8459		\$110	\$495	
Double Cylinder		8359				
ARTS & CRAFTS DEADBOLT Includes Extension Collar for Thin Doors		EMPowered Upgrade	Product Code	Finish**	List Price	EMPowered Upgrade List Price
Single Cylinder	EMP2	8454	Oil Rubbed Bronze (US10B) Satin Nickel (US15) Flat Black (US19) Unlacquered Brass (US3NL)*	\$110	\$495	
Double Cylinder		8354				



*Unlacquered Brass (US3NL) finish available for a \$20 List Price upcharge per item.

**EMPowered™ 2 Finishes: Satin Brass (US4), Oil Rubbed Bronze (US10B), Polished Nickel - Lifetime (US14), Satin Nickel (US15), Flat Black (US19), Polished Chrome (US26) and Unlacquered Brass (US3NL).

• **Handing Not Required**

- Standard door thickness of 1¾". Specify if thicker. EMPowered™ 2 fits door thickness up to 2¼".
- Standard latch is for 2¾" backset. Specify 2¾" backset if required.
- Latch, strike and face plates come standard with square corners. Specify radius corners if required.

Weiser® (WR5) Keyway

- Specify by adding "W" to the beginning of product code.
- No upcharge for cylinder substitution. Can be keyed into existing Weiser® system.

STANDARD WITH SANDCAST BRONZE DEADBOLTS

- Schlage® C Keyway
- Standard Door Prep and Installation
- Solid Brass Cylinder
- Hardened Steel Bolt
- Heavy Gauge Steel Understrike
- Brass Trim Strike Shipped with Every Deadbolt



REGULAR SANDCAST BRONZE DEADBOLT	Product Code	Finish	List Price
Single Cylinder	8450	Flat Black Bronze (FB) Medium Bronze (MB) Tumbled White Bronze (TWB)	\$123
Double Cylinder	8350		\$134

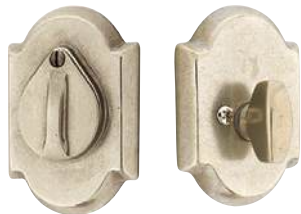

#1 SANDCAST BRONZE DEADBOLT WITH FLAP	Product Code	List Price
Single Cylinder	8457	\$123
Double Cylinder	8357	\$134



#3 SANDCAST BRONZE DEADBOLT WITH FLAP	Product Code	List Price
Single Cylinder	8465	\$123
Double Cylinder	8365	\$134



RUSTIC MODERN RECTANGULAR SANDCAST BRONZE DEADBOLT WITH FLAP	Product Code	List Price
Single Cylinder	8477	\$123
Double Cylinder	8377	\$134



RIDGEMONT SANDCAST BRONZE DEADBOLT WITH FLAP	Product Code	List Price
Single Cylinder	8476	\$123
Double Cylinder	8376	\$134

- **Handing Not Required**
- Standard door thickness of 1¾". Specify if thicker.
- Standard latch is for 2¾" backset. Specify 2¾" backset if required.
- Latch, strike and face plates come standard with square corners. Specify radius corners if required.

- **Weiser® (WRS) Keyway**
- Specify by adding "W" to the beginning of product code.
- No upcharge for cylinder substitution. Can be keyed into existing Weiser® system.

To order: **(W) Product Code + Finish + Add Door Thickness to Comments**

STANDARD WITH TUSCANY BRONZE DEADBOLTS

- Schlage® C Keyway
- Standard Door Prep and Installation
- Solid Brass Cylinder
- Tuscany Bronze Collar and Rosette
- Hardened Steel Bolt
- Heavy Gauge Steel Understrike
- Brass Trim Strike Shipped with Every Deadbolt



TUSCANY BRONZE DEADBOLT Includes Extension Collar for Thin Doors	Product Code	Finish	List Price
Single Cylinder	8456	Flat Black Bronze (FB) Medium Bronze (MB)	\$123
Double Cylinder	8356		\$134
CLASSIC TUSCANY BRONZE DEADBOLT Includes Extension Collar for Thin Doors	Product Code		List Price
Single Cylinder	8471		\$123
Double Cylinder	8371		\$134
OCTAGON TUSCANY BRONZE DEADBOLT	Product Code		List Price
Single Cylinder	8460		\$123
Double Cylinder	8360		\$134
#11 TUSCANY BRONZE DEADBOLT	Product Code		List Price
Single Cylinder	8472		\$123
Double Cylinder	8372		\$134
#14 TUSCANY BRONZE DEADBOLT	Product Code		List Price
Single Cylinder	8473		\$123
Double Cylinder	8373		\$134

• **Handing Not Required**

- Standard door thickness of 1¾". Specify if thicker.
- Standard latch is for 2¾" backset. Specify 2¾" backset if required.
- Latch, strike and face plates come standard with square corners. Specify radius corners if required.

Weiser® (WR5) Keyway

- Specify by adding "W" to the beginning of product code.
- No upcharge for cylinder substitution. Can be keyed into existing Weiser® system.

STANDARD WITH WROUGHT STEEL DEADBOLTS

- Schlage® C Keyway
- Standard Door Prep and Installation
- Solid Brass Cylinder
- Hardened Steel Bolt
- Heavy Gauge Steel Understrike
- Brass Trim Strike Shipped with Every Deadbolt



WROUGHT STEEL #1 DEADBOLT	Product Code	Finish	List Price
Single Cylinder	8461	Flat Black Steel (FBS) Satin Steel (SWS)	\$110
Double Cylinder	8361		\$118
WROUGHT STEEL #2 DEADBOLT	Product Code		List Price
Single Cylinder	8452		\$110
Double Cylinder	8350		\$118
WROUGHT STEEL #3 DEADBOLT	Product Code		List Price
Single Cylinder	8463		\$110
Double Cylinder	8363		\$118

STANDARD WITH STAINLESS STEEL DEADBOLTS

- Schlage® C Keyway
- Standard Door Prep and Installation
- Solid Brass Cylinder
- Stainless Steel Collar and Rosette
- Hardened Steel Bolt
- Heavy Gauge Steel Understrike
- Stainless Steel Trim Strike Shipped with Every Deadbolt



STAINLESS STEEL MODERN DISC DEADBOLT Includes Extension Collar for Thin Doors	Product Code	Finish	List Price
Single Cylinder	S50004	Brushed Stainless Steel (SS)	\$110
Double Cylinder	S50024		\$118
STAINLESS STEEL ROUND DEADBOLT Includes Extension Collar for Thin Doors	Product Code		List Price
Single Cylinder	S50001		\$110
Double Cylinder	S50002		\$118
STAINLESS STEEL SQUARE DEADBOLT Includes Extension Collar for Thin Doors	Product Code		List Price
Single Cylinder	S50003		\$110
Double Cylinder	S50023		\$118

• Handing Not Required

- Standard door thickness of 1¾". Specify if thicker.
- Standard latch is for 2¾" backset. Specify 2¾" backset if required.
- Latch, strike and face plates come standard with square corners. Specify radius corners if required.

Weiser® (WR5) Keyway

- Specify by adding "W" to the beginning of product code.
- No upcharge for cylinder substitution. Can be keyed into existing Weiser® system.

To order: **(W) Product Code + Finish + Add Door Thickness to Comments**

SINGLE SIDED DEADBOLTS

Operated by Thumbturn from Inside Only. No Cylinder.

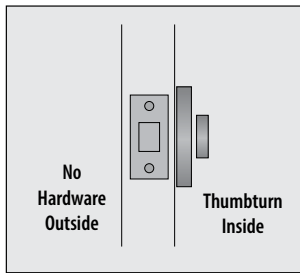

STANDARD WITH SINGLE SIDED DEADBOLTS

- Includes Deadbolt Mechanism and Strike Plate
- For Inside Installation and Appearance
- No Cylinder or Collar
- Hardened Steel Bolt



SINGLE SIDED DEADBOLTS	Product Code	Finish	List Price
Modern Disc	8523	Satin Brass (US4) French Antique (US7)	\$72
Square	8569	Oil Rubbed Bronze (US10B) Polished Nickel - Lifetime (US14) Satin Nickel (US15) Flat Black (US19) Polished Chrome (US26) Unlacquered Brass (US3NL)*	
SINGLE SIDED DEADBOLTS	Product Code	Finish	List Price
Modern	8567	Satin Brass (US4) Oil Rubbed Bronze (US10B) Polished Nickel - Lifetime (US14)	\$72
Neos	8575	Satin Nickel (US15) Flat Black (US19)	
Urban Modern	8580	Polished Chrome (US26) Unlacquered Brass (US3NL)*	
SINGLE SIDED DEADBOLTS	Product Code	Finish	List Price
Regular	8550	Satin Brass (US4) Polished Brass - Lifetime (US3)	\$72
#8	8566	French Antique (US7) Oil Rubbed Bronze (US10B)	
Rectangular	8568	Polished Nickel - Lifetime (US14) Satin Nickel (US15)	
Wilshire	8579	Pewter (US15A) Flat Black (US19)	
Saratoga	8558	Polished Chrome (US26) Unlacquered Brass (US3NL)*	
Quincy	8578		
SINGLE SIDED DEADBOLTS	Product Code	Finish	List Price
Rope	8564	Polished Brass - Lifetime (US3) French Antique (US7)	\$72
Knoxville	8559	Oil Rubbed Bronze (US10B) Satin Nickel (US15) Pewter (US15A) Polished Chrome (US26) Unlacquered Brass (US3NL)*	
SINGLE SIDED DEADBOLT	Product Code	Finish	List Price
Arts & Crafts	8554	Oil Rubbed Bronze (US10B) Satin Nickel (US15) Flat Black (US19) Unlacquered Brass (US3NL)*	\$72

*Unlacquered Brass (US3NL) finish available for a \$10 List Price upcharge per item.

- Handing Not Required
- Standard door thickness of 1 3/4". Specify if thicker.
- Standard latch is for 2 3/8" backset. Specify 2 3/4" backset if required.
- Latch, strike and face plates come standard with square corners. Specify radius corners if required.

Operated by Thumbturn from Inside Only. No Cylinder.

#1
Sandcast
Bronze



#2
Sandcast
Bronze



#3
Sandcast
Bronze



#4
Sandcast
Bronze



Tuscany



Octagon



#11
Tuscany



#14
Tuscany



#1
Wrought Steel



#2
Wrought Steel



#3
Wrought Steel



Round
Stainless Steel



Square
Stainless Steel



Modern Disc
Stainless Steel



SINGLE SIDED DEADBOLTS	Product Code	Finish	List Price
#1 Sandcast Bronze	8557	Flat Black Bronze (FB) Medium Bronze (MB) Tumbled White Bronze (TWB)	\$78
#2 Sandcast Bronze	8550		
#3 Sandcast Bronze	8565		
#4 Sandcast Bronze	8574		

SINGLE SIDED DEADBOLTS	Product Code	Finish	List Price
Tuscany Bronze	8556	Flat Black Bronze (FB) Medium Bronze (MB)	\$78
Octagon	8560		
#11 Tuscany Bronze	8572		
#14 Tuscany Bronze	8573		

SINGLE SIDED DEADBOLTS	Product Code	Finish	List Price
#1 Wrought Steel	8551	Flat Black Steel (FBS) Satin Steel (SWS)	\$72
#2 Wrought Steel	8552		
#3 Wrought Steel	8553		

SINGLE SIDED DEADBOLTS	Product Code	Finish	List Price
Round Stainless Steel	S52005	Brushed Stainless Steel (SS)	\$72
Square Stainless Steel	S52006		
Modern Disc Stainless Steel	S52007		

- **Handing Not Required**
- Standard door thickness of 1 3/4". Specify if thicker.
- Standard latch is for 2 3/8" backset. Specify 2 3/4" backset if required.
- Latch, strike and face plates come standard with square corners. Specify radius corners if required.

Passage



Exterior



Interior

Single Keyed



Exterior



Interior

Privacy



Exterior



Interior

Double Keyed



Exterior



Interior

Dummy, Non-Keyed



Exterior



Interior

Dummy, Keyed



Exterior



Interior

Modern Sideplate
7" Non-Keyed
with L-Square . Knurled Lever

























Modern Sideplate
7" Thumbturn Privacy
with Conical . Knurled Knobs



Modern Sideplate
9" Non-Keyed
with Conical . White Marble Knob



EMTEK SELECT

MODERN 7" NON-KEYED	Product Code	STEM	HANDLE/KNOB	List Price		
Passage	8111	 L-SQUARE (LS)	 FACETED (FA)	\$302		
Privacy	8211		 HAMMERED (HA)	\$302		
Dummy	8011		 STRAIGHT KNURLED (SK)	\$302		
MODERN 7" THUMBTURN PRIVACY	Product Code	STEM	HANDLE/KNOB	List Price		
3 3/8" Center-to-Center	8229	 T-BAR (TA)	 WHITE MARBLE (MRWH)	\$311		
		 R-BAR (RA)	 GREEN MARBLE (MRGN)			
MODERN 9" NON-KEYED	Product Code	STEM	HANDLE/KNOB	List Price		
Passage	8113	 CONICAL (CC)	 KNURLED (KNK)	\$328		
Privacy	8213		 STRAIGHT KNURLED (SKK)	\$328		
Dummy	8013		 LIGHT TERRAZZO (TZKLT)	 WHITE MARBLE (MRKWH)	\$328	
			 GREEN MARBLE (MRKGN)	\$328		
			 DARK WALNUT (WNKWD)			
			 ROSSO LEVANTO MARBLE (MRKRD)			
Finish options for SIDEPLATE, STEM and HANDLE/KNOB			STEM AND HANDLE/KNOB WILL BE PERMANENTLY AFFIXED.			
						
Satin Brass (US4)	Oil Rubbed Bronze (US10B)	Polished Nickel - Lifetime (US14)	Satin Nickel (US15)	Flat Black (US19)	Polished Chrome (US26)	Unlacquered Brass (US3NL)*

>> Emtek SELECT Lever and Knob(s) with Marble, Terrazzo and Walnut handles feature a living finish that will age gracefully and evolve over time, enhancing the character of your space. Due to this unique characteristic, no finish warranty is offered on these products. All SELECT lever and knobs featuring Marble, Terrazzo and Walnut are intended for indoor use.

• Hanging Required for Leversets on Thumbturn Privacy

- Standard 2 1/8" door prep. Standard latch is for 2 3/4" backset. Specify 2 3/4" backset if required.
- Supplied with a 28° rotation latch for Leversets, standard rotation latch for Knobsets.
- Complete set includes latch, strike plate and dust box.
- Latch, strike and face plates come standard with square corners. Specify radius corners if required.
- SELECT knobsets/leversets may also be ordered with any Brass sideplate at the list price shown above.

*Unlacquered Brass (US3NL) finish available for a \$20 List Price upcharge per item.

SIDEPLATE LOCKSETS - BRASS TUBULAR

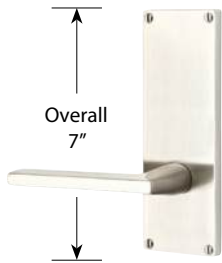

MODERN 7" NON-KEYED	Product Code	Knob or Lever Style	Finish	List Price
Passage	8111	See Pages 10-23 for Brass Knob & Lever Options***	Satin Brass (US4)	\$266
Privacy	8211		Oil Rubbed Bronze (US10B) Polished Nickel - Lifetime (US14) Satin Nickel (US15)	
Dummy	8011		Flat Black (US19) Polished Chrome (US26) Unlacquered Brass (US3NL)*	\$266



MODERN 3 5/8" C-TO-C KEYED	Product Code	Knob or Lever Style	Finish	List Price
Single Cylinder	8112	See Pages 10-23 for Brass Knob & Lever Options***	Satin Brass (US4)	\$308
Double Cylinder	8212		Oil Rubbed Bronze (US10B) Polished Nickel - Lifetime (US14) Satin Nickel (US15)	
Dummy	8012		Flat Black (US19) Polished Chrome (US26) Unlacquered Brass (US3NL)*	\$308



MODERN 9" NON-KEYED	Product Code	Knob or Lever Style	Finish	List Price
Passage	8113	See Pages 10-23 for Brass Knob & Lever Options***	Satin Brass (US4)	\$292
Privacy	8213		Oil Rubbed Bronze (US10B) Polished Nickel - Lifetime (US14) Satin Nickel (US15)	
Dummy	8013		Flat Black (US19) Polished Chrome (US26) Unlacquered Brass (US3NL)*	\$292



EMPowered Interior Option

Inside trim is pre-configured with Square Rosette

MODERN 5 1/2" C-TO-C KEYED	EMPowered Upgrade	Product Code	Knob or Lever Style	Finish**	List Price	EMPowered Upgrade List Price
Single Cylinder	EMP2	8114	See Pages 10-23 for Brass Knob & Lever Options***	Satin Brass (US4)	\$315	\$700
Double Cylinder		8214		Oil Rubbed Bronze (US10B) Polished Nickel - Lifetime (US14) Satin Nickel (US15)		
Dummy		8014		Flat Black (US19) Polished Chrome (US26) Unlacquered Brass (US3NL)*	\$315	
INTERCONNECT DEVICE	Product Code	Not Available for Double Cylinder or EMPowered™ 2 Upgrade. 28° Latch Not Available for Use with Interconnect Device. Handing Required.			List Price	
Modern 5 1/2" C-to-C Keyed	443				\$98	

*Unlacquered Brass (US3NL) finish available for a \$20 List Price upcharge per item.

**EMPowered™ 2 Finishes: Satin Brass (US4), Oil Rubbed Bronze (US10B), Polished Nickel - Lifetime (US14), Satin Nickel (US15), Flat Black (US19), Polished Chrome (US26) and Unlacquered Brass (US3NL).

***SELECT knobs/leversets may be ordered with any Brass sideplate at a higher list price. See SELECT Brass Sideplate Lockset page for pricing.

• Handing Required for Leversets in Keyed Function or if Interconnect Device is Specified

- Standard 2 1/8" door prep. Standard latch is for 2 3/8" backset. Specify 2 3/4" backset if required.
- Latch, strike and face plates come standard with square corners. Specify radius corners if required.
- Supplied with standard rotation latch. To order 28° Rotation latch, add product code **Latch28** and list price \$7

Weiser® (WR5) Keyway

- Specify by adding "W" to the beginning of product code.
- No upcharge for cylinder substitution. Can be keyed into existing Weiser® system.



QUINCY 7 1/8" NON-KEYED	Product Code	Knob or Lever Style	Finish	List Price
Passage	8104	See Pages 10-23 for Brass Knob & Lever Options***	Polished Brass - Lifetime (US3) French Antique (US7)	\$266
Privacy	8204		Oil Rubbed Bronze (US10B) Polished Nickel - Lifetime (US14)	\$266
Dummy	8054		Satin Nickel (US15) Pewter (US15A) Flat Black (US19) Polished Chrome (US26) Unlacquered Brass (US3NL)*	\$266



QUINCY 3 5/8" C-TO-C KEYED	Product Code	Knob or Lever Style	Finish	List Price
Single Cylinder	8080	See Pages 10-23 for Brass Knob & Lever Options***	Polished Brass - Lifetime (US3) French Antique (US7)	\$308
Double Cylinder	8081		Oil Rubbed Bronze (US10B) Polished Nickel - Lifetime (US14)	\$308
Dummy	8085		Satin Nickel (US15) Pewter (US15A) Flat Black (US19) Polished Chrome (US26) Unlacquered Brass (US3NL)*	\$308



QUINCY 9" NON-KEYED	Product Code	Knob or Lever Style	Finish	List Price
Passage	8704	See Pages 10-23 for Brass Knob & Lever Options***	Polished Brass - Lifetime (US3) French Antique (US7)	\$292
Privacy	8804		Oil Rubbed Bronze (US10B) Polished Nickel - Lifetime (US14)	\$292
Dummy	8854		Satin Nickel (US15) Pewter (US15A) Flat Black (US19) Polished Chrome (US26) Unlacquered Brass (US3NL)*	\$292



QUINCY 5 1/2" C-TO-C KEYED	EM Powered Upgrade	Product Code	Knob or Lever Style	Finish**	List Price	EM Powered Upgrade List Price
Single Cylinder	EMP2	8980	See Pages 10-23 for Brass Knob & Lever Options***	Polished Brass - Lifetime (US3) French Antique (US7)	\$315	Includes Yale Access Module, Wi-Fi Bridge and DoorSense™. For use in the US and Canada only, see pages 28-33 for details.
Double Cylinder		8981		Oil Rubbed Bronze (US10B) Polished Nickel - Lifetime (US14)	\$315	
Dummy		8985		Satin Nickel (US15) Pewter (US15A) Flat Black (US19) Polished Chrome (US26) Unlacquered Brass (US3NL)*	\$315	

Inside trim is pre-configured with Quincy Rosette

INTERCONNECT DEVICE	Product Code	Not Available for Double Cylinder or EM Powered™ 2 Upgrade. 28° Latch Not Available for Use with Interconnect Device. Handing Required.	List Price
Quincy 5 1/2" C-to-C Keyed	443		\$98

*Unlacquered Brass (US3NL) finish available for a \$20 List Price upcharge per item.

**EM Powered™ 2 Finishes: Satin Brass (US4), Oil Rubbed Bronze (US10B), Polished Nickel - Lifetime (US14), Satin Nickel (US15), Flat Black (US19), Polished Chrome (US26) and Unlacquered Brass (US3NL).

***SELECT knobs/leversets may be ordered with any Brass sideplate at a higher list price. See SELECT Brass Sideplate Lockset page for pricing.

• **Handing Required for Leversets in Keyed Function or if Interconnect Device is Specified**

- Standard 2 1/8" door prep. Standard latch is for 2 3/8" backset. Specify 2 3/4" backset if required.
- Latch, strike and face plates come standard with square corners. Specify radius corners if required.
- Supplied with standard rotation latch. To order 28° Rotation latch, add product code **Latch28** and list price **\$7**

Weiser® (WRS) Keyway

- Specify by adding "W" to the beginning of product code.
- No upcharge for cylinder substitution. Can be keyed into existing Weiser® system.

To order: (W) Function + Product Code + Knob/Lever Style + Handing + Finish + Add Door Thickness to Comments

SIDEPLATE LOCKSETS - BRASS TUBULAR

SIDEPLATE LOCKSETS



DELAWARE 7 1/8" NON-KEYED	Product Code	Knob or Lever Style	Finish	List Price
Passage	8016	See Pages 10-23 for Brass Knob & Lever Options***	Polished Brass - Lifetime (US3)	\$266
Privacy	8026		French Antique (US7)	
Dummy	8006		Oil Rubbed Bronze (US10B) Polished Nickel - Lifetime (US14) Satin Nickel (US15) Pewter (US15A) Flat Black (US19) Polished Chrome (US26) Unlacquered Brass (US3NL)*	



DELAWARE 3 5/8" C-TO-C KEYED	Product Code	Knob or Lever Style	Finish	List Price
Single Cylinder	8066	See Pages 10-23 for Brass Knob & Lever Options***	Polished Brass - Lifetime (US3)	\$308
Double Cylinder	8166		French Antique (US7)	
Dummy	8061		Oil Rubbed Bronze (US10B) Polished Nickel - Lifetime (US14) Satin Nickel (US15) Pewter (US15A) Flat Black (US19) Polished Chrome (US26) Unlacquered Brass (US3NL)*	



DELAWARE 9" NON-KEYED	Product Code	Knob or Lever Style	Finish	List Price
Passage	8716	See Pages 10-23 for Brass Knob & Lever Options***	Polished Brass - Lifetime (US3)	\$292
Privacy	8816		French Antique (US7)	
Dummy	8998		Oil Rubbed Bronze (US10B) Polished Nickel - Lifetime (US14) Satin Nickel (US15) Pewter (US15A) Flat Black (US19) Polished Chrome (US26) Unlacquered Brass (US3NL)*	



DELAWARE 5 1/2" C-TO-C KEYED	EMPowered Upgrade	Product Code	Knob or Lever Style	Finish**	List Price	EMPowered Upgrade List Price
Single Cylinder	EMP2	8996	See Pages 10-23 for Brass Knob & Lever Options***	Polished Brass - Lifetime (US3)	\$315	\$700 Includes Yale Access Module, Wi-Fi Bridge and DoorSense™. For use in the US and Canada only, see pages 28-33 for details.
Double Cylinder		8997		French Antique (US7)		
Dummy		8856		Oil Rubbed Bronze (US10B) Polished Nickel - Lifetime (US14) Satin Nickel (US15) Pewter (US15A) Flat Black (US19) Polished Chrome (US26) Unlacquered Brass (US3NL)*		

Inside trim is pre-configured with #8 Rosette

INTERCONNECT DEVICE	Product Code	Not Available for Double Cylinder or EMPowered™ 2 Upgrade. 28° Latch Not Available for Use with Interconnect Device. Handing Required.	List Price
Delaware 5 1/2" C-to-C Keyed	443		\$98

*Unlacquered Brass (US3NL) finish available for a \$20 List Price upcharge per item.

**EMPowered™ 2 Finishes: Satin Brass (US4), Oil Rubbed Bronze (US10B), Polished Nickel - Lifetime (US14), Satin Nickel (US15), Flat Black (US19), Polished Chrome (US26) and Unlacquered Brass (US3NL).

***SELECT knobsets/leversets may be ordered with any Brass sideplate at a higher list price. See SELECT Brass Sideplate Lockset page for pricing.

• Handing Required for Leversets in Keyed Function or if Interconnect Device is Specified

- Standard 2 1/8" door prep. Standard latch is for 2 3/8" backset. Specify 2 3/4" backset if required.
- Latch, strike and face plates come standard with square corners. Specify radius corners if required.
- Supplied with standard rotation latch. To order 28° Rotation latch, add product code **Latch28** and list price \$7

Weiser® (WRS) Keyway

- Specify by adding "W" to the beginning of product code.
- No upcharge for cylinder substitution. Can be keyed into existing Weiser® system.



COLONIAL 7 1/8" NON-KEYED	Product Code	Knob or Lever Style	Finish	List Price
Passage	8010	See Pages 10-23 for Brass Knob & Lever Options***	Polished Brass - Lifetime (US3)	\$266
Privacy	8020		French Antique (US7)	
Dummy	8001		Oil Rubbed Bronze (US10B)	\$266
			Polished Nickel - Lifetime (US14)	\$266
			Satin Nickel (US15)	
			Pewter (US15A)	
			Flat Black (US19)	
			Polished Chrome (US26)	
			Unlacquered Brass (US3NL)*	



COLONIAL 3 5/8" C-TO-C KEYED	Product Code	Knob or Lever Style	Finish	List Price
Single Cylinder	8060	See Pages 10-23 for Brass Knob & Lever Options***	Polished Brass - Lifetime (US3)	\$308
Double Cylinder	8160		French Antique (US7)	
Dummy	8065		Oil Rubbed Bronze (US10B)	\$308
			Polished Nickel - Lifetime (US14)	\$308
			Satin Nickel (US15)	
			Pewter (US15A)	
			Flat Black (US19)	
			Polished Chrome (US26)	
			Unlacquered Brass (US3NL)*	



COLONIAL 9" NON-KEYED	Product Code	Knob or Lever Style	Finish	List Price
Passage	8711	See Pages 10-23 for Brass Knob & Lever Options***	Polished Brass - Lifetime (US3)	\$292
Privacy	8811		French Antique (US7)	
Dummy	8851		Oil Rubbed Bronze (US10B)	\$292
			Polished Nickel - Lifetime (US14)	\$292
			Satin Nickel (US15)	
			Pewter (US15A)	
			Flat Black (US19)	
			Polished Chrome (US26)	
			Unlacquered Brass (US3NL)*	



COLONIAL 5 1/2" C-TO-C KEYED	EMPowered Upgrade	Product Code	Knob or Lever Style	Finish**	List Price	EMPowered Upgrade List Price
Single Cylinder	EMP2	8990	See Pages 10-23 for Brass Knob & Lever Options***	Polished Brass - Lifetime (US3)	\$315	Includes Yale Access Module, Wi-Fi Bridge and DoorSense™. For use in the US and Canada only, see pages 28-33 for details.
Double Cylinder		8991		French Antique (US7)		
Dummy		8995		Oil Rubbed Bronze (US10B)	\$315	
				Polished Nickel - Lifetime (US14)	\$315	
				Satin Nickel (US15)		
				Pewter (US15A)		
				Flat Black (US19)		
				Polished Chrome (US26)		
				Unlacquered Brass (US3NL)*		

Inside trim is pre-configured with #8 Rosette

INTERCONNECT DEVICE	Product Code	Not Available for Double Cylinder or EMPowered™ 2 Upgrade. 28° Latch Not Available for Use with Interconnect Device. Handing Required.	List Price
Colonial 5 1/2" C-to-C Keyed	443		\$98

*Unlacquered Brass (US3NL) finish available for a \$20 List Price upcharge per item.

**EMPowered™ 2 Finishes: Satin Brass (US4), Oil Rubbed Bronze (US10B), Polished Nickel - Lifetime (US14), Satin Nickel (US15), Flat Black (US19), Polished Chrome (US26) and Unlacquered Brass (US3NL).

***SELECT knobsets/leversets may be ordered with any Brass sideplate at a higher list price. See SELECT Brass Sideplate Lockset page for pricing.

• **Handing Required for Leversets in Keyed Function or if Interconnect Device is Specified**

- Standard 2 1/8" door prep. Standard latch is for 2 3/8" backset. Specify 2 3/4" backset if required.
- Latch, strike and face plates come standard with square corners. Specify radius corners if required.
- Supplied with standard rotation latch. To order 28° Rotation latch, add product code **Latch28** and list price **\$7**

Weiser® (WRS) Keyway

- Specify by adding "W" to the beginning of product code.
- No upcharge for cylinder substitution. Can be keyed into existing Weiser® system.

To order: **(W) Function + Product Code + Knob/Lever Style + Handing + Finish + Add Door Thickness to Comments**

SIDEPLATE LOCKSETS - BRASS TUBULAR

SIDEPLATE LOCKSETS



ROPE 7 1/2" NON-KEYED	Product Code	Knob or Lever Style	Finish	List Price
Passage	7109	See Pages 10-23 for Brass Knob & Lever Options***	Polished Brass - Lifetime (US3)	\$266
Privacy	7209		French Antique (US7)	
Dummy	7059		Oil Rubbed Bronze (US10B)	\$266
		Satin Nickel (US15)	\$266	
			Unlacquered Brass (US3NL)*	\$266



ROPE 3 5/8" C-T-O-C KEYED	Product Code	Knob or Lever Style	Finish	List Price
Single Cylinder	7090	See Pages 10-23 for Brass Knob & Lever Options***	Polished Brass - Lifetime (US3)	\$308
Double Cylinder	7091		French Antique (US7)	
Dummy	7095		Oil Rubbed Bronze (US10B)	\$308
		Satin Nickel (US15)	\$308	
			Unlacquered Brass (US3NL)*	\$308

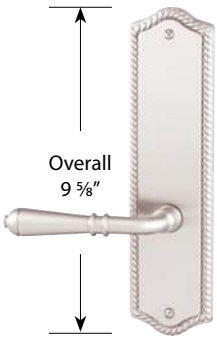

ROPE 9 5/8" NON-KEYED	Product Code	Knob or Lever Style	Finish	List Price
Passage	7710	See Pages 10-23 for Brass Knob & Lever Options***	Polished Brass - Lifetime (US3)	\$292
Privacy	7810		French Antique (US7)	
Dummy	7850		Oil Rubbed Bronze (US10B)	\$292
		Satin Nickel (US15)	\$292	
			Unlacquered Brass (US3NL)*	\$292



ROPE 5 1/2" C-T-O-C KEYED	EM Powered Upgrade	Product Code	Knob or Lever Style	Finish**	List Price	EM Powered Upgrade List Price
Single Cylinder	EMP2	7990	See Pages 10-23 for Brass Knob & Lever Options***	Polished Brass - Lifetime (US3)	\$315	\$700
Double Cylinder		7991		French Antique (US7)		
Dummy		7995		Oil Rubbed Bronze (US10B)	\$315	
			Satin Nickel (US15)	\$315		
				Unlacquered Brass (US3NL)*	\$315	

Includes Yale Access Module, Wi-Fi Bridge and DoorSense™. For use in the US and Canada only, see pages 28-33 for details.

Inside trim is pre-configured with Rope Rosette

INTERCONNECT DEVICE	Product Code	List Price
Rope 5 1/2" C-to-C Keyed	443	\$98

Not Available for Double Cylinder or EM Powered™ 2 Upgrade.
28° Latch Not Available for Use with Interconnect Device.
Handing Required.

*Unlacquered Brass (US3NL) finish available for a \$20 List Price upcharge per item.

**EM Powered™ 2 Finishes: Satin Brass (US4), Oil Rubbed Bronze (US10B), Polished Nickel - Lifetime (US14), Satin Nickel (US15), Flat Black (US19), Polished Chrome (US26) and Unlacquered Brass (US3NL).

***SELECT knobsets/leversets may be ordered with any Brass sideplate at a higher list price. See SELECT Brass Sideplate Lockset page for pricing.

• Handing Required for Leversets in Keyed Function or if Interconnect Device is Specified

- Standard 2 1/8" door prep. Standard latch is for 2 3/4" backset. Specify 2 3/4" backset if required.
- Latch, strike and face plates come standard with square corners. Specify radius corners if required.
- Supplied with standard rotation latch. To order 28° Rotation latch, add product code **Latch28** and list price \$7

Weiser® (WR5) Keyway

- Specify by adding "W" to the beginning of product code.
- No upcharge for cylinder substitution. Can be keyed into existing Weiser® system.



WILSHIRE 7" NON-KEYED	Product Code	Knob or Lever Style	Finish	List Price
Passage	8135	See Pages 10-23 for Brass Knob & Lever Options***	Polished Brass - Lifetime (US3) Satin Brass (US4)	\$266
Privacy	8235		French Antique (US7) Oil Rubbed Bronze (US10B)	\$266
Dummy	8035		Polished Nickel - Lifetime (US14) Satin Nickel (US15) Pewter (US15A) Flat Black (US19) Polished Chrome (US26) Unlacquered Brass (US3NL)*	\$266



Inside trim is pre-configured with Wilshire Rosette

WILSHIRE 5½" C-TO-C KEYED	EMPowered Upgrade	Product Code	Knob or Lever Style	Finish**	List Price	EMPowered Upgrade List Price
Single Cylinder	EMP2	8821	See Pages 10-23 for Brass Knob & Lever Options***	Polished Brass - Lifetime (US3) Satin Brass (US4)	\$315	\$700 Includes Yale Access Module, Wi-Fi Bridge and DoorSense™. For use in the US and Canada only, see pages 28-33 for details.
Double Cylinder		8822		French Antique (US7) Oil Rubbed Bronze (US10B)	\$315	
Dummy		8820		Polished Nickel - Lifetime (US14) Satin Nickel (US15) Pewter (US15A) Flat Black (US19) Polished Chrome (US26) Unlacquered Brass (US3NL)*	\$315	
INTERCONNECT DEVICE		Product Code	Not Available for Double Cylinder or EMPowered™ 2 Upgrade. 28° Latch Not Available for Use with Interconnect Device. Handing Required.		List Price	
Wilshire 5½" C-to-C Keyed		443			\$98	

*Unlacquered Brass (US3NL) finish available for a \$20 List Price upcharge per item.

**EMPowered™ 2 Finishes: Satin Brass (US4), Oil Rubbed Bronze (US10B), Polished Nickel - Lifetime (US14), Satin Nickel (US15), Flat Black (US19), Polished Chrome (US26) and Unlacquered Brass (US3NL).

***SELECT knobsets/leversets may be ordered with any Brass sideplate at a higher list price. See SELECT Brass Sideplate Lockset page for pricing.

• Handing Required for Leversets in Keyed Function or if Interconnect Device is Specified

- Standard 2½" door prep. Standard latch is for 2¾" backset. Specify 2¾" backset if required.
- Latch, strike and face plates come standard with square corners. Specify radius corners if required.
- Supplied with standard rotation latch. To order 28° Rotation latch, add product code **Latch28** and list price **\$7**

Weiser® (WR5) Keyway

- Specify by adding "W" to the beginning of product code.
- No upcharge for cylinder substitution. Can be keyed into existing Weiser® system.

To order: **(W) Function + Product Code + Knob/Lever Style + Handing + Finish + Add Door Thickness to Comments**

SIDEPLATE LOCKSETS - BRASS TUBULAR



BELMONT 7 1/2" NON-KEYED	Product Code	Knob or Lever Style	Finish	List Price
Passage	8102	See Pages 10-23 for Brass Knob & Lever Options**	Polished Brass - Lifetime (US3)	\$266
Privacy	8202		French Antique (US7)	
Dummy	8052		Oil Rubbed Bronze (US10B)	\$266
		Satin Nickel (US15)	\$266	
			Unlacquered Brass (US3NL)*	\$266



BELMONT 3 5/8" C-TO-C KEYED	Product Code	Knob or Lever Style	Finish	List Price
Single Cylinder	8070	See Pages 10-23 for Brass Knob & Lever Options**	Polished Brass - Lifetime (US3)	\$308
Double Cylinder	8071		French Antique (US7)	
Dummy	8075		Oil Rubbed Bronze (US10B)	\$308
		Satin Nickel (US15)	\$308	
			Unlacquered Brass (US3NL)*	\$308



VICTORIA 7 3/4" NON-KEYED	Product Code	Knob or Lever Style	Finish	List Price
Passage	8103	See Pages 10-23 for Brass Knob & Lever Options**	Polished Brass - Lifetime (US3)	\$266
Privacy	8203		French Antique (US7)	
Dummy	8053		Oil Rubbed Bronze (US10B)	\$266
		Satin Nickel (US15)	\$266	
			Unlacquered Brass (US3NL)*	\$266



VICTORIA 3 5/8" C-TO-C KEYED	Product Code	Knob or Lever Style	Finish	List Price
Single Cylinder	8090	See Pages 10-23 for Brass Knob & Lever Options***	Polished Brass - Lifetime (US3)	\$308
Double Cylinder	8091		French Antique (US7)	
Dummy	8095		Oil Rubbed Bronze (US10B)	\$308
		Satin Nickel (US15)	\$308	
			Unlacquered Brass (US3NL)*	\$308

*Unlacquered Brass (US3NL) finish available for a \$20 List Price upcharge per item.

**SELECT knobsets/leversets may be ordered with any Brass sideplate at a higher list price. See SELECT Brass Sideplate Lockset page for pricing.

• Handing Required for Leversets in Keyed Function

- Standard 2 1/8" door prep. Standard latch is for 2 3/8" backset. Specify 2 3/4" backset if required.
- Latch, strike and face plates come standard with square corners. Specify radius corners if required.
- Supplied with standard rotation latch. To order 28° Rotation latch, add product code **Latch28** and list price **\$7**

Weiser® (WR5) Keyway

- Specify by adding "W" to the beginning of product code.
- No upcharge for cylinder substitution. Can be keyed into existing Weiser® system.

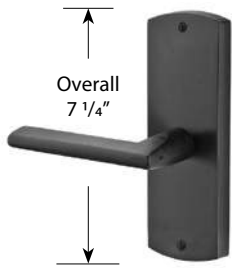

MISSOULA 7 1/4" NON-KEYED	Product Code	Knob or Lever Style	Finish	List Price
Passage	71023	See Pages 24-25 for Sandcast Bronze Knob & Lever Options.	Flat Black Bronze (FB) Medium Bronze (MB) Tumbled White Bronze (TWB)	\$292
Privacy	72023			\$292
Dummy	70063	See Pages 22-23 for Glass & Porcelain Knob Options.		\$292



MISSOULA 3 5/8" C-TO-C KEYED	Product Code	Knob or Lever Style	Finish	List Price
Single Cylinder	7370	See Pages 24-25 for Sandcast Bronze Knob & Lever Options.	Flat Black Bronze (FB) Medium Bronze (MB) Tumbled White Bronze (TWB)	\$343
Double Cylinder	7371			\$343
Dummy	7375	See Pages 22-23 for Glass & Porcelain Knob Options.		\$343

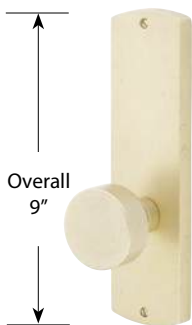

MISSOULA 9" NON-KEYED	Product Code	Knob or Lever Style	Finish	List Price
Passage	7522	See Pages 24-25 for Sandcast Bronze Knob & Lever Options.	Flat Black Bronze (FB) Medium Bronze (MB) Tumbled White Bronze (TWB)	\$308
Privacy	7622			\$308
Dummy	7562	See Pages 22-23 for Glass & Porcelain Knob Options.		\$308



MISSOULA 5 1/2" C-TO-C KEYED	Product Code	Knob or Lever Style	Finish	List Price
Single Cylinder	7570	See Pages 24-25 for Sandcast Bronze Knob & Lever Options.	Flat Black Bronze (FB) Medium Bronze (MB) Tumbled White Bronze (TWB)	\$356
Double Cylinder	7571			\$356
Dummy	7575	See Pages 22-23 for Glass & Porcelain Knob Options.		\$356

INTERCONNECT DEVICE	Product Code		List Price
Missoula 5 1/2" C-to-C Keyed	443	Not Available for Double Cylinder. 28° Latch Not Available for Use with Interconnect Device. Handing Required.	\$98

• Handing Required for Leversets in Keyed Function or if Interconnect Device is Specified

- Standard 2 1/8" door prep. Standard latch is for 2 3/8" backset. Specify 2 3/4" backset if required.
- Latch, strike and face plates come standard with square corners. Specify radius corners if required.
- Supplied with standard rotation latch. To order 28° Rotation latch, add product code **Latch28** and list price **\$7**

Weiser® (WR5) Keyway

- Specify by adding "W" to the beginning of product code.
- No upcharge for cylinder substitution. Can be keyed into existing Weiser® system.

To order: **(W) Product Code + Knob/Lever Style + Handing + Finish + Add Door Thickness to Comments**

SIDEPLATE LOCKSETS - SANDCAST BRONZE TUBULAR



RECTANGULAR 7" NON-KEYED	Product Code	Knob or Lever Style	Finish	List Price
Passage	71013	See Pages 24-25 for Sandcast Bronze Knob & Lever Options.	Flat Black Bronze (FB) Medium Bronze (MB) Tumbled White Bronze (TWB)	\$292
Privacy	72013			\$292
Dummy	70053			See Pages 22-23 for Glass & Porcelain Knob Options.

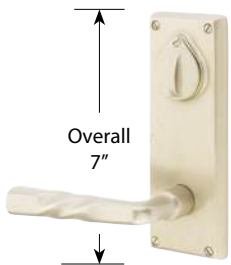

RECTANGULAR 3 5/8" C-TO-C KEYED	Product Code	Knob or Lever Style	Finish	List Price
Single Cylinder	7360	See Pages 24-25 for Sandcast Bronze Knob & Lever Options.	Flat Black Bronze (FB) Medium Bronze (MB) Tumbled White Bronze (TWB)	\$343
Double Cylinder	7361			\$343
Dummy	7365			See Pages 22-23 for Glass & Porcelain Knob Options.



RECTANGULAR 8 7/8" NON-KEYED	Product Code	Knob or Lever Style	Finish	List Price
Passage	7512	See Pages 24-25 for Sandcast Bronze Knob & Lever Options.	Flat Black Bronze (FB) Medium Bronze (MB) Tumbled White Bronze (TWB)	\$308
Privacy	7612			\$308
Dummy	7552			See Pages 22-23 for Glass & Porcelain Knob Options.



RECTANGULAR 5 1/2" C-TO-C KEYED	Product Code	Knob or Lever Style	Finish	List Price
Single Cylinder	7560	See Pages 24-25 for Sandcast Bronze Knob & Lever Options.	Flat Black Bronze (FB) Medium Bronze (MB) Tumbled White Bronze (TWB)	\$356
Double Cylinder	7561			\$356
Dummy	7565			See Pages 22-23 for Glass & Porcelain Knob Options.

INTERCONNECT DEVICE	Product Code		List Price
Rectangular 5 1/2" C-to-C Keyed	443	Not Available for Double Cylinder. 28° Latch Not Available for Use with Interconnect Device. Handing Required.	\$98

• Handing Required for Leversets in Keyed Function or if Interconnect Device is Specified

- Standard 2 1/8" door prep. Standard latch is for 2 3/8" backset. Specify 2 3/4" backset if required.
- Latch, strike and face plates come standard with square corners. Specify radius corners if required.
- Supplied with standard rotation latch. To order 28° Rotation latch, add product code **Latch28** and list price **\$7**

Weiser® (WR5) Keyway

- Specify by adding "W" to the beginning of product code.
- No upcharge for cylinder substitution. Can be keyed into existing Weiser® system.



#5 BRONZE 7 1/4" NON-KEYED	Product Code	Knob or Lever Style	Finish	List Price
Passage	7107	See Pages 24-25 for Sandcast Bronze Knob & Lever Options.	Flat Black Bronze (FB) Medium Bronze (MB) Tumbled White Bronze (TWB)	\$292
Privacy	7207			\$292
Dummy	7057	See Pages 22-23 for Glass & Porcelain Knob Options.		\$292



#5 BRONZE 3 5/8" C-TO-C KEYED	Product Code	Knob or Lever Style	Finish	List Price
Single Cylinder	7070	See Pages 24-25 for Sandcast Bronze Knob & Lever Options.	Flat Black Bronze (FB) Medium Bronze (MB) Tumbled White Bronze (TWB)	\$343
Double Cylinder	7071			\$343
Dummy	7075	See Pages 22-23 for Glass & Porcelain Knob Options.		\$343



#5 BRONZE 9 1/4" NON-KEYED	Product Code	Knob or Lever Style	Finish	List Price
Passage	7707	See Pages 24-25 for Sandcast Bronze Knob & Lever Options.	Flat Black Bronze (FB) Medium Bronze (MB) Tumbled White Bronze (TWB)	\$308
Privacy	7807			\$308
Dummy	7757	See Pages 22-23 for Glass & Porcelain Knob Options.		\$308

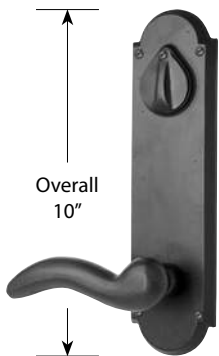

#5 BRONZE 5 1/2" C-TO-C KEYED	Product Code	Knob or Lever Style	Finish	List Price
Single Cylinder	7670	See Pages 24-25 for Sandcast Bronze Knob & Lever Options.	Flat Black Bronze (FB) Medium Bronze (MB) Tumbled White Bronze (TWB)	\$356
Double Cylinder	7671			\$356
Dummy	7675	See Pages 22-23 for Glass & Porcelain Knob Options.		\$356

INTERCONNECT DEVICE	Product Code		List Price
#5 5 1/2" C-to-C Keyed	443	Not Available for Double Cylinder. 28° Latch Not Available for Use with Interconnect Device. Handing Required.	\$98

• Handing Required for Leversets in Keyed Function or if Interconnect Device is Specified

- Standard 2 1/8" door prep. Standard latch is for 2 3/8" backset. Specify 2 3/4" backset if required.
- Latch, strike and face plates come standard with square corners. Specify radius corners if required.
- Supplied with standard rotation latch. To order 28° Rotation latch, add product code **Latch28** and list price **\$7**

Weiser® (WR5) Keyway

- Specify by adding "W" to the beginning of product code.
- No upcharge for cylinder substitution. Can be keyed into existing Weiser® system.

To order: **(W) Product Code + Knob/Lever Style + Handing + Finish** + Add Door Thickness to Comments

SIDEPLATE LOCKSETS - TUSCANY BRONZE TUBULAR



#16 TUSCANY 8 1/4" NON-KEYED	Product Code	Knob or Lever Style	Finish	List Price
Passage	6102	See Pages 24-25 for Tuscany Bronze Knob & Lever Options.	Flat Black Bronze (FB) Medium Bronze (MB)	\$292
Privacy	6202			\$292
Dummy	6052	See Pages 22-23 for Glass & Porcelain Knob Options.		\$292



#16 TUSCANY 3 5/8" C-TO-C KEYED	Product Code	Knob or Lever Style	Finish	List Price
Single Cylinder	6020	See Pages 24-25 for Tuscany Bronze Knob & Lever Options.	Flat Black Bronze (FB) Medium Bronze (MB)	\$343
Double Cylinder	6021			\$343
Dummy	6025	See Pages 22-23 for Glass & Porcelain Knob Options.		\$343



#16 TUSCANY 10 1/8" NON-KEYED	Product Code	Knob or Lever Style	Finish	List Price
Passage	6702	See Pages 24-25 for Tuscany Bronze Knob & Lever Options.	Flat Black Bronze (FB) Medium Bronze (MB)	\$308
Privacy	6802			\$308
Dummy	6752	See Pages 22-23 for Glass & Porcelain Knob Options.		\$308



#16 TUSCANY 5 1/2" C-TO-C KEYED	Product Code	Knob or Lever Style	Finish	List Price
Single Cylinder	6620	See Pages 24-25 for Tuscany Bronze Knob & Lever Options.	Flat Black Bronze (FB) Medium Bronze (MB)	\$356
Double Cylinder	6621			\$356
Dummy	6625	See Pages 22-23 for Glass & Porcelain Knob Options.		\$356

INTERCONNECT DEVICE	Product Code		List Price
#16 Tuscany 5 1/2" C-to-C Keyed	443	Not Available for Double Cylinder. 28° Latch Not Available for Use with Interconnect Device. Handing Required.	\$98

• Handing Required for Leversets in Keyed Function or if Interconnect Device is Specified

- Standard 2 1/8" door prep. Standard latch is for 2 3/8" backset. Specify 2 3/4" backset if required.
- Latch, strike and face plates come standard with square corners. Specify radius corners if required.
- Supplied with standard rotation latch. To order 28° Rotation latch, add product code **Latch28** and list price **\$7**

Weiser® (WR5) Keyway

- Specify by adding "W" to the beginning of product code.
- No upcharge for cylinder substitution. Can be keyed into existing Weiser® system.



#5 WROUGHT STEEL 7 1/8" NON-KEYED	Product Code	Knob or Lever Style	Finish	List Price
Passage	7105	See Pages 26-27 for Wrought Steel Knob & Lever Options.	Flat Black Steel (FBS) Satin Steel (SWS)	\$266
Privacy	7205			\$266
Dummy	7055	See Pages 22-23 for Glass & Porcelain Knob Options.		\$266

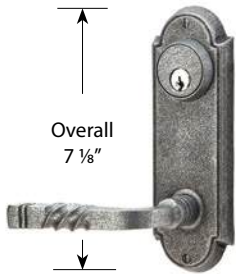

#5 WROUGHT STEEL 3 5/8" C-TO-C KEYED	Product Code	Knob or Lever Style	Finish	List Price
Single Cylinder	7010	See Pages 26-27 for Wrought Steel Knob & Lever Options.	Flat Black Steel (FBS) Satin Steel (SWS)	\$308
Double Cylinder	7011			\$308
Dummy	7015	See Pages 22-23 for Glass & Porcelain Knob Options.		\$308

• Handing Required for Leversets in Keyed Function

- Standard 2 1/8" door prep. Standard latch is for 2 3/8" backset. Specify 2 3/4" backset if required.
- Latch, strike and face plates come standard with square corners. Specify radius corners if required.
- Supplied with standard rotation latch. To order 28° Rotation latch, add product code **Latch28** and list price \$7

Weiser® (WRS) Keyway

- Specify by adding "W" to the beginning of product code.
- No upcharge for cylinder substitution. Can be keyed into existing Weiser® system.



STAINLESS STEEL 8" NON-KEYED	Product Code	Knob or Lever Style	Finish	List Price
Passage	S801	See Pages 26-27 for Stainless Steel Knob & Lever Options.	Brushed Stainless Steel (SS)	\$292
Privacy	S802			\$292
Dummy	S800			\$292



STAINLESS STEEL 5 1/2" C-TO-C KEYED	Product Code	Knob or Lever Style	Finish	List Price
Single Cylinder	S811	See Pages 26-27 for Stainless Steel Knob & Lever Options.	Brushed Stainless Steel (SS)	\$315
Double Cylinder	S812			\$315
Dummy	S810			\$315

INTERCONNECT DEVICE	Product Code		List Price
Stainless Steel 5 1/2" C-to-C Keyed	443	Not Available for Double Cylinder. 28° Latch Not Available for Use with Interconnect Device. Handing Required.	\$98

• Handing Required for Leversets in Keyed Function or if Interconnect Device is Specified

- Standard 2 1/8" door prep. Standard latch is for 2 3/8" backset. Specify 2 3/4" backset if required.
- Latch, strike and face plates come standard with square corners. Specify radius corners if required.
- Supplied with standard rotation latch. To order 28° Rotation latch, add product code **Latch28** and list price \$7

Weiser® (WRS) Keyway

- Specify by adding "W" to the beginning of product code.
- No upcharge for cylinder substitution. Can be keyed into existing Weiser® system.

To order: **(W) Product Code + Knob/Lever Style + Handing + Finish + Add Door Thickness to Comments**

Modern Plates
with Round Knobs



Delaware Plates
with Providence Glass Knobs



Colonial Plates
with Cortina Levers



Quincy Plates
with Egg Knobs



Belmont Plates
with Belmont Knobs



Victoria Plates
with Elan Levers



Rope Plates
with Rope Levers



THUMBTURN PRIVACY NON-KEYED STYLE 3 3/8" Center-to-Center		Optional Upgrade	Product Code	Knob / Lever Style	Finish	List Price	Interior Mortise List Price
Modern Plate	M	8229	See Pages 10-23 for Brass Knob & Lever Options**	Satin Brass (US4) Oil Rubbed Bronze (US10B) Polished Nickel - Lifetime (US14) Satin Nickel (US15) Flat Black (US19) Polished Chrome (US26) Unlacquered Brass (US3NL)*	\$275	\$475	
Delaware Plate	M	8228			Polished Brass - Lifetime (US3) French Antique (US7)	\$275	\$475
Colonial Plate	M	8022			Oil Rubbed Bronze (US10B) Polished Nickel - Lifetime (US14) Satin Nickel (US15)	\$275	\$475
Quincy Plate	M	8226			Pewter (US15A) Flat Black (US19) Polished Chrome (US26) Unlacquered Brass (US3NL)*	\$275	\$475
Belmont Plate	M	8224			Polished Brass - Lifetime (US3) French Antique (US7)	\$275	\$475
Victoria Plate	M	8225			Oil Rubbed Bronze (US10B) Satin Nickel (US15) Unlacquered Brass (US3NL)*	\$275	\$475
Rope Plate	M	8223			Unlacquered Brass (US3NL)*	\$275	\$475

*Unlacquered Brass (US3NL) finish available for a \$20 List Price upcharge per item.

**SELECT knobsets/leversets may be ordered with any Brass Thumbturn privacy at a higher list price. See SELECT Brass Sideplate Lockset page for pricing.

• **Handing Required for Leversets**

- Standard 2 1/8" door prep. Standard latch is for 2 3/8" backset. Specify 2 3/4" backset if required.
- Thumbturn privacy bolt can be used with any Brass passage set.
- Supplied with standard rotation latch. To order 28° Rotation latch, add product code **Latch28** and list price \$7
- Thumbturn privacy bolt only available with square corner latch face plate.

For more information
• See pages 130-131 for Interior Mortise (M)

STRETTO uses a tubular latch and is available for order in passage, thumb-turn privacy, keyed entry and dummy functions. It can be paired with any Emtek knob or lever. The sleek design of the **STRETTO** requires a 1 1/4" diameter bore hole and a 2-hole door preparation for privacy thumb-turn and keyed configurations. Additional specifications for this truly unique design include:

- Supplied with a 28° rotation latch for Leversets, standard rotation latch for Knobsets.
- Available in 2 3/8" or 2 3/4" backset

STRETTO NON-KEYED PASSAGE STYLES

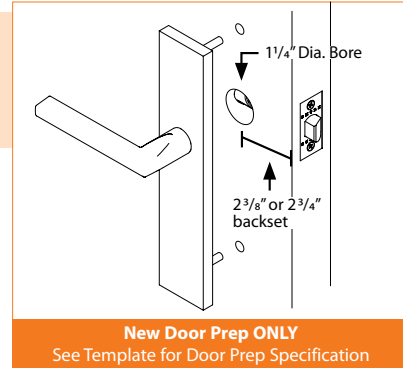
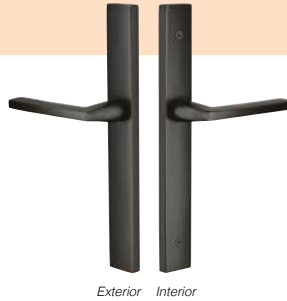

• Narrow 1 1/4" Door Prep

STRETTO THUMBTURN PRIVACY STYLES

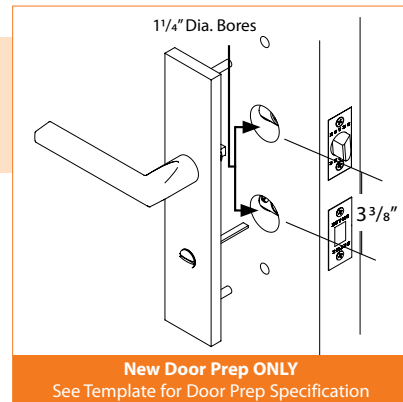

• Narrow 1 1/4" Door Prep, 3 3/8" Center-to-Center Hole Spacing
• Privacy Thumbturn

STRETTO DUMMY PAIR STYLES

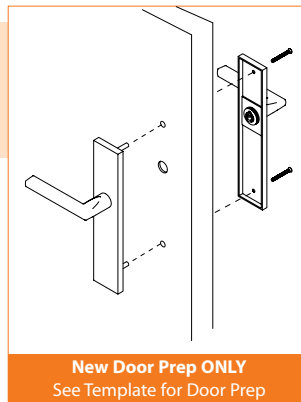

STRETTO DUMMY SINGLE SIDED STYLES

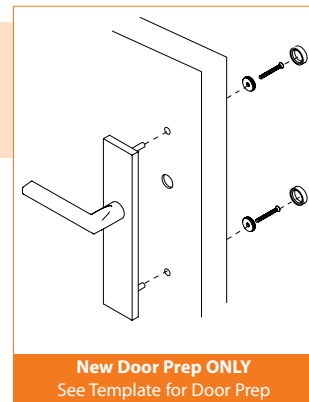

STRETTO KEYED ENTRY STYLES

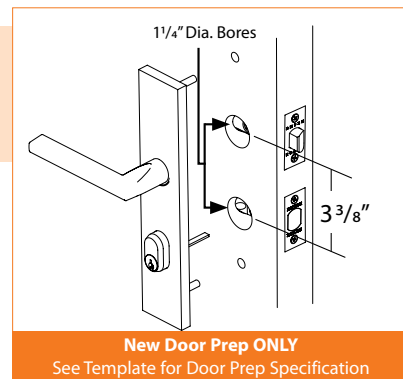

• Narrow 1 1/4" Door Prep, 3 3/8" Center-to-Center Hole Spacing
• Schlage® C Keyway (Available in Weiser® Keyway)

STRETTO NARROW TRIM LOCKSETS - BRASS TUBULAR

10" STRETTO
Thumbturn Privacy Set

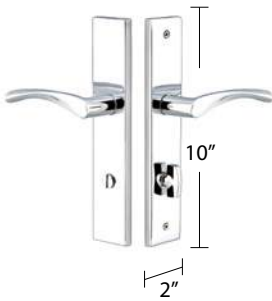

2" x 10" MODERN RECTANGULAR NON-KEYED	Product Code	Knob or Lever Style	Finish	List Price
Passage	8141	See Pages 10-23 for Brass Knob & Lever Options.	Satin Brass (US4)	\$275
Thumbturn Privacy	8241		Oil Rubbed Bronze (US10B)	\$275
Dummy, Pair	8045		Polished Nickel - Lifetime (US14)	\$275
Dummy, Single Sided	8041		Satin Nickel (US15)	\$138
			Flat Black (US19)	
			Polished Chrome (US26)	
			Unlacquered Brass (US3NL)*	

10" STRETTO
Keyed Entry Set



2" x 10" MODERN RECTANGULAR KEYED	Product Code	Knob or Lever Style	Finish	List Price
Single Cylinder	8442	See Pages 10-23 for Brass Knob & Lever Options.	Satin Brass (US4)	\$315
Dummy, Pair	8042		Oil Rubbed Bronze (US10B)	\$315
			Polished Nickel - Lifetime (US14)	
			Satin Nickel (US15)	
			Flat Black (US19)	
			Polished Chrome (US26)	
			Unlacquered Brass (US3NL)*	

11" STRETTO
Non-Keyed Passage Set

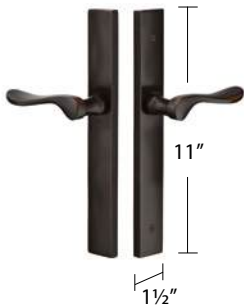

1 1/2" x 11" MODERN RECTANGULAR NON-KEYED	Product Code	Knob or Lever Style	Finish	List Price
Passage	8143	See Pages 10-23 for Brass Knob & Lever Options.	Satin Brass (US4)	\$275
Thumbturn Privacy	8243		Oil Rubbed Bronze (US10B)	\$275
Dummy, Pair	8046		Polished Nickel - Lifetime (US14)	\$275
Dummy, Single Sided	8043		Satin Nickel (US15)	\$138
			Flat Black (US19)	
			Polished Chrome (US26)	
			Unlacquered Brass (US3NL)*	

11" STRETTO
Keyed Entry Set



1 1/2" x 11" MODERN RECTANGULAR KEYED	Product Code	Knob or Lever Style	Finish	List Price
Single Cylinder	8444	See Pages 10-23 for Brass Knob & Lever Options.	Satin Brass (US4)	\$315
Dummy, Pair	8044		Oil Rubbed Bronze (US10B)	\$315
			Polished Nickel - Lifetime (US14)	
			Satin Nickel (US15)	
			Flat Black (US19)	
			Polished Chrome (US26)	
			Unlacquered Brass (US3NL)*	

*Unlacquered Brass (US3NL) finish available for a \$20 List Price upcharge per item.

• Handing Required for Leversets

- Supplied with a 28° rotation latch for Leversets, standard rotation latch for Knobsets.
- Standard backset is 2 3/8". Specify 2 3/4" backset if required.
- Thumbturn privacy bolt only available with square corner latch face plate.

Weiser® (WR5) Keyway

- Specify by adding "W" to the beginning of product code.
- No upcharge for cylinder substitution. Can be keyed into existing Weiser® system.

10½" STRETTO
Non-Keyed Passage Set



2" x 10½" CONCORD NON-KEYED	Product Code	Knob or Lever Style	Finish	List Price
Passage	7141	See Pages 10-23 for Brass Knob & Lever Options.	Polished Brass - Lifetime (US3) French Antique (US7) Oil Rubbed Bronze (US10B) Polished Nickel - Lifetime (US14) Satin Nickel (US15) Pewter (US15A) Flat Black (US19) Polished Chrome (US26) Unlacquered Brass (US3NL)*	\$275
Thumbturn Privacy	7241			\$275
Dummy, Pair	7045			\$275
Dummy, Single Sided	7041			\$138

10½" STRETTO
Keyed Entry Set



2" x 10½" CONCORD KEYED	Product Code	Knob or Lever Style	Finish	List Price
Single Cylinder	7442	See Pages 10-23 for Brass Knob & Lever Options.	Polished Brass - Lifetime (US3) French Antique (US7) Oil Rubbed Bronze (US10B) Polished Nickel - Lifetime (US14) Satin Nickel (US15) Pewter (US15A) Flat Black (US19) Polished Chrome (US26) Unlacquered Brass (US3NL)*	\$315
Dummy, Pair	7042			\$315

11" STRETTO
Thumbturn Privacy Set



1½" x 11" CONCORD NON-KEYED	Product Code	Knob or Lever Style	Finish	List Price
Passage	7143	See Pages 10-23 for Brass Knob & Lever Options.	Polished Brass - Lifetime (US3) French Antique (US7) Oil Rubbed Bronze (US10B) Polished Nickel - Lifetime (US14) Satin Nickel (US15) Pewter (US15A) Flat Black (US19) Polished Chrome (US26) Unlacquered Brass (US3NL)*	\$275
Thumbturn Privacy	7243			\$275
Dummy, Pair	7046			\$275
Dummy, Single Sided	7043			\$138

11" STRETTO
Keyed Entry Set



1½" x 11" CONCORD KEYED	Product Code	Knob or Lever Style	Finish	List Price
Single Cylinder	7444	See Pages 10-23 for Brass Knob & Lever Options.	Polished Brass - Lifetime (US3) French Antique (US7) Oil Rubbed Bronze (US10B) Polished Nickel - Lifetime (US14) Satin Nickel (US15) Pewter (US15A) Flat Black (US19) Polished Chrome (US26) Unlacquered Brass (US3NL)*	\$315
Dummy, Pair	7044			\$315

*Unlacquered Brass (US3NL) finish available for a \$20 List Price upcharge per item.

• **Handing Required for Leversets**

- Supplied with a 28° rotation latch for Leversets, standard rotation latch for Knobsets.
- Standard backset is 2¾". Specify 2¾" backset if required.
- Thumbturn privacy bolt only available with square corner latch face plate.

Weiser® (WR5) Keyway

- Specify by adding "W" to the beginning of product code.
- No upcharge for cylinder substitution. Can be keyed into existing Weiser® system.

To order: (W) Product Code + Knob/Lever Style + Handing + Finish + Add Door Thickness to Comments

STRETTO NARROW TRIM LOCKSETS - SANDCAST BRONZE TUBULAR

10" STRETTO
Non-Keyed Passage Set

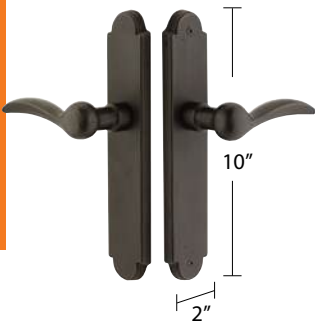

2" x 10" ARCHED NON-KEYED	Product Code	Knob or Lever Style	Finish	List Price
Passage	4141	See Pages 24-25 for Sandcast Bronze Knob & Lever Options.	Flat Black Bronze (FB) Medium Bronze (MB) Tumbled White Bronze (TWB)	\$308
Thumbturn Privacy	4241			\$308
Dummy, Pair	4045			\$308
Dummy, Single Sided	4041			\$153

10" STRETTO
Keyed Entry Set



2" x 10" ARCHED KEYED	Product Code	Knob or Lever Style	Finish	List Price
Single Cylinder	4442	See Pages 24-25 for Sandcast Bronze Knob & Lever Options.	Flat Black Bronze (FB) Medium Bronze (MB) Tumbled White Bronze (TWB)	\$356
Dummy, Pair	4042			\$356

11" STRETTO
Thumbturn Privacy Set

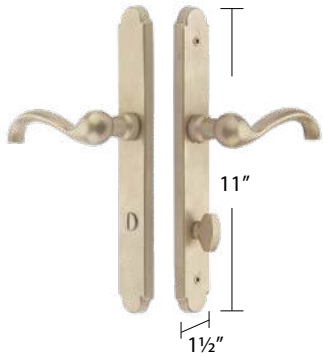

1 1/2" x 11" ARCHED NON-KEYED	Product Code	Knob or Lever Style	Finish	List Price
Passage	4143	See Pages 24-25 for Sandcast Bronze Knob & Lever Options.	Flat Black Bronze (FB) Medium Bronze (MB) Tumbled White Bronze (TWB)	\$308
Thumbturn Privacy	4243			\$308
Dummy, Pair	4046			\$308
Dummy, Single Sided	4043			\$153

11" STRETTO
Keyed Entry Set



1 1/2" x 11" ARCHED KEYED	Product Code	Knob or Lever Style	Finish	List Price
Single Cylinder	4444	See Pages 24-25 for Sandcast Bronze Knob & Lever Options.	Flat Black Bronze (FB) Medium Bronze (MB) Tumbled White Bronze (TWB)	\$356
Dummy, Pair	4044			\$356

• Handing Required for Leversets

- Supplied with a 28° rotation latch for Leversets, standard rotation latch for Knobsets.
- Standard backset is 2 3/8". Specify 2 3/4" backset if required.
- Thumbturn privacy bolt only available with square corner latch face plate.

Weiser® (WR5) Keyway

- Specify by adding "W" to the beginning of product code.
- No upcharge for cylinder substitution. Can be keyed into existing Weiser® system.

10" STRETTO
Thumbturn Privacy Set

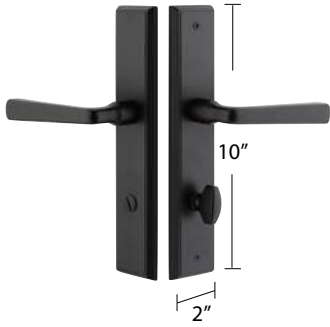

2" x 10" RECTANGULAR NON-KEYED	Product Code	Knob or Lever Style	Finish	List Price
Passage	5141	See Pages 24-25 for Sandcast Bronze Knob & Lever Options.	Flat Black Bronze (FB) Medium Bronze (MB) Tumbled White Bronze (TWB)	\$308
Thumbturn Privacy	5241			\$308
Dummy, Pair	5045			\$308
Dummy, Single Sided	5041			\$153

10" STRETTO
Keyed Entry Set



2" x 10" RECTANGULAR KEYED	Product Code	Knob or Lever Style	Finish	List Price
Single Cylinder	5442	See Pages 24-25 for Sandcast Bronze Knob & Lever Options.	Flat Black Bronze (FB) Medium Bronze (MB) Tumbled White Bronze (TWB)	\$356
Dummy, Pair	5042			\$356

11" STRETTO
Non-Keyed Passage Set



1 1/2" x 11" RECTANGULAR NON-KEYED	Product Code	Knob or Lever Style	Finish	List Price
Passage	5143	See Pages 24-25 for Sandcast Bronze Knob & Lever Options.	Flat Black Bronze (FB) Medium Bronze (MB) Tumbled White Bronze (TWB)	\$308
Thumbturn Privacy	5243			\$308
Dummy, Pair	5046			\$308
Dummy, Single Sided	5043			\$153

11" STRETTO
Keyed Entry Set



1 1/2" x 11" RECTANGULAR KEYED	Product Code	Knob or Lever Style	Finish	List Price
Single Cylinder	5444	See Pages 24-25 for Sandcast Bronze Knob & Lever Options.	Flat Black Bronze (FB) Medium Bronze (MB) Tumbled White Bronze (TWB)	\$356
Dummy, Pair	5044			\$356

• **Handing Required for Leversets**

- Supplied with a 28° rotation latch for Leversets, standard rotation latch for Knobsets.
- Standard backset is 2 3/8". Specify 2 3/4" backset if required.
- Thumbturn privacy bolt only available with square corner latch face plate.

Weiser® (WR5) Keyway

- Specify by adding "W" to the beginning of product code.
- No upcharge for cylinder substitution. Can be keyed into existing Weiser® system.

To order: (W) Product Code + Knob/Lever Style + Handing + Finish + Add Door Thickness to Comments

STRETTO NARROW TRIM LOCKSETS - TUSCANY BRONZE TUBULAR

10½" STRETTO
Non-Keyed Passage Set

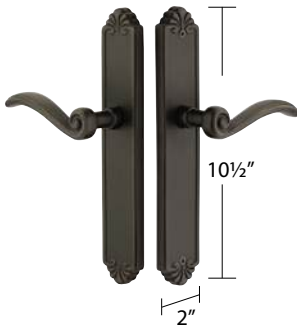

2" x 10½" TUSCANY NON-KEYED	Product Code	Knob or Lever Style	Finish	List Price
Passage	6141	See Pages 24-25 for Tuscany Bronze Knob & Lever Options.	Flat Black Bronze (FB) Medium Bronze (MB)	\$308
Thumbturn Privacy	6241			\$308
Dummy, Pair	6045			\$308
Dummy, Single Sided	6041			\$153

10½" STRETTO
Keyed Entry Set



2" x 10½" TUSCANY KEYED	Product Code	Knob or Lever Style	Finish	List Price
Single Cylinder	6442	See Pages 24-25 for Tuscany Bronze Knob & Lever Options.	Flat Black Bronze (FB) Medium Bronze (MB)	\$356
Dummy, Pair	6042			\$356

11¼" STRETTO
Thumbturn Privacy Set

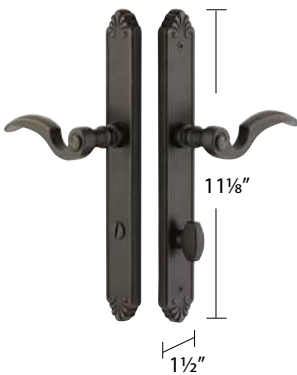

1½" x 11¼" TUSCANY NON-KEYED	Product Code	Knob or Lever Style	Finish	List Price
Passage	6143	See Pages 24-25 for Tuscany Bronze Knob & Lever Options.	Flat Black Bronze (FB) Medium Bronze (MB)	\$308
Thumbturn Privacy	6243			\$308
Dummy, Pair	6046			\$308
Dummy, Single Sided	6043			\$153

11¼" STRETTO
Keyed Entry Set



1½" x 11¼" TUSCANY KEYED	Product Code	Knob or Lever Style	Finish	List Price
Single Cylinder	6444	See Pages 24-25 for Tuscany Bronze Knob & Lever Options.	Flat Black Bronze (FB) Medium Bronze (MB)	\$356
Dummy, Pair	6044			\$356

• Handing Required for Leversets

- Supplied with a 28° rotation latch for Leversets, standard rotation latch for Knobsets.
- Standard backset is 2¾". Specify 2¾" backset if required.
- Thumbturn privacy bolt only available with square corner latch face plate.

Weiser® (WR5) Keyway

- Specify by adding "W" to the beginning of product code.
- No upcharge for cylinder substitution. Can be keyed into existing Weiser® system.

10" STRETTO
Thumbturn Privacy Set

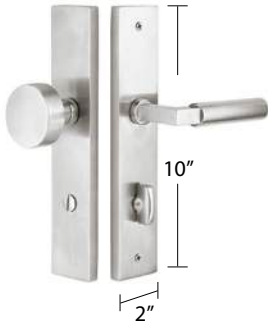

2" x 10" STAINLESS STEEL NON-KEYED	Product Code	Knob or Lever Style	Finish	List Price
Passage	9141	See Pages 26-27 for Stainless Steel Knob & Lever Options.	Brushed Stainless Steel (SS)	\$275
Thumbturn Privacy	9241			\$275
Dummy, Pair	9045			\$275
Dummy, Single Sided	9041			\$138

10" STRETTO
Keyed Entry Set



2" x 10" STAINLESS STEEL KEYED	Product Code	Knob or Lever Style	Finish	List Price
Single Cylinder	9442	See Pages 26-27 for Stainless Steel Knob & Lever Options.	Brushed Stainless Steel (SS)	\$315
Dummy, Pair	9042			\$315

11" STRETTO
Non-Keyed Passage Set

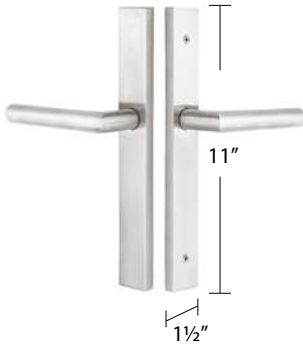

1 1/2" x 11" STAINLESS STEEL NON-KEYED	Product Code	Knob or Lever Style	Finish	List Price
Passage	9143	See Pages 26-27 for Stainless Steel Knob & Lever Options.	Brushed Stainless Steel (SS)	\$275
Thumbturn Privacy	9243			\$275
Dummy, Pair	9046			\$275
Dummy, Single Sided	9043			\$138

11" STRETTO
Keyed Entry Set



1 1/2" x 11" STAINLESS STEEL KEYED	Product Code	Knob or Lever Style	Finish	List Price
Single Cylinder	9444	See Pages 26-27 for Stainless Steel Knob & Lever Options.	Brushed Stainless Steel (SS)	\$315
Dummy, Pair	9044			\$315

• Handing Required for Leversets

- Supplied with a 28° rotation latch for Leversets, standard rotation latch for Knobsets.
- Standard backset is 2 3/8". Specify 2 3/4" backset if required.
- Thumbturn privacy bolt only available with square corner latch face plate.

Weiser® (WR5) Keyway

- Specify by adding "W" to the beginning of product code.
- No upcharge for cylinder substitution. Can be keyed into existing Weiser® system.

To order: (W) Product Code + Knob/Lever Style + Handing + Finish + Add Door Thickness to Comments



EMTEK SELECT



Passage



Passage with Thumbturn Privacy

IMPORTANT DOOR PREP INFORMATION

New Door Prep Only

- Cannot be combined with other rosette designs on opposite side of the door.
- Handing is required for Knob by Lever and split finish products.

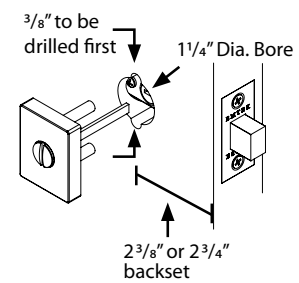
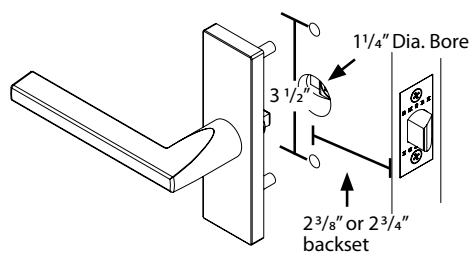
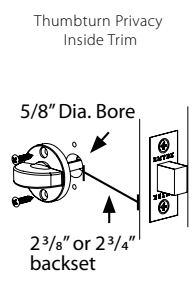
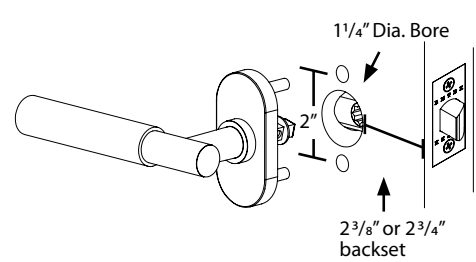





























1½" x 3" OVAL STRETTO
with T-Bar Straight Knurled Levers



1½" x 5" MODERN RECTANGULAR STRETTO
with L-Square Straight Knurled Levers



ROSETTE	Product Code	STEM	HANDLE/KNOB	List Price		
OVAL STRETTO ROSETTE						
Passage	5801	 L-SQUARE (LS)	 FACETED (FA)	\$254		
Thumbturn Privacy	5802		 KNURLED (KN)	\$254		
Dummy, Pair	5803		 HAMMERED (HA)	 SMOOTH (SM)	\$254	
Dummy, Single Sided	5804		 T-BAR (TA)	 STRAIGHT KNURLED (SK)	\$146	
			 TRIBECA (TR)			
			 WHITE MARBLE (MRWH)			
			 GREEN MARBLE (MRGN)			
			 ROSSO LEVANTO MARBLE (MRRD)			
			 LIGHT TERRAZZO (TZLT)			
			 DARK WALNUT (WNWD)			
MODERN RECTANGULAR STRETTO ROSETTE						
Passage	5507	 R-BAR (RA)		\$254		
Thumbturn Privacy	5607			\$254		
Dummy, Pair	5007			\$254		
Dummy, Single Sided	5005		 CONICAL (CC)	 KNURLED (KNK)	\$146	
			 STRAIGHT KNURLED (SKK)			
			 LIGHT TERRAZZO (TZKLT)			
			 WHITE MARBLE (MRKWH)			
			 GREEN MARBLE (MRKGN)			
			 DARK WALNUT (WKNWD)			
			 ROSSO LEVANTO MARBLE (MRKRD)			
Finish options for ROSETTE, STEM and HANDLE/KNOB			STEM AND HANDLE/KNOB WILL BE PERMANENTLY AFFIXED.			
						
Satin Brass (US4)	Oil Rubbed Bronze (US10B)	Polished Nickel - Lifetime (US14)	Satin Nickel (US15)	Flat Black (US19)	Polished Chrome (US26)	Unlacquered Brass (US3NL)*

>> Emtek SELECT Lever and Knob(s) with Marble, Terrazzo and Walnut handles feature a living finish that will age gracefully and evolve over time, enhancing the character of your space. Due to this unique characteristic, no finish warranty is offered on these products. All SELECT lever and knobs featuring Marble, Terrazzo and Walnut are intended for indoor use.

• **Handing Required for Leversets**

- Requires a 1¼" diameter bore hole and 2-hole door preparation for thumbturn privacy bolt.
- Standard backset is 2¾". Specify 2¾" backset if required. Complete set includes latch and strike plate.
- Thumbturn privacy bolt only available with square corner latch face plate.
- Supplied with a 28° rotation latch for Leversets, standard rotation latch for Knobsets.
- SELECT knobsets/leversets may also be ordered with any Brass STRETTO at the list price shown above.

*Unlacquered Brass (US3NL) finish available for a \$20 List Price upcharge per item.

To order: Rosette/Finish . Stem/Finish . Handle or Knob/Finish . Handing + Add Door Thickness to Comments

STRETTO NARROW TRIM LOCKSETS - BRASS PASSAGE & PRIVACY

1½" x 3" OVAL STRETTO
with Myles Levers
Passage Set



1½" x 3" OVAL STRETTO
with Stuttgart Levers
Thumbturn Privacy Set



1½" x 3" OVAL STRETTO
with Modern Disc Glass Knobs
Dummy Set



1½" x 3" OVAL STRETTO
with Round Knobs
Passage Set



1½" x 3" OVAL STRETTO
with Orb Knobs
Thumbturn Privacy Set



<< Includes Single Disk Rosette and Arched Thumbturn Privacy Bolt.

OVAL STRETTO	Product Code	Knob or Lever Style	Finish	List Price
Passage	5801	See Pages 10-23 for Brass Knob & Lever Options**	Satin Brass (US4)	\$218
Thumbturn Privacy	5802		Oil Rubbed Bronze (US10B)	\$218
Dummy, Pair	5803		Polished Nickel - Lifetime (US14)	\$218
Dummy, Single Sided	5804		Satin Nickel (US15)	\$110
			Flat Black (US19)	
			Polished Chrome (US26)	
			Unlacquered Brass (US3NL)*	

*Unlacquered Brass (US3NL) finish available for a \$20 List Price upcharge per item.

**SELECT knobsets/leversets may be ordered with any Brass STRETTO at a higher list price. See SELECT Brass STRETTO Lockset page for pricing.

- **Handing Required for Leversets**
- Requires a 1¼" diameter bore hole and 2-hole door preparation for thumbturn privacy bolt.
- Standard backset is 2¾". Specify 2¾" backset if required. Complete set includes latch and strike plate.
- Thumbturn privacy bolt only available with square corner latch face plate.
- Supplied with a 28° rotation latch for Leversets, standard rotation latch for Knobsets.

1½" x 5" MODERN RECTANGULAR STRETTO
with Helios Levers
Passage Set



1½" x 5" MODERN RECTANGULAR STRETTO
with Hercules Levers
Privacy Set



1½" x 5" MODERN RECTANGULAR STRETTO
with Modern Disc Glass Knobs
Dummy Set



1½" x 5" MODERN RECTANGULAR STRETTO
with Modern Square Glass Knobs
Passage Set



1½" x 5" MODERN RECTANGULAR STRETTO
with Round Knobs
Privacy Set



<< Thumbturn privacy bolt can be purchased separately.

MODERN RECTANGULAR STRETTO	Product Code	Knob or Lever Style	Finish	List Price
Passage	5507	See Pages 10-23 for Brass Knob & Lever Options**	Satin Brass (US4)	\$218
Thumbturn Privacy	5607		Oil Rubbed Bronze (US10B)	\$218
Dummy, Pair	5007		Polished Nickel - Lifetime (US14)	\$218
Dummy, Single Sided	5005		Satin Nickel (US15)	\$110
			Flat Black (US19)	
			Polished Chrome (US26)	
			Unlacquered Brass (US3NL)*	

*Unlacquered Brass (US3NL) finish available for a \$20 List Price upcharge per item.

**SELECT knobsets/leversets may be ordered with any Brass STRETTO at a higher list price. See SELECT Brass STRETTO Lockset page for pricing.

• Handing Required for Leversets

- Requires a 1¼" diameter bore hole and 2-hole door preparation for thumbturn privacy bolt.
- Standard backset is 2¾". Specify 2¾" backset if required. Complete set includes latch and strike plate.
- Thumbturn privacy bolt only available with square corner latch face plate.
- Supplied with a 28° rotation latch for Leversets, standard rotation latch for Knobsets.

INTERIOR MORTISE LOCK WITH MAGNETIC LATCH

Luxurious Solution for High-End and Custom Door Applications



Minimal Design



Magnetic Latch



Sleek Strike Plate

Magnetic Latch Mechanism - Ensures a smooth and silent operation by reducing friction when door closes, providing a superior experience compared to traditional latches, and limiting wear on the closure

Low Profile Design - Streamlined, non-exposed latch bolt and non-lipped strike plate sit flush with the door edge, creating a seamless, unobtrusive look, perfect for hidden doors or modern and minimalist designs

Durable, Solid Construction - Engineered with precision for a secure and stable fit, enhancing durability for long-lasting performance with minimal maintenance

Interconnected Lock Function - Allows latch and deadbolt to retract simultaneously when opened from the inside without using thumb-turn, offering convenience and ease of operation

Versatile Use - Designed to accommodate doors measuring 1 $\frac{3}{4}$ " thick and up, for a wide range of premium and custom interior door applications

Independent Lever Adjustment - Each side can be adjusted independent of the other, allowing fine tune adjustments on lever heights for precise positioning on the door

Wide Variety of Finish & Trim Options - Compatible with Emtek knobs, levers, rosettes, and thumb-turn sideplates, providing design flexibility to achieve a cohesive look throughout the space

To order: **M** **5109US19 . TAUS3NL . FAUS26 . RH** + Add Door Thickness to Comments

Interior Mortise
Optional Upgrade

Rosette (Function/Finish)	+	Stem (Style/Finish)	+	Handle (Style/Finish)	+	Handing (RH or LH)
------------------------------	---	------------------------	---	--------------------------	---	-----------------------

- Handing Required for Leversets & Knobsets
- Available only in a 2 $\frac{1}{2}$ " backset

PRE-CONFIGURED THUMBTURN PRIVACY DOUBLE ROSETTES



Disk





















Square



Watford



Wilshire

	Disk Rosette	•			
	Square Rosette		•		
	Modern Rectangular Rosette		•		
	Modern Rosette	•			
	Neos Rosette		•		
	Urban Modern Rosette	•			
	Quincy Rosette		•		
	Watford Rosette			•	
	Wilshire Rosette				•
	#8 Rosette		•		
	Oval Rosette		•		
	Rectangular Rosette				•
	Regular Rosette			•	
	Rope Rosette			•	
	Lancaster Rosette			•	
	Ribbon & Reed Rosette			•	
	Arts & Crafts Rosette		•		
	Hammered Rosette		•		



EMTEK SELECT Levers
Mix-Match Style & Finish
for handles, stems and rosettes

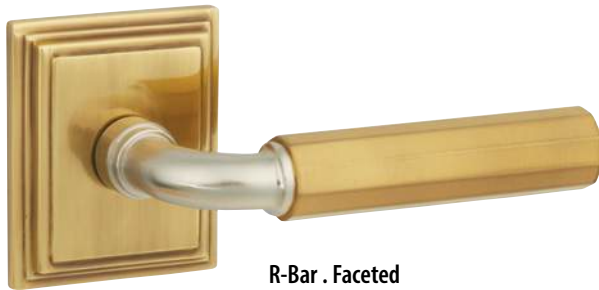

R-Bar . Faceted
with Wilshire Rosette
8161US7.RAUS15.FAUS7.RH



T-Bar . Knurled
with Modern Rectangular Rosette
5112US15.TAUS4.KNUS15.RH



R-Bar . Hammered
with Watford Rosette
8110US3NL.RAUS26.HAUS3NL.RH



R-Bar . Straight Knurled
with Disk Rosette
5109US26.RAUS3NL.SKUS26.RH



T-Bar . Hammered
with Square Rosette
5110US14.TAUS14.HAUS14.RH

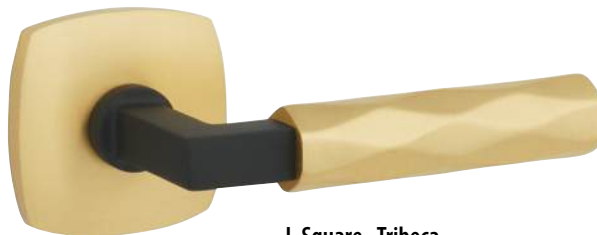













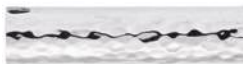













L-Square . Tribeca
with Urban Modern Rosette
5316US4.LSUS19.TRUS4.RH

To order: **CorM** 5109US19 . TAUS3NL . FAUS26 . RH + Add Door Thickness to Comments

Optional Upgrade Rosette (Function/Finish) + Stem (Style/Finish) + Handle (Style/Finish) + Handing (RH or LH)

Concealed Fastener = C
Interior Mortise = M

ROSETTE	Description	Optional Upgrade	Product Code	STEM	HANDLE	Standard List Price	C List Price	M List Price						
	Passage Set	C or M	5109	 L-SQUARE (LS)	 FACETED (FA)	\$246	\$290	\$446						
	Privacy Set	C or M	5209			\$246	\$290	\$446						
	Dummy		5059			\$246								
	Passage Set	C or M	5110		 T-BAR (TA)	 HAMMERED (HA)	\$246	\$290	\$446					
	Privacy Set	C or M	5210				\$246	\$290	\$446					
	Dummy		5050				\$246							
	Passage Set	C or M	5112			 R-BAR (RA)	 KNURLED (KN)	\$246	\$290	\$446				
	Privacy Set	C or M	5212					\$246	\$290	\$446				
	Dummy		5052					\$246						
	Passage Set	C or M	5316				 SMOOTH (SM)	 STRAIGHT KNURLED (SK)	\$246	\$290	\$446			
	Privacy Set	C or M	5326						\$246	\$290	\$446			
	Dummy		5306						\$246					
	Passage Set	C or M	8131					 TRIBECA (TR)	 TRIBECA (TR)	\$246	\$290	\$446		
	Privacy Set	C or M	8231							\$246	\$290	\$446		
	Dummy		8531							\$246				
	Passage Set	C or M	8110							\$246	\$290	\$446		
	Privacy Set	C or M	8210							\$246	\$290	\$446		
	Dummy		8510							\$246				
	Passage Set	C or M	8161							\$246	\$290	\$446		
	Privacy Set	C or M	8261							\$246	\$290	\$446		
	Dummy		8561							\$246				
Finish options for ROSETTE, STEM and HANDLE						STEM AND HANDLE WILL BE PERMANENTLY AFFIXED.								
														
Satin Brass (US4)	French Antique (US7)	Oil Rubbed Bronze (US10B)	Polished Nickel - Lifetime (US14)			Satin Nickel (US15)			Pewter (US15A)**	Flat Black (US19)	Polished Chrome (US26)	Matte White (MW)**	Satin Rose Gold (SRG)**	Unlacquered Brass (US3NL)*

*Unlacquered Brass (US3NL) finish available for a \$20 List Price upcharge per item.

** Finish NOT available for Faceted, Hammered and Tribeca Handles.

** Finish NOT available for Interior Mortise.

• **Handing Required for Leversets**

- Supplied with a 28° rotation latch.
- Standard latch is for 2 3/8" backset. Specify 2 3/4" backset if required.
- Complete set includes latch, strike plate and dust box. Specify Drive-in latch if required.
- Latches come standard with square corner strike and face plates. Specify radius corners if required.
- SELECT Leversets may also be ordered with any Brass rosette at the list price shown above.

For more information

- See page 170 for Concealed Fastener (C)
- See pages 130-131 for Interior Mortise (M)

To order: (Optional Upgrade) Rosette/Finish . Stem/Finish . Handle/Finish . Handing + Add Door Thickness to Comments



EMTEK SELECT Levers
Mix-Match Style & Finish
for handles, stems and rosettes



R-Bar . Green Marble
with Urban Modern Rosette
5316US26.RAUS26.MRGN.RH



L-Square . White Marble
with Wilshire Rosette
8161US3NL.LSUS3NL.MRWH.RH

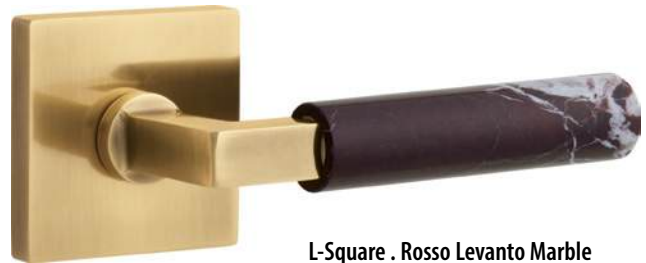

L-Square . Rosso Levanto Marble
with Square Rosette
5110US7.LSUS7.MRRD.RH



R-Bar . Dark Walnut
with Watford Rosette
8110US14.RAUS14.WNWD.RH





























T-Bar . Light Terrazzo
with Disk Rosette
5109US19.TAUS3NL.TZLT.RH

To order: **C or M** 5109US19 . TAUS3NL . TZLT . RH + Add Door Thickness to Comments

Optional Upgrade Rosette (Function/Finish) + Stem (Style/Finish) + Handle (Style/Finish) + Handing (RH or LH)

Concealed Fastener = C
Interior Mortise = M

ROSETTE	Description	Optional Upgrade	Product Code	STEM	HANDLE	Standard List Price	C List Price	M List Price				
	Passage Set	C or M	5109	 L-SQUARE (LS)	 DARK WALNUT (WNWD)	\$246	\$290	\$446				
	Privacy Set	C or M	5209			\$246	\$290	\$446				
	Dummy		5059			\$246						
	Passage Set	C or M	5110			 GREEN MARBLE (MRGN)	\$246	\$290	\$446			
	Privacy Set	C or M	5210				\$246	\$290	\$446			
	Dummy		5050				\$246					
	Passage Set	C or M	5112		 LIGHT TERRAZZO (TZLT)		\$246	\$290	\$446			
	Privacy Set	C or M	5212				\$246	\$290	\$446			
	Dummy		5052				\$246					
	Passage Set	C or M	5316			 T-BAR (TA)	 ROSSO LEVANTO MARBLE (MRRD)	\$246	\$290	\$446		
	Privacy Set	C or M	5326					\$246	\$290	\$446		
	Dummy		5306					\$246				
	Passage Set	C or M	8131	 R-BAR (RA)	 WHITE MARBLE (MRWH)			\$246	\$290	\$446		
	Privacy Set	C or M	8231					\$246	\$290	\$446		
	Dummy		8531					\$246				
	Passage Set	C or M	8110					\$246	\$290	\$446		
	Privacy Set	C or M	8210					\$246	\$290	\$446		
	Dummy		8510					\$246				
	Passage Set	C or M	8161					\$246	\$290	\$446		
	Privacy Set	C or M	8261					\$246	\$290	\$446		
	Dummy		8561					\$246				
Finish options for ROSETTE, STEM and HANDLE						STEM AND HANDLE WILL BE PERMANENTLY AFFIXED.						
												
Satin Brass (US4)	French Antique (US7)	Oil Rubbed Bronze (US10B)	Polished Nickel - Lifetime (US14)			Satin Nickel (US15)	Pewter (US15A)	Flat Black (US19)	Polished Chrome (US26)	Matte White (MW)	Satin Rose Gold (SRG)	Unlacquered Brass (US3NL)*

*Unlacquered Brass (US3NL) finish available for a \$20 List Price upcharge per item.

>> Etek SELECT Lever and Knob(s) with Marble, Terrazzo and Walnut handles feature a living finish that will age gracefully and evolve over time, enhancing the character of your space. Due to this unique characteristic, no finish warranty is offered on these products. All SELECT lever and knobs featuring Marble, Terrazzo and Walnut are intended for indoor use.

• **Handing Required for Leversets**

- Supplied with a 28° rotation latch.
- Standard latch is for 2 3/8" backset. Specify 2 3/4" backset if required.
- Complete set includes latch, strike plate and dust box. Specify Drive-in latch if required.
- Latches come standard with square corner strike and face plates. Specify radius corners if required.
- SELECT Leversets may also be ordered with any Brass rosette at the list price shown above.

For more information

- See page 170 for Concealed Fastener (C)
- See pages 130-131 for Interior Mortise (M)

To order: (Optional Upgrade) Rosette/Finish . Stem/Finish . Handle/Finish . Handing + Add Door Thickness to Comments



EMTEK SELECT Knobs
Mix-Match Style & Finish
for knobs, stem and rosettes

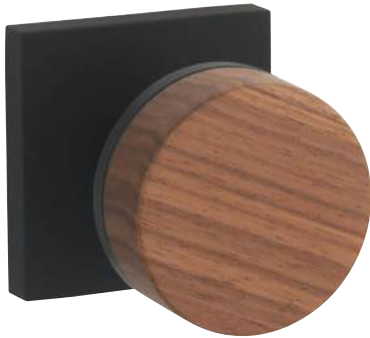

Conical . Dark Walnut
with Square Rosette
5110US19.CCUS19.WNKWD



Conical . Rosso Levante
with Wilshire Rosette
8161US3NL.CCUS3NL.MRKRD



Conical . Light Terrazzo
with Modern Rectangular Rosette
5112US15.CCUS4.TZKLT



Conical . Knurled
with Watford Rosette
8110US14.CCUS4.KNKUS4



Conical . White Marble
with Disk Rosette
5109US26.CCUS3NL.MRKWH



Conical . Straight Knurled
with Urban Modern Rosette
5316US19.CCUS19.SKKUS19

















Conical . Green Marble
with Watford Rosette
8110US14.CCUS14.MRKGN

To order: **Cor M** 5109US19 . CCUS4 . SKKUS4 + Add Door Thickness to Comments

Optional Upgrade Rosette (Function/Finish) + Stem (Style/Finish) + Knob (Style/Finish)

Concealed Fastener = C
Interior Mortise = M

ROSETTE	Description	Optional Upgrade	Product Code	STEM	KNOB	Standard List Price	C List Price	M List Price				
	Passage Set	C or M	5109			\$246	\$290	\$446				
	Privacy Set	C or M	5209			\$246	\$290	\$446				
	Dummy		5059			\$246						
	Passage Set	C or M	5110			\$246	\$290	\$446				
	Privacy Set	C or M	5210			\$246	\$290	\$446				
	Dummy		5050			\$246						
	Passage Set	C or M	5112				\$246	\$290	\$446			
	Privacy Set	C or M	5212				\$246	\$290	\$446			
	Dummy		5052				\$246					
	Passage Set	C or M	5316					\$246	\$290	\$446		
	Privacy Set	C or M	5326					\$246	\$290	\$446		
	Dummy		5306					\$246				
	Passage Set	C or M	8131						\$246	\$290	\$446	
	Privacy Set	C or M	8231						\$246	\$290	\$446	
	Dummy		8531						\$246			
	Passage Set	C or M	8110							\$246	\$290	\$446
	Privacy Set	C or M	8210							\$246	\$290	\$446
	Dummy		8510							\$246		
	Passage Set	C or M	8161							\$246	\$290	\$446
	Privacy Set	C or M	8261							\$246	\$290	\$446
	Dummy		8561							\$246		

Finish options for ROSETTE, STEM and KNOB

STEM AND KNOB WILL BE PERMANENTLY AFFIXED.

										
Satin Brass (US4)	French Antique (US7)	Oil Rubbed Bronze (US10B)	Polished Nickel - Lifetime (US14)	Satin Nickel (US15)	Pewter (US15A)**	Flat Black (US19)	Polished Chrome (US26)	Matte White (MW)**	Satin Rose Gold (SRG)**	Unlacquered Brass (US3NL)*

*Unlacquered Brass (US3NL) finish available for a \$20 List Price upcharge per item.

** Finish NOT available for Conical Stem, Knurled and Straight Knurled Knobs.

>> Emtek SELECT Lever and Knob(s) with Marble, Terrazzo and Walnut handles feature a living finish that will age gracefully and evolve over time, enhancing the character of your space. Due to this unique characteristic, no finish warranty is offered on these products. All SELECT lever and knobs featuring Marble, Terrazzo and Walnut are intended for indoor use.

• Handing NOT Required

- Standard latch is for 2 3/8" backset. Specify 2 3/4" backset if required.
- Complete set includes standard rotation latch, strike plate and dust box. Specify Drive-in latch if required.
- Latches come standard with square corner strike and face plates. Specify radius corners if required.
- To order 28° rotation latch with any standard knobset, add product code **Latch28** and list price **\$7**
- Select knobsets may also be ordered with any Brass rosette at the list price shown above.

For more information

- See page 170 for Concealed Fastener (C)
- See pages 130-131 for Interior Mortise (M)

To order: (Optional Upgrade) Rosette/Finish . Stem/Finish . Knob/Finish + Add Door Thickness to Comments

MIX MATCH THUMBTURN PRIVACY BOLTS

Thumbturn Privacy Bolts
Mix-Match Style & Finish
for thumbturn and rosettes:

- 4 thumbturn designs in 10 finishes
- 4 rosette designs in 10 finishes
- Double rosette styles with Indicator
- Includes privacy latch and strike plate
- Includes emergency release tool



Emergency Release Key
for Single Rosette



Emergency Release Coin
for Double Rosettes



Exterior (Single Rosette)



Exterior (Double Rosettes)



Exterior (Double Rosettes with Indicator)





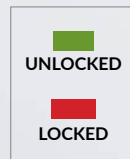





Interior (Single & Double Rosettes)



To order:

8581US19 . RECUS4 + Add Door Thickness
to Comments
Rosette/Finish + Thumbturn Style/Finish



ROSETTE	Description	Product Code	THUMBTURN STYLE	Standard List Price
 Disk	Single Rosette	8681	  ARCHED (ARC) ARCHED STEP (ARS)	\$60
	Double Rosettes	8682		\$78
	Double Rosettes with Indicator	8683		\$86
 Square	Single Rosette	8581	  RECTANGULAR (REC) RECTANGULAR STEP (RES)	\$60
	Double Rosettes	8582		\$78
	Double Rosettes with Indicator	8583		\$86
 Watford	Single Rosette	8481		\$60
	Double Rosettes	8482		\$78
	Double Rosettes with Indicator	8483		\$86
 Wilshire	Single Rosette	8381		\$60
	Double Rosettes	8382		\$78
	Double Rosettes with Indicator	8383		\$86

Finish options for ROSETTE and THUMBTURN



• **Handing Required for Leversets. Knob/Lever Lockset sold separately.**

- Fits door thickness 1 3/8" to 1 3/4". Specify if thicker.
- Standard latch is for 2 3/8" backset. Specify 2 3/4" backset if required.
- Complete set includes latch, strike plate and emergency release tool.
- Thumbturn privacy bolt only available with square corner latch face plate.
- Thumbturn privacy bolt can be used with any Brass passage set.

*Unlacquered Brass (US3NL) finish available for a \$10 List Price upcharge per item.

KNOBSETS - STUDIO BRASS

The Studio Brass Collection

Introduces boutique designs, inspired by the world beyond door hardware.

Available in 10 finishes including:

- Pewter (gunmetal tones)
- French Antique (vintage, burnished tones)
- Satin Rose Gold
- Matte White



Spoke Knob
with Disk Rosette
in Pewter (US15A) Finish



The Ace Knurled Knob
with Urban Modern Rosette
in French Antique (US7) Finish



The Ace Knurled Knob
with Quincy Rosette
in Satin Rose Gold (SRG) Finish



Spoke Knob
with Square Rosette
in Matte White (MW) Finish

Spoke Knob
with Disk Rosette



Spoke Knob
with Square Rosette



Spoke Knob
with Modern Rectangular Rosette



Spoke Knob
with Urban Modern Rosette



The Ace Knob
with Disk Rosette



The Ace Knob
with Square Rosette



The Ace Knurled Knob
with Quincy Rosette



The Ace Knurled Knob
with Urban Modern Rosette



ROSETTE	Description	Optional Upgrade	Product Code	Knob Style	Finish	Standard List Price	C List Price	M List Price
	Passage Set	C or M	5109	The Ace Knob (ACE) The Ace Knurled Knob (ACEKN) Spoke Knob (SPK)	Satin Brass (US4) French Antique (US7) Polished Nickel - Lifetime (US14) Satin Nickel (US15) Pewter (US15A)** Flat Black (US19) Polished Chrome (US26) Matte White (MW)** Satin Rose Gold (SRG)** Unlacquered Brass (US3NL)*	\$295	\$339	\$495
	Privacy Set	C or M	5209			\$295	\$339	\$495
	Dummy		5059			\$295		
	Passage Set	C or M	5110			\$295	\$339	\$495
	Privacy Set	C or M	5210			\$295	\$339	\$495
	Dummy		5050			\$295		
	Passage Set	C or M	5112			\$295	\$339	\$495
	Privacy Set	C or M	5212			\$295	\$339	\$495
	Dummy		5052			\$295		
	Passage Set	C or M	5316	\$295	\$339	\$495		
	Privacy Set	C or M	5326	\$295	\$339	\$495		
	Dummy		5306	\$295				
	Passage Set	C or M	8131	\$295	\$339	\$495		
	Privacy Set	C or M	8231	\$295	\$339	\$495		
	Dummy		8531	\$295				

*Unlacquered Brass (US3NL) finish available for a \$20 List Price upcharge per item.

**Finish NOT available for Modern Rectangular Rosette.

• **Handing is Required for Spoke Knob in Privacy Optional Upgrade, Split Finish and Split Style.**

- Standard latch is for 2¾" backset. Specify 2¾" backset if required.
- Complete set includes standard rotation latch, strike plate and dust box. Specify Drive-in latch if required.
- Latches come standard with square corner strike and face plates. Specify radius corners if required.
- To order 28° rotation latch with any standard knobset, add product code **Latch28** and list price **\$7**
- Studio Knobset may also be ordered with any Brass rosette at the list price shown above.

For more information

- See page 170 for Concealed Fastener (C)
- See pages 130-131 for Interior Mortise (M)

To order: (Optional Upgrade) Product Code + Knob Style + Handing + Finish + Add Door Thickness to Comments

Athena Lever
with Neos Rosette



Helios Lever
with Square Rosette

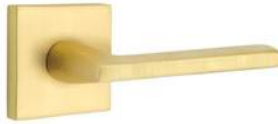

Hermes Lever
with Modern Rosette



Luzern Lever
with Square Rosette





Poseidon Lever
with Modern Rectangular Rosette



Stuttgart Lever
with Square Rosette



ROSETTE	Description	Optional Upgrade	Product Code	Lever Style	Finish	Standard List Price	C List Price	M List Price
	Passage Set	C or M	5107	Athena Lever (ATN) Helios Lever (HLO) Hermes Lever (HER) Luzern Lever (LU) Poseidon Lever (POS) Stuttgart Lever (STU)	Satin Brass (US4) French Antique (US7) Oil Rubbed Bronze (US10B) Polished Nickel - Lifetime (US14) Satin Nickel (US15) Flat Black (US19) Polished Chrome (US26) Unlacquered Brass (US3NL)*	\$165	\$216	\$365
	Privacy Set	C or M	5207			\$165	\$216	\$365
	Dummy		5057			\$165		
	Passage Set	C or M	5109			\$165	\$216	\$365
	Privacy Set	C or M	5209			\$165	\$216	\$365
	Dummy		5059			\$165		
	Passage Set	C or M	5110			\$165	\$216	\$365
	Privacy Set	C or M	5210			\$165	\$216	\$365
	Dummy		5050			\$165		
	Passage Set	C or M	5111			\$165	\$216	\$365
	Privacy Set	C or M	5211			\$165	\$216	\$365
	Dummy		5051			\$165		
	Passage Set	C or M	5112			\$165	\$216	\$365
	Privacy Set	C or M	5212			\$165	\$216	\$365
	Dummy		5052			\$165		
	Passage Set	C or M	5316	\$165	\$216	\$365		
	Privacy Set	C or M	5326	\$165	\$216	\$365		
	Dummy		5306	\$165				

*Unlacquered Brass (US3NL) finish available for a \$20 List Price upcharge per item.

• **Handing Required for Leversets**

- Standard latch is for 2 3/8" backset. Specify 2 3/4" backset if required.
- Complete set includes standard rotation latch and strike plate. Specify Drive-in latch if required.
- Latches come standard with square corner strike and face plates. Specify radius corners if required.
- To order 28° rotation latch with any standard leverset, add product code **Latch28** and list price **\$7**
- Modern leversets may also be ordered with any Brass rosette at the list price shown above.

For more information

- See page 170 for **Concealed Fastener (C)**
- See pages 130-131 for **Interior Mortise (M)**

Orb Knob
with Modern Rosette



Orb Knob
with Disk Rosette



Orb Knob
with Modern Rectangular Rosette



Round Knob
with Disk Rosette









Round Knob
with Square Rosette



Round Knob
with Urban Modern Rosette



ROSETTE	Description	Optional Upgrade	Product Code	Knob Style	Finish	Standard List Price	C List Price	M List Price
	Passage Set	C or M	5107	Orb Knob (OR) Round Knob (ROU)	Satin Brass (US4) French Antique (US7) Oil Rubbed Bronze (US10B) Polished Nickel - Lifetime (US14) Satin Nickel (US15) Flat Black (US19) Polished Chrome (US26) Unlacquered Brass (US3NL)*	\$165	\$209	\$365
	Privacy Set	C or M	5207			\$165	\$209	\$365
	Dummy		5057			\$165		
	Passage Set	C or M	5109			\$165	\$209	\$365
	Privacy Set	C or M	5209			\$165	\$209	\$365
	Dummy		5059			\$165		
	Passage Set	C or M	5110			\$165	\$209	\$365
	Privacy Set	C or M	5210			\$165	\$209	\$365
	Dummy		5050			\$165		
	Passage Set	C or M	5111			\$165	\$209	\$365
	Privacy Set	C or M	5211			\$165	\$209	\$365
	Dummy		5051			\$165		
	Passage Set	C or M	5112	\$165	\$209	\$365		
	Privacy Set	C or M	5212	\$165	\$209	\$365		
	Dummy		5052	\$165				
	Passage Set	C or M	5316	\$165	\$209	\$365		
	Privacy Set	C or M	5326	\$165	\$209	\$365		
	Dummy		5306	\$165				

*Unlacquered Brass (US3NL) finish available for a \$20 List Price upcharge per item.

• **Handing Not Required for Knobsets**

- Standard latch is for 2 3/8" backset. Specify 2 3/4" backset if required.
- Complete set includes standard rotation latch and strike plate. Specify Drive-in latch if required.
- Latches come standard with square corner strike and face plates. Specify radius corners if required.
- To order 28° rotation latch with any standard knobset, add product code **Latch28** and list price **\$7**
- Modern knobsets may also be ordered with any Brass rosette at the list price shown above.

For more information

- See page 170 for Concealed Fastener (C)
- See pages 130-131 for Interior Mortise (M)

To order: (Optional Upgrade) Product Code + Knob Style + Finish + Add Door Thickness to Comments

Argos Lever
with Modern Rectangular Rosette



Aston Lever
with Urban Modern Rosette



Basel Lever
with Disk Rosette



Breslin Lever
with Square Rosette



Dumont Lever
with Square Rosette







Geneva Lever
with Modern Rectangular Rosette



Freestone Lever
with Disk Rosette



ROSETTE	Description	Optional Upgrade	Product Code	Lever Style	Finish	Standard List Price	C List Price	M List Price
	Passage Set	C or M	5107	Argos Lever (AG) Aston Lever (AST) Basel Lever (BA) Breslin Lever (BRL) Dumont Lever (DT) Freestone Lever (FRL) Geneva Lever (GV)	Satin Brass (US4) French Antique (US7) Oil Rubbed Bronze (US10B) Polished Nickel - Lifetime (US14) Satin Nickel (US15) Flat Black (US19) Polished Chrome (US26) Unlacquered Brass (US3NL)*	\$209	\$260	\$409
	Privacy Set	C or M	5207			\$209	\$260	\$409
	Dummy		5057			\$209		
	Passage Set	C or M	5109			\$209	\$260	\$409
	Privacy Set	C or M	5209			\$209	\$260	\$409
	Dummy		5059			\$209		
	Passage Set	C or M	5110			\$209	\$260	\$409
	Privacy Set	C or M	5210			\$209	\$260	\$409
	Dummy		5050			\$209		
	Passage Set	C or M	5111			\$209	\$260	\$409
	Privacy Set	C or M	5211			\$209	\$260	\$409
	Dummy		5051			\$209		
	Passage Set	C or M	5112	\$209	\$260	\$409		
	Privacy Set	C or M	5212	\$209	\$260	\$409		
	Dummy		5052	\$209				
	Passage Set	C or M	5316	\$209	\$260	\$409		
	Privacy Set	C or M	5326	\$209	\$260	\$409		
	Dummy		5306	\$209				

*Unlacquered Brass (US3NL) finish available for a \$20 List Price upcharge per item.

• Handing Required for Leversets

- Standard latch is for 2¾" backset. Specify 2¾" backset if required.
- Complete set includes standard rotation latch and strike plate. Specify Drive-in latch if required.
- Latches come standard with square corner strike and face plates. Specify radius corners if required.
- To order 28° rotation latch with any standard leverset, add product code **Latch28** and list price \$7
- Modern leversets may also be ordered with any Brass rosette at the list price shown above.

For more information

- See page 170 for Concealed Fastener (C)
- See pages 130-131 for Interior Mortise (M)

Hercules Lever
with Disk Rosette



Mercury Lever
with Square Rosette



Myles Lever
with Disk Rosette



Sion Lever
with Disk Rosette









Spencer Lever
with Urban Modern Rosette



Triton Lever
with Modern Rectangular Rosette



ROSETTE	Description	Optional Upgrade	Product Code	Lever Style	Finish	Standard List Price	C List Price	M List Price
	Passage Set	C or M	5107	Hercules Lever (HEC) Mercury Lever (MC) Myles Lever (MYL) Sion Lever (SIO) Spencer Lever (SPN) Triton Lever (TRT)	Satin Brass (US4) French Antique (US7) Oil Rubbed Bronze (US10B) Polished Nickel - Lifetime (US14) Satin Nickel (US15) Flat Black (US19) Polished Chrome (US26) Unlacquered Brass (US3NL)*	\$209	\$260	\$409
	Privacy Set	C or M	5207			\$209	\$260	\$409
	Dummy		5057			\$209		
	Passage Set	C or M	5109			\$209	\$260	\$409
	Privacy Set	C or M	5209			\$209	\$260	\$409
	Dummy		5059			\$209		
	Passage Set	C or M	5110			\$209	\$260	\$409
	Privacy Set	C or M	5210			\$209	\$260	\$409
	Dummy		5050			\$209		
	Passage Set	C or M	5111			\$209	\$260	\$409
	Privacy Set	C or M	5211			\$209	\$260	\$409
	Dummy		5051			\$209		
	Passage Set	C or M	5112	\$209	\$260	\$409		
	Privacy Set	C or M	5212	\$209	\$260	\$409		
	Dummy		5052	\$209				
	Passage Set	C or M	5316	\$209	\$260	\$409		
	Privacy Set	C or M	5326	\$209	\$260	\$409		
	Dummy		5306	\$209				

*Unlacquered Brass (US3NL) finish available for a \$20 List Price upcharge per item.

• **Handing Required for Leversets**

- Standard latch is for 2¾" backset. Specify 2¾" backset if required.
- Complete set includes standard rotation latch and strike plate. Specify Drive-in latch if required.
- Latches come standard with square corner strike and face plates. Specify radius corners if required.
- To order 28° rotation latch with any standard leverset, add product code **Latch28** and list price **\$7**
- Modern leversets may also be ordered with any Brass rosette at the list price shown above.

For more information

- See page 170 for **Concealed Fastener (C)**
- See pages 130-131 for **Interior Mortise (M)**

To order: (Optional Upgrade) Product Code + Lever Style + Handing + Finish + Add Door Thickness to Comments

Bern Knob
with Square Rosette



Freestone Knob
with Urban Modern Rosette



Laurent Knob
with Urban Modern Rosette



Octagon Knob
with Modern Rosette



Hammered Egg Knob
with Square Rosette









Square Knob
with Modern Rectangular Rosette



Verve Knob
with Disk Rosette



ROSETTE	Description	Optional Upgrade	Product Code	Knob Style	Finish	Standard List Price	C List Price	M List Price
	Passage Set	C or M	5107	Bern Knob (BN) Freestone Knob (FRK) Hammered Egg Knob (HE) Laurent Knob (LAU) Octagon Knob (OCT) Square Knob (SQU) Verve Knob (VR)	Satin Brass (US4) French Antique (US7) Oil Rubbed Bronze (US10B) Polished Nickel - Lifetime (US14) Satin Nickel (US15) Flat Black (US19) Polished Chrome (US26) Unlacquered Brass (US3NL)*	\$209	\$253	\$409
	Privacy Set	C or M	5207			\$209	\$253	\$409
	Dummy		5057			\$209		
	Passage Set	C or M	5109			\$209	\$253	\$409
	Privacy Set	C or M	5209			\$209	\$253	\$409
	Dummy		5059			\$209		
	Passage Set	C or M	5110			\$209	\$253	\$409
	Privacy Set	C or M	5210			\$209	\$253	\$409
	Dummy		5050			\$209		
	Passage Set	C or M	5111			\$209	\$253	\$409
	Privacy Set	C or M	5211	\$209	\$253	\$409		
	Dummy		5051	\$209				
	Passage Set	C or M	5112	\$209	\$253	\$409		
	Privacy Set	C or M	5212	\$209	\$253	\$409		
	Dummy		5052	\$209				
	Passage Set	C or M	5316	\$209	\$253	\$409		
	Privacy Set	C or M	5326	\$209	\$253	\$409		
	Dummy		5306	\$209				

*Unlacquered Brass (US3NL) finish available for a \$20 List Price upcharge per item.

• Handing Not Required for Knobsets

- Standard latch is for 2 3/8" backset. Specify 2 3/4" backset if required.
- Complete set includes standard rotation latch and strike plate. Specify Drive-in latch if required.
- Latches come standard with square corner strike and face plates. Specify radius corners if required.
- To order 28° rotation latch with any standard knobset, add product code **Latch28** and list price **\$7**
- Modern knobsets may also be ordered with any Brass rosette at the list price shown above.

For more information

- See page 170 for Concealed Fastener (C)
- See pages 130-131 for Interior Mortise (M)

**Bristol Glass Knob
with Square Rosette**



**Hampton Glass Knob
with Neos Rosette**



**Modern Disc Glass Knob
with Disk Rosette**









**Modern Square Glass Knob
with Disk Rosette**



**Windsor Glass Knob
with Modern Rectangular Rosette**



ROSETTE	Description	Optional Upgrade	Product Code	Glass Knob Style	Finish	Standard List Price	C List Price	M List Price
	Passage Set	C or M	5107	Bristol Knob (BL) Hampton Knob (HT) Modern Disc Knob (MDC) Modern Square Knob (MSC) Windsor Knob (WS)	Satin Brass (US4) French Antique (US7) Oil Rubbed Bronze (US10B) Polished Nickel - Lifetime (US14) Satin Nickel (US15) Flat Black (US19) Polished Chrome (US26) Unlacquered Brass (US3NL)*	\$209	\$253	\$409
	Privacy Set	C or M	5207			\$209	\$253	\$409
	Dummy		5057			\$209		
	Passage Set	C or M	5109			\$209	\$253	\$409
	Privacy Set	C or M	5209			\$209	\$253	\$409
	Dummy		5059			\$209		
	Passage Set	C or M	5110			\$209	\$253	\$409
	Privacy Set	C or M	5210			\$209	\$253	\$409
	Dummy		5050			\$209		
	Passage Set	C or M	5111			\$209	\$253	\$409
	Privacy Set	C or M	5211	\$209	\$253	\$409		
	Dummy		5051	\$209				
	Passage Set	C or M	5112	\$209	\$253	\$409		
	Privacy Set	C or M	5212	\$209	\$253	\$409		
	Dummy		5052	\$209				
	Passage Set	C or M	5316	\$209	\$253	\$409		
	Privacy Set	C or M	5326	\$209	\$253	\$409		
	Dummy		5306	\$209				

*Unlacquered Brass (US3NL) finish available for a \$20 List Price upcharge per item.

• Handing Not Required for Knobsets

- Standard latch is for 2³/₈" backset. Specify 2³/₄" backset if required.
- Complete set includes standard rotation latch and strike plate. Specify Drive-in Latch if required.
- Latches come standard with square corner strike and face plates. Specify radius corners if required.
- To order 28° rotation latch with any standard knobset, add product code **Latch28** and list price **\$7**
- Modern Glass knobsets may also be ordered with any Brass rosette at the list price shown above.

For more information

- See page 170 for Concealed Fastener (C)
- See pages 130-131 for Interior Mortise (M)

To order: (Optional Upgrade) Product Code + Knob Style + Finish + Add Door Thickness to Comments

Cortina Lever with #8 Rosette



Merrimack Lever with Quincv Rosette



Milano Lever with Wilshire Rosette



Turino Lever with Quincy Rosette



Cortina Lever with Regular Rosette



Merrimack Lever with Oval Rosette









Manning Lever with Watford Rosette



Turino Lever with Rectangular Rosette



ROSETTE	Description	Optional Upgrade	Product Code	Lever Style	Finish	Standard List Price	C List Price	M List Price
	Passage Set	C or M	8108	Cortina Lever (C) Manning Lever (MNG) Merrimack Lever (ME) Milano Lever (M) Turino Lever (T)	Polished Brass - Lifetime (US3) Satin Brass (US4) French Antique (US7) Oil Rubbed Bronze (US10B) Polished Nickel - Lifetime (US14) Satin Nickel (US15) Pewter (US15A) Flat Black (US19) Polished Chrome (US26) Unlacquered Brass (US3NL)*	\$165	\$216	\$365
	Privacy Set	C or M	8208			\$165	\$216	\$365
	Dummy		8058			\$165		
	Passage Set	C or M	8120			\$165	\$216	\$365
	Privacy Set	C or M	8220			\$165	\$216	\$365
	Dummy		8520			\$165		
	Passage Set	C or M	8100			\$165	\$216	\$365
	Privacy Set	C or M	8200			\$165	\$216	\$365
	Dummy		8050			\$165		
	Passage Set	C or M	8121			\$165	\$216	\$365
	Privacy Set	C or M	8221			\$165	\$216	\$365
	Dummy		8521			\$165		
	Passage Set	C or M	8131	\$165	\$216	\$365		
	Privacy Set	C or M	8231	\$165	\$216	\$365		
	Dummy		8531	\$165				
	Passage Set	C or M	8110	\$165	\$216	\$365		
	Privacy Set	C or M	8210	\$165	\$216	\$365		
	Dummy		8510	\$165				
	Passage Set	C or M	8161	\$165	\$216	\$365		
	Privacy Set	C or M	8261	\$165	\$216	\$365		
	Dummy		8561	\$165				

*Unlacquered Brass (US3NL) finish available for a \$20 List Price upcharge per item.

• **Handing Required for Leversets**

- Standard latch is for 2 3/8" backset. Specify 2 3/4" backset if required.
- Complete set includes standard rotation latch and strike plate. Specify Drive-in latch if required.
- Latches come standard with square corner strike and face plates. Specify radius corners if required.
- To order 28° rotation latch with any standard leverset, add product code **Latch28** and list price **\$7**
- Classic leversets may also be ordered with any Modern rosette at the list price shown above.

For more information

- See page 170 for Concealed Fastener (C)
- See pages 130-131 for Interior Mortise (M)

**Cortina Lever
with Ribbon & Reed Rosette**



**Merrimack Lever
with Rope Rosette**



**Milano Lever
with Ribbon & Reed Rosette**



**Turino Lever
with Lancaster Rosette**



**Cortina Lever
with 7" Wilshire Sideplate**



**Merrimack Lever
with 7" Wilshire Sideplate**



**Milano Lever
with 7" Wilshire Sideplate**



**Manning Lever
with 7" Wilshire Sideplate**



ROSETTE	Description	Optional Upgrade	Product Code	Lever Style	Finish	Standard List Price	C List Price	M List Price
	Passage Set	C or M	8101	Cortina Lever (C) Manning Lever (MNG) Merrimack Lever (ME) Milano Lever (M) Turino Lever (T)	Polished Brass - Lifetime (US3) French Antique (US7) Oil Rubbed Bronze (US10B) Satin Nickel (US15) Pewter (US15A) Polished Chrome (US26) Unlacquered Brass (US3NL)*	\$165	\$216	\$365
	Privacy Set	C or M	8201			\$165	\$216	\$365
	Dummy		8051			\$165		
	Passage Set	C or M	8106			\$165	\$216	\$365
	Privacy Set	C or M	8206			\$165	\$216	\$365
	Dummy		8056			\$165		
	Passage Set	C or M	8107			\$165	\$216	\$365
	Privacy Set	C or M	8207			\$165	\$216	\$365
	Dummy		8057			\$165		

SIDEPLATE	Description	Optional Upgrade	Product Code	Lever Style	Finish	Standard List Price	C List Price
	Passage Set	C	8135	Cortina Lever (C) Manning Lever (MNG) Merrimack Lever (ME) Milano Lever (M) Turino Lever (T)	Polished Brass - Lifetime (US3) Satin Brass (US4) French Antique (US7) Oil Rubbed Bronze (US10B) Polished Nickel - Lifetime (US14) Satin Nickel (US15) Pewter (US15A) Flat Black (US19) Polished Chrome (US26) Unlacquered Brass (US3NL)*	\$266	\$317
	Privacy Set	C	8235			\$266	\$317
	Dummy		8035			\$266	

*Unlacquered Brass (US3NL) finish available for a \$20 List Price upcharge per item.

• Handing Required for Leversets

- Standard latch is for 2¾" backset. Specify 2¾" backset if required.
- Complete set includes standard rotation latch and strike plate. Specify Drive-in latch if required.
- Latches come standard with square corner strike and face plates. Specify radius corners if required.
- To order 28° rotation latch with any standard leverset, add product code **Latch28** and list price **\$7**
- Classic leversets may also be ordered with any Modern rosette at the list price shown above.

For more information

- See page 170 for **Concealed Fastener (C)**
- See pages 130-131 for **Interior Mortise (M)**

To order: (Optional Upgrade) Product Code + Lever Style + Handing + Finish + Add Door Thickness to Comments

Egg Knob
with Regular Rosette



Melon Knob
with Regular Rosette



Norwich Knob
with #8 Rosette



Providence Knob
with Quincy Rosette



Egg Knob
with Rectangular Rosette



Providence Knob
with Watford Rosette









Norwich Knob
with Wilshire Rosette



Waverly Knob
with Quincy Rosette



ROSETTE	Description	Optional Upgrade	Product Code	Knob Style	Finish	Standard List Price	C List Price	M List Price
	Passage Set	C or M	8108	Egg Knob (E) Melon Knob (MN) Norwich Knob (NW) Providence Knob (P) Waverly Knob (W)	Polished Brass - Lifetime (US3) Satin Brass (US4) French Antique (US7) Oil Rubbed Bronze (US10B) Polished Nickel - Lifetime (US14) Satin Nickel (US15) Pewter (US15A) Flat Black (US19) Polished Chrome (US26) Unlacquered Brass (US3NL)*	\$165	\$209	\$365
	Privacy Set	C or M	8208			\$165	\$209	\$365
	Dummy		8058			\$165		
	Passage Set	C or M	8120			\$165	\$209	\$365
	Privacy Set	C or M	8220			\$165	\$209	\$365
	Dummy		8520			\$165		
	Passage Set	C or M	8100			\$165	\$209	\$365
	Privacy Set	C or M	8200			\$165	\$209	\$365
	Dummy		8050			\$165		
	Passage Set	C or M	8121			\$165	\$209	\$365
	Privacy Set	C or M	8221	\$165	\$209	\$365		
	Dummy		8521	\$165				
	Passage Set	C or M	8131	\$165	\$209	\$365		
	Privacy Set	C or M	8231	\$165	\$209	\$365		
	Dummy		8531	\$165				
	Passage Set	C or M	8110	\$165	\$209	\$365		
	Privacy Set	C or M	8210	\$165	\$209	\$365		
	Dummy		8510	\$165				
	Passage Set	C or M	8161	\$165	\$209	\$365		
	Privacy Set	C or M	8261	\$165	\$209	\$365		
	Dummy		8561	\$165				

*Unlacquered Brass (US3NL) finish available for a \$20 List Price upcharge per item.

- **Handing Not Required for Knobsets**
- Standard latch is for 2¾" backset. Specify 2¾" backset if required.
- Complete set includes standard rotation latch and strike plate. Specify Drive-in latch if required.
- Latches come standard with square corner strike and face plates. Specify radius corners if required.
- To order 28° rotation latch with any standard knobset, add product code **Latch28** and list price **\$7**
- Classic knobsets may also be ordered with any Modern rosette at the list price shown above.

For more information
 • See page 170 for Concealed Fastener (C)
 • See pages 130-131 for Interior Mortise (M)

**Egg Knob
with Rope Rosette**



**Melon Knob
with Rope Rosette**



**Norwich Knob
with Lancaster Rosette**



**Providence Knob
with Ribbon & Reed Rosette**



**Egg Knob
with 7" Wilshire Sideplate**



**Waverly Knob
with 7" Wilshire Sideplate**





**Norwich Knob
with 7" Wilshire Sideplate**



**Providence Knob
with 7" Wilshire Sideplate**



ROSETTE	Description	Optional Upgrade	Product Code	Knob Style	Finish	Standard List Price	C List Price	M List Price
	Passage Set	C or M	8101	Egg Knob (E) Melon Knob (MN) Norwich Knob (NW) Providence Knob (P) Waverly Knob (W)	Polished Brass - Lifetime (US3) French Antique (US7) Oil Rubbed Bronze (US10B) Satin Nickel (US15) Pewter (US15A) Polished Chrome (US26) Unlacquered Brass (US3NL)*	\$165	\$209	\$365
	Privacy Set	C or M	8201			\$165	\$209	\$365
	Dummy		8051			\$165		
	Passage Set	C or M	8106			\$165	\$209	\$365
	Privacy Set	C or M	8206			\$165	\$209	\$365
	Dummy		8056			\$165		
	Passage Set	C or M	8107			\$165	\$209	\$365
	Privacy Set	C or M	8207			\$165	\$209	\$365
	Dummy		8057			\$165		

SIDEPLATE	Description	Optional Upgrade	Product Code	Knob Style	Finish	Standard List Price	C List Price
	Passage Set	C	8135	Egg Knob (E) Melon Knob (MN) Norwich Knob (NW) Providence Knob (P) Waverly Knob (W)	Polished Brass - Lifetime (US3) Satin Brass (US4) French Antique (US7) Oil Rubbed Bronze (US10B) Polished Nickel - Lifetime (US14) Satin Nickel (US15) Pewter (US15A) Flat Black (US19) Polished Chrome (US26) Unlacquered Brass (US3NL)*	\$266	\$310
	Privacy Set	C	8235			\$266	\$310
	Dummy		8035			\$266	

*Unlacquered Brass (US3NL) finish available for a \$20 List Price upcharge per item.

- **Handing Not Required for Knobsets**
- Standard latch is for 2¾" backset. Specify 2¾" backset if required.
- Complete set includes standard rotation latch and strike plate. Specify Drive-in latch if required.
- Latches come standard with square corner strike and face plates. Specify radius corners if required.
- To order 28° rotation latch with any standard knobset, add product code **Latch28** and list price **\$7**
- Classic knobsets may also be ordered with any Modern rosette at the list price shown above.

For more information
 • See page 170 for Concealed Fastener (C)
 • See pages 130-131 for Interior Mortise (M)

To order: (Optional Upgrade) Product Code + Knob Style + Finish + Add Door Thickness to Comments

Coventry Lever with Regular Rosette



Elan Lever with #8 Rosette



Ribbon & Reed Lever with Oval Rosette



Rope Lever with Rectangular Rosette



Rustic Lever with Oval Rosette



Santa Fe Lever with Watford Rosette









Wembley Lever with #8 Rosette



Santa Fe Lever with Wilshire Rosette



ROSETTE	Description	Optional Upgrade	Product Code	Lever Style	Finish	Standard List Price	C List Price	C List Price
	Passage Set	C or M	8108	Coventry Lever (CV) Elan Lever (EN) Ribbon & Reed Lever (RBL) Rope Lever (RL) Rustic Lever (R) Santa Fe Lever (SF) Wembley Lever (WM)	Polished Brass - Lifetime (US3) French Antique (US7) Oil Rubbed Bronze (US10B) Satin Nickel (US15) Pewter (US15A) Polished Chrome (US26) Unlacquered Brass (US3NL)*	\$209	\$260	\$409
	Privacy Set	C or M	8208			\$209	\$260	\$409
	Dummy		8058			\$209		
	Passage Set	C or M	8120			\$209	\$260	\$409
	Privacy Set	C or M	8220			\$209	\$260	\$409
	Dummy		8520			\$209		
	Passage Set	C or M	8100			\$209	\$260	\$409
	Privacy Set	C or M	8200			\$209	\$260	\$409
	Dummy		8050			\$209		
	Passage Set	C or M	8121			\$209	\$260	\$409
	Privacy Set	C or M	8221	\$209	\$260	\$409		
	Dummy		8521	\$209				
	Passage Set	C or M	8131	\$209	\$260	\$409		
	Privacy Set	C or M	8231	\$209	\$260	\$409		
	Dummy		8531	\$209				
	Passage Set	C or M	8110	\$209	\$260	\$409		
	Privacy Set	C or M	8210	\$209	\$260	\$409		
	Dummy		8510	\$209				
	Passage Set	C or M	8161	\$209	\$260	\$409		
	Privacy Set	C or M	8261	\$209	\$260	\$409		
	Dummy		8561	\$209				

*Unlacquered Brass (US3NL) finish available for a \$20 List Price upcharge per item.

• **Handing Required for Leversets**

- Standard latch is for 2 3/8" backset. Specify 2 1/4" backset if required.
- Complete set includes standard rotation latch and strike plate. Specify Drive-in latch if required.
- Latches come standard with square corner strike and face plates. Specify radius corners if required.
- To order 28° rotation latch with any standard leverset, add product code **Latch28** and list price \$7
- Designer leversets may also be ordered with any Modern rosette at the list price shown above.

For more information

- See page 170 for Concealed Fastener (C)
- See pages 130-131 for Interior Mortise (M)

Elan Lever
with Ribbon & Reed Rosette



Rustic Lever
with Rope Rosette



Ribbon & Reed Lever
with Ribbon & Reed Rosette



Wembley Lever
with Lancaster Rosette



Rope Lever
with 7" Wilshire Sideplate



Coventry Lever
with 7" Wilshire Sideplate



Elan Lever
with 7" Wilshire Sideplate



Santa Fe Lever
with 7" Wilshire Sideplate



ROSETTE	Description	Optional Upgrade	Product Code	Lever Style	Finish	Standard List Price	C List Price	M List Price
 <p>Rope</p>	Passage Set	C or M	8101	Coventry Lever (CV)	Polished Brass - Lifetime (US3) French Antique (US7) Oil Rubbed Bronze (US10B) Satin Nickel (US15) Pewter (US15A) Polished Chrome (US26) Unlacquered Brass (US3NL)*	\$209	\$260	\$409
	Privacy Set	C or M	8201	Elan Lever (EN)				
	Dummy		8051	Ribbon & Reed Lever (RBL)				
 <p>Lancaster</p>	Passage Set	C or M	8106	Rope Lever (RL)				
	Privacy Set	C or M	8206	Rustic Lever (R)				
	Dummy		8056	Santa Fe Lever (SF)				
 <p>Ribbon & Reed</p>	Passage Set	C or M	8107	Wembley Lever (WM)		\$209	\$260	\$409
	Privacy Set	C or M	8207			\$209	\$260	\$409
	Dummy		8057			\$209		

SIDEPLATE	Description	Optional Upgrade	Product Code	Lever Style	Finish	Standard List Price	C List Price
 <p>7" Wilshire</p>	Passage Set	C	8135	Coventry Lever (CV)	Polished Brass - Lifetime (US3) French Antique (US7) Oil Rubbed Bronze (US10B) Satin Nickel (US15) Pewter (US15A) Polished Chrome (US26) Unlacquered Brass (US3NL)*	\$266	\$317
	Privacy Set	C	8235	Elan Lever (EN)			
	Dummy		8035	Ribbon & Reed Lever (RBL)			

*Unlacquered Brass (US3NL) finish available for a \$20 List Price upcharge per item.

- **Handing Required for Leversets**
- Standard latch is for 2 3/8" backset. Specify 2 3/4" backset if required.
- Complete set includes standard rotation latch and strike plate. Specify Drive-in latch if required.
- Latches come standard with square corner strike and face plates. Specify radius corners if required.
- To order 28° rotation latch with any standard leverset, add product code **Latch28** and list price **\$7**
- Designer leversets may also be ordered with any Modern rosette at the list price shown above.

For more information
 • See page 170 for Concealed Fastener (C)
 • See pages 130-131 for Interior Mortise (M)

To order: (Optional Upgrade) Product Code + Lever Style + Handing + Finish + Add Door Thickness to Comments

**Victoria Knob
with Watford Rosette**



**Lancaster Knob
with #8 Rosette**



**Victoria Knob
with Oval Rosette**



**Belmont Knob
with Wilshire Rosette**









**Ribbon & Reed Knob
with Watford Rosette**



**Belmont Knob
with Quincy Rosette**



ROSETTE	Description	Optional Upgrade	Product Code	Knob Style	Finish	Standard List Price	C List Price	M List Price
	Passage Set	C or M	8108	Belmont Knob (BT) Lancaster Knob (LN) Ribbon & Reed Knob (RBK) Rope Knob (RK) Victoria Knob (V)	Polished Brass - Lifetime (US3) French Antique (US7) Oil Rubbed Bronze (US10B) Satin Nickel (US15) Pewter (US15A) Polished Chrome (US26) Unlacquered Brass (US3NL)*	\$209	\$253	\$409
	Privacy Set	C or M	8208			\$209	\$253	\$409
	Dummy		8058			\$209		
	Passage Set	C or M	8120			\$209	\$253	\$409
	Privacy Set	C or M	8220			\$209	\$253	\$409
	Dummy		8520			\$209		
	Passage Set	C or M	8100			\$209	\$253	\$409
	Privacy Set	C or M	8200			\$209	\$253	\$409
	Dummy		8050			\$209		
	Passage Set	C or M	8121			\$209	\$253	\$409
	Privacy Set	C or M	8221	\$209	\$253	\$409		
	Dummy		8521	\$209				
	Passage Set	C or M	8131	\$209	\$253	\$409		
	Privacy Set	C or M	8231	\$209	\$253	\$409		
	Dummy		8531	\$209				
	Passage Set	C or M	8110	\$209	\$253	\$409		
	Privacy Set	C or M	8210	\$209	\$253	\$409		
	Dummy		8510	\$209				
	Passage Set	C or M	8161	\$209	\$253	\$409		
	Privacy Set	C or M	8261	\$209	\$253	\$409		
	Dummy		8561	\$209				

*Unlacquered Brass (US3NL) finish available for a \$20 List Price upcharge per item.

• Handing Not Required for Knobsets

- Standard latch is for 2³/₈" backset. Specify 2³/₄" backset if required.
- Complete set includes standard rotation latch and strike plate. Specify Drive-in Latch if required.
- Latches come standard with square corner strike and face plates. Specify radius corners if required.
- To order 28° rotation latch with any standard knobset, add product code **Latch28** and list price **\$7**
- Designer knobsets may also be ordered with any Modern rosette at the list price shown above.

For more information

- See page 170 for Concealed Fastener (C)
- See pages 130-131 for Interior Mortise (M)

Rope Knob
with Rope Rosette



Lancaster Knob
with Lancaster Rosette



Ribbon & Reed Knob
with Ribbon & Reed Rosette



Belmont Knob
with Rope Rosette



Victoria Knob
with 7" Wilshire Sideplate







Ribbon & Reed Knob
with 7" Wilshire Sideplate



Belmont Knob
with 7" Wilshire Sideplate



ROSETTE	Description	Optional Upgrade	Product Code	Knob Style	Finish	Standard List Price	C List Price	M List Price
	Passage Set	C or M	8101	Belmont Knob (BT) Lancaster Knob (LN) Ribbon & Reed Knob (RBK) Rope Knob (RK) Victoria Knob (V)	Polished Brass - Lifetime (US3) French Antique (US7) Oil Rubbed Bronze (US10B) Satin Nickel (US15) Pewter (US15A) Polished Chrome (US26) Unlacquered Brass (US3NL)*	\$209	\$253	\$409
	Privacy Set	C or M	8201			\$209	\$253	\$409
	Dummy		8051			\$209		
	Passage Set	C or M	8106			\$209	\$253	\$409
	Privacy Set	C or M	8206			\$209	\$253	\$409
	Dummy		8056			\$209		
	Passage Set	C or M	8107			\$209	\$253	\$409
	Privacy Set	C or M	8207			\$209	\$253	\$409
	Dummy		8057			\$209		

SIDEPLATE	Description	Optional Upgrade	Product Code	Knob Style	Finish	Standard List Price	C List Price
	Passage Set	C	8135	Belmont Knob (BT) Lancaster Knob (LN) Ribbon & Reed Knob (RBK) Rope Knob (RK) Victoria Knob (V)	Polished Brass - Lifetime (US3) French Antique (US7) Oil Rubbed Bronze (US10B) Satin Nickel (US15) Pewter (US15A) Polished Chrome (US26) Unlacquered Brass (US3NL)*	\$266	\$310
	Privacy Set	C	8235			\$266	\$310
	Dummy		8035			\$266	

*Unlacquered Brass (US3NL) finish available for a \$20 List Price upcharge per item.

- **Handing Not Required for Knobsets**
- Standard latch is for 2 3/8" backset. Specify 2 3/4" backset if required.
- Complete set includes standard rotation latch and strike plate. Specify Drive-in latch if required.
- Latches come standard with square corner strike and face plates. Specify radius corners if required.
- To order 28° rotation latch with any standard knobset, add product code **Latch28** and list price **\$7**
- Designer knobsets may also be ordered with any Modern rosette at the list price shown above.

For more information
 • See page 170 for Concealed Fastener (C)
 • See pages 130-131 for Interior Mortise (M)

To order: (Optional Upgrade) Product Code + Knob Style + Finish + Add Door Thickness to Comments

Old Town Glass Knob with #8 Rosette



Bristol Glass Knob with Rectangular Rosette



Old Town Glass Knob with Wilshire Rosette



Providence Glass Knob with Quincy Rosette



Georgetown Glass Knob with Wilshire Rosette



Hampton Glass Knob with #8 Rosette









Lowell Glass Knob with Watford Rosette



Windsor Glass Knob with Rectangular Rosette



ROSETTE	Description	Optional Upgrade	Product Code	Glass Knob Style	Finish	Standard List Price	C List Price	M List Price
	Passage Set	C or M	8108	Astoria Knob (AS) Bristol Knob (BL) Diamond Knob (CK) Georgetown Knob (GT) Hampton Knob (HT) Lowell Knob (LW) Old Town Knob (OT) Providence Knob (PC) Windsor Knob (WS)	Polished Brass - Lifetime (US3) Satin Brass (US4) French Antique (US7) Oil Rubbed Bronze (US10B) Polished Nickel - Lifetime (US14) Satin Nickel (US15) Pewter (US15A) Flat Black (US19) Polished Chrome (US26) Unlacquered Brass (US3NL)*	\$209	\$253	\$409
	Privacy Set	C or M	8208			\$209	\$253	\$409
	Dummy		8058			\$209		
	Passage Set	C or M	8120			\$209	\$253	\$409
	Privacy Set	C or M	8220			\$209	\$253	\$409
	Dummy		8520			\$209		
	Passage Set	C or M	8100			\$209	\$253	\$409
	Privacy Set	C or M	8200			\$209	\$253	\$409
	Dummy		8050			\$209		
	Passage Set	C or M	8121			\$209	\$253	\$409
	Privacy Set	C or M	8221			\$209	\$253	\$409
	Dummy		8521			\$209		
	Passage Set	C or M	8131			\$209	\$253	\$409
	Privacy Set	C or M	8231			\$209	\$253	\$409
	Dummy		8531			\$209		
	Passage Set	C or M	8110			\$209	\$253	\$409
	Privacy Set	C or M	8210			\$209	\$253	\$409
	Dummy		8510			\$209		
	Passage Set	C or M	8161	\$209	\$253	\$409		
	Privacy Set	C or M	8261	\$209	\$253	\$409		
	Dummy		8561	\$209				

*Unlacquered Brass (US3NL) finish available for a \$20 List Price upcharge per item.



• **Handing Not Required for Knobsets**

- Standard latch is for 2 3/8" backset. Specify 2 3/4" backset if required.
- Complete set includes standard rotation latch and strike plate. Specify Drive-in latch if required.
- Latches come standard with square corner strike and face plates. Specify radius corners if required.
- To order 28° rotation latch with any standard knobset, add product code **Latch28** and list price **\$7**
- Glass knobsets may also be ordered with any Modern rosette at the list price shown above.

For more information

- See page 170 for **Concealed Fastener (C)**
- See pages 130-131 for **Interior Mortise (M)**

Astoria Glass Knob
with Rope RosetteBristol Glass Knob
with Lancaster RosetteDiamond Glass Knob
with Ribbon & Reed RosetteGeorgetown Glass Knob
with Rope RosetteHampton Glass Knob
with 7" Wilshire SideplateLowell Glass Knob
with 7" Wilshire SideplateOld Town Glass Knob
with 7" Wilshire SideplateWindsor Glass Knob
with 7" Wilshire Sideplate

ROSETTE	Description	Optional Upgrade	Product Code	Glass Knob Style	Finish	Standard List Price	C List Price	IM List Price
	Passage Set	C or M	8101	Astoria Knob (AS)	Polished Brass - Lifetime (US3) French Antique (US7) Oil Rubbed Bronze (US10B) Satin Nickel (US15) Pewter (US15A) Polished Chrome (US26) Unlacquered Brass (US3NL)*	\$209	\$253	\$409
	Privacy Set	C or M	8201	Bristol Knob (BL)		\$209	\$253	\$409
	Dummy		8051	Diamond Knob (CK) Georgetown Knob (GT) Hampton Knob (HT) Lowell Knob (LW)		\$209		
	Passage Set	C or M	8106	Old Town Knob (OT)		\$209	\$253	\$409
	Privacy Set	C or M	8206	Providence Knob (PC)		\$209	\$253	\$409
	Dummy		8056	Windsor Knob (WS)		\$209		
	Passage Set	C or M	8107			\$209	\$253	\$409
	Privacy Set	C or M	8207			\$209	\$253	\$409
	Dummy		8057			\$209		

SIDEPLATE	Description	Optional Upgrade	Product Code	Glass Knob Style	Finish	Standard List Price	C List Price
	Passage Set	C	8135	Astoria Knob (AS)	Polished Brass - Lifetime (US3) Satin Brass (US4) French Antique (US7) Oil Rubbed Bronze (US10B) Polished Nickel - Lifetime (US14) Satin Nickel (US15) Pewter (US15A) Flat Black (US19) Polished Chrome (US26) Unlacquered Brass (US3NL)*	\$266	\$310
	Privacy Set	C	8235	Bristol Knob (BL)		\$266	\$310
	Dummy		8035	Diamond Knob (CK) Georgetown Knob (GT) Hampton Knob (HT) Lowell Knob (LW) Old Town Knob (OT) Providence Knob (PC) Windsor Knob (WS)		\$266	

*Unlacquered Brass (US3NL) finish available for a \$20 List Price upcharge per item.

- **Handing Not Required for Knobsets**
- Standard latch is for 2 $\frac{3}{8}$ " backset. Specify 2 $\frac{3}{4}$ " backset if required.
- Complete set includes standard rotation latch and strike plate. Specify Drive-in latch if required.
- Latches come standard with square corner strike and face plates. Specify radius corners if required.
- To order 28° rotation latch with any standard knobset, add product code **Latch28** and list price **\$7**
- Glass knobsets may also be ordered with any Modern rosette at the list price shown above.

For more information

- See page 170 for Concealed Fastener (C)
- See pages 130-131 for Interior Mortise (M)

To order: (Optional Upgrade) Product Code + Knob Style + Finish + Add Door Thickness to Comments

**Ice White Knob
with Porcelain Rosette**



**Ebony Knob
with Porcelain Rosette**



PORCELAIN ROSETTE		Description	Product Code	Knob Style	Finish (for Center Ring in Rosette)	Standard List Price
	Passage Set	8030	Ebony Knob (EB) Ice White Knob (IW)	Polished Brass - Lifetime (US3) French Antique (US7) Oil Rubbed Bronze (US10B) Satin Nickel (US15) Pewter (US15A) Flat Black (US19) Polished Chrome (US26)	\$165	
	Privacy Set	8040			\$165	
	Dummy	8003			\$165	

>> CF Optional Upgrade NOT available for Porcelain Style Rosettes

**Ebony Knob
with Ribbon & Reed Rosette**



**Ice White Knob
with Rectangular Rosette**



**Ebony Knob
with #8 Brass Rosette**



**Ice White Knob
with 7" Wilshire Sideplate**



BRASS ROSETTES		Optional Upgrade	Product Code	Knob Style	Finish	Standard List Price	C List Price
Passage Set	C	See page 143 - 151 for all Brass Rosette product codes.	Ebony Knob (EB) Ice White Knob (IW)	Polished Brass - Lifetime (US3) Satin Brass (US4) French Antique (US7) Oil Rubbed Bronze (US10B) Polished Nickel - Lifetime (US14) Satin Nickel (US15) Pewter (US15A) Flat Black (US19) Polished Chrome (US26) Unlacquered Brass (US3NL)*	\$165	\$209	
Privacy Set	C				\$165	\$209	
Dummy					\$165		

SIDEPLATE		Optional Upgrade	Product Code	Knob Style	Finish	Standard List Price	C List Price
	Passage Set	C	8135	Ebony Knob (EB) Ice White Knob (IW)	Polished Brass - Lifetime (US3) Satin Brass (US4) French Antique (US7) Oil Rubbed Bronze (US10B) Polished Nickel - Lifetime (US14) Satin Nickel (US15) Pewter (US15A) Flat Black (US19) Polished Chrome (US26) Unlacquered Brass (US3NL)*	\$266	\$310
	Privacy Set	C	8235			\$266	\$310
	Dummy		8035			\$266	

*Unlacquered Brass (US3NL) finish available for a \$20 List Price upcharge per item.

- **Handing Not Required for Knobsets**
- Standard latch is for 2¾" backset. Specify 2¾" backset if required.
- Complete set includes standard rotation latch and strike plate. Specify Drive-in latch if required.
- Latches come standard with square corner strike and face plates. Specify radius corners if required.
- To order 28° rotation latch with any standard knobset, add product code **Latch28** and list price **\$7**
- Complete set includes standard rotation latch and strike plate.



For more information
• See page 170 for Concealed Fastener (C)

**Arts & Crafts Lever
with Arts & Crafts Rosette**



**Hammered Lever
with Hammered Rosette**





ROSETTE	Description	Optional Upgrade	Product Code	Lever Style	Finish	Standard List Price	C List Price	M List Price
Arts & Crafts 	Passage Set	C or M	5105	Arts & Crafts Lever (AC) Hammered Lever (HM)	Oil Rubbed Bronze (US10B) Satin Nickel (US15) Flat Black (US19) Unlacquered Brass (US3NL)*	\$209	\$260	\$409
	Privacy Set	C or M	5205			\$209	\$260	\$409
	Dummy		5055			\$209		
Hammered 	Passage Set	C or M	5106			\$209	\$260	\$409
	Privacy Set	C or M	5206			\$209	\$260	\$409
	Dummy		5056			\$209		

**Hammered Egg Knob
with Arts & Crafts Rosette**



**Hammered Egg Knob
with Hammered Rosette**



ROSETTE	Description	Optional Upgrade	Product Code	Knob Style	Finish	Standard List Price	C List Price	M List Price
Arts & Crafts 	Passage Set	C or M	5105	Hammered Egg Knob (HE)	Oil Rubbed Bronze (US10B) Satin Nickel (US15) Flat Black (US19) Unlacquered Brass (US3NL)*	\$209	\$253	\$409
	Privacy Set	C or M	5205			\$209	\$253	\$409
	Dummy		5055			\$209		
Hammered 	Passage Set	C or M	5106			\$209	\$253	\$409
	Privacy Set	C or M	5206			\$209	\$253	\$409
	Dummy		5056			\$209		

*Unlacquered Brass (US3NL) finish available for a \$20 List Price upcharge per item.

• Handing Required for Leversets

- Standard latch is for 2 3/8" backset. Specify 2 3/4" backset if required.
- Complete set includes standard rotation latch and strike plate. Specify Drive-in latch if required.
- Latches come standard with square corner strike and face plates. Specify radius corners if required.
- To order 28° rotation latch with any standard knobset/lever set, add product code **Latch28** and list price **\$7**
- Arts & Crafts leversets/knobsets may also be ordered with any Modern or Brass rosette at the list price shown above.

For more information

- See page 170 for Concealed Fastener (C)
- See pages 130-131 for Interior Mortise (M)

To order: (Optional Upgrade) Product Code + Knob/Lever Style + Handing + Finish + Add Door Thickness to Comments

THUMBTURN PRIVACY BOLTS - USE WITH BRASS PASSAGE SET



THUMBTURN PRIVACY BOLTS	Product Code	Finish	List Price
Disk	8682	Polished Brass - Lifetime (US3) Satin Brass (US4) French Antique (US7) Oil Rubbed Bronze (US10B) Polished Nickel - Lifetime (US14) Satin Nickel (US15) Pewter (US15A)	\$78
Square	8582	Flat Black (US19) Polished Chrome (US26) Unlacquered Brass (US3NL)*	\$78
Watford	8482		\$78
Wilshire	8382		\$78
Classic	828TP	Polished Brass - Lifetime (US3) Satin Brass (US4) French Antique (US7) Oil Rubbed Bronze (US10B) Polished Nickel - Lifetime (US14) Satin Nickel (US15) Pewter (US15A) Flat Black (US19) Polished Chrome (US26) Unlacquered Brass (US3NL)*	\$52
Modern	818TP	Satin Brass (US4) Oil Rubbed Bronze (US10B) Polished Nickel - Lifetime (US14) Satin Nickel (US15) Flat Black (US19) Polished Chrome (US26) Unlacquered Brass (US3NL)*	\$52

>> See pages 138-139 for more Mix-Match style options.

- **Handing Required for Leversets. Knob/Lever Lockset sold separately.**
- Fits door thickness 1 $\frac{3}{8}$ " to 1 $\frac{3}{4}$ ". Specify if thicker.
- Standard latch is for 2 $\frac{3}{8}$ " backset. Specify 2 $\frac{3}{4}$ " backset if required.
- Complete set includes latch, strike plate and emergency release tool.
- Thumbturn privacy bolt only available with square corner latch face plate.
- Thumbturn privacy bolt can be used with any Brass passage set.

*Unlacquered Brass (US3NL) finish available for a \$10 List Price upcharge per item.

**Cologne Lever
with Disk Rosette**



**Dresden Lever
with Square Rosette**



**Stuttgart Lever
with Disk Rosette**



TUBULAR STAINLESS STEEL LEVERSETS	Optional Upgrade	Product Code	Rosette Style	Lever Style	Finish	Standard List Price	C List Price
Passage Set	C	S100	Disk (02) Square (03)	Cologne Lever (CO)	Brushed Stainless Steel (SS)	\$165	\$216
Privacy Set	C	S200		Dresden Lever (DD)			
Dummy		S300		Kiel Lever (KL) Stuttgart Lever (STT)			

**Poseidon Lever
with Disk Rosette**



**Hercules Lever
with Disk Rosette**



**Helios Lever
with Square Rosette**



CAST STAINLESS STEEL LEVERSETS	Optional Upgrade	Product Code	Rosette Style	Lever Style	Finish	Standard List Price	C List Price
Passage Set	C	S100	Disk (02) Square (03)	Athena Lever (AT)	Brushed Stainless Steel (SS)	\$209	\$260
Privacy Set	C	S200		Hercules Lever (HS)			
Dummy		S300		Helios Lever (HL) Hermes Lever (HES) Poseidon Lever (PO)			

**Round Knob
with Disk Rosette**



**Octagon Knob
with Square Rosette**



CAST STAINLESS STEEL KNOBSETS	Optional Upgrade	Product Code	Rosette Style	Knob Style	Finish	Standard List Price	C List Price
Passage Set	C	S100	Disk (02) Square (03)	Octagon Knob (OK)	Brushed Stainless Steel (SS)	\$209	\$253
Privacy Set	C	S200		Round Knob (RNK)			
Dummy		S300					

• Handing Required for Leversets

- Standard latch is for 2 3/8" backset. Specify 2 3/4" backset if required.
- Supplied with a 28° rotation latch for Leversets, standard rotation latch for Knobsets.
- Complete set includes standard rotation latch and strike plate. Specify Drive-in latch if required.
- Latches come standard with square corner strike and face plates. Specify radius corners if required.

For more information
• See page 170 for Concealed Fastener (C)

Yuma Lever with #6 Rosette



Durango Lever with #1 Rosette



Montrose Lever with #3 Rosette



Cody Lever with #2 Rosette



Lariat Lever with #4 Rosette



Teton Lever with #4 Rosette



Cimarron Lever with #2 Rosette



Aurora Lever with #6 Rosette







Bryce Lever with #3 Rosette

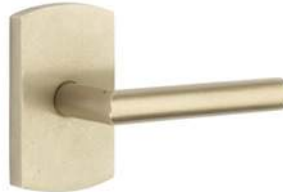

Mariposa Lever with #4 Rosette



ROSETTE	Description	Optional Upgrade	Product Code	Lever Style	Finish	Standard List Price	C List Price
#1 	Passage Set	C	7108	Aurora Lever (AR) Bryce Lever (BR) Cimarron Lever (CR) Cody Lever (CD) Durango Lever (D) Lariat Lever (LR) Mariposa Lever (MA) Montrose Lever (MT) Teton Lever (TT) Yuma Lever (YM)	Flat Black Bronze (FB) Medium Bronze (MB) Tumbled White Bronze (TWB)	\$239	\$290
	Privacy Set	C	7208			\$239	\$290
	Dummy		7058			\$239	
	Passage Set	C	7106			\$239	\$290
#2 	Privacy Set	C	7206			\$239	\$290
	Dummy		7056			\$239	
	Passage Set	C	7104			\$239	\$290
#3 	Privacy Set	C	7204			\$239	\$290
	Dummy		7054			\$239	
	Passage Set	C	7100			\$239	\$290
#4 	Privacy Set	C	7200			\$239	\$290
	Dummy		7050			\$239	
	Passage Set	C	7111	\$239	\$290		
#6 	Privacy Set	C	7211	\$239	\$290		
	Dummy		7061	\$239			

• **Handing Required for Leversets**

- Standard latch is for 2³/₈" backset. Specify 2³/₄" backset if required.
- To order 28° rotation latch with any standard leverset, add product code **Latch28** and list price **\$7**
- Complete set includes standard rotation latch and strike plate. Specify Drive-in latch if required.
- Latches come standard with square corner strike and face plates. Specify radius corners if required.

For more information
• See page 170 for Concealed Fastener (C)

Butte Knob
with #4 Rosette



Round Knob
with #6 Rosette



Winchester Knob
with #3 Rosette



Egg Knob
with #2 Rosette



Butte Knob
with #1 Rosette



Winchester Knob
with #2 Rosette







Egg Knob
with #4 Rosette



Round Knob
with #6 Rosette



ROSETTE	Description	Optional Upgrade	Product Code	Knob Style	Finish	Standard List Price	C List Price
#1 	Passage Set	C	7108	Butte Knob (BU) Egg Knob (BZEG) Round Knob (BZRN) Winchester Knob (WC)	Flat Black Bronze (FB) Medium Bronze (MB) Tumbled White Bronze (TWB)	\$239	\$283
	Privacy Set	C	7208			\$239	\$283
	Dummy		7058			\$239	
#2 	Passage Set	C	7106			\$239	\$283
	Privacy Set	C	7206			\$239	\$283
	Dummy		7056			\$239	
#3 	Passage Set	C	7104			\$239	\$283
	Privacy Set	C	7204			\$239	\$283
	Dummy		7054			\$239	
#4 	Passage Set	C	7100			\$239	\$283
	Privacy Set	C	7200			\$239	\$283
	Dummy		7050			\$239	
#6 	Passage Set	C	7111			\$239	\$283
	Privacy Set	C	7211			\$239	\$283
	Dummy		7061			\$239	

• **Handing Not Required for Knobsets**

- Standard latch is for 2 3/8" backset. Specify 2 3/4" backset if required.
- To order 28° rotation latch with any standard knobset, add product code **Latch28** and list price **\$7**
- Complete set includes standard rotation latch and strike plate. Specify Drive-in latch if required.
- Latches come standard with square corner strike and face plates. Specify radius corners if required.

For more information
• See page 170 for Concealed Fastener (C)

Astoria Glass Knob
with #6 Rosette



Bristol Glass Knob
with #2 Rosette



Diamond Glass Knob
with #3 Rosette



Georgetown Glass Knob
with #4 Rosette



Hampton Glass Knob
with #1 Rosette



Lowell Glass Knob
with #4 Rosette



ROSETTE	Description	Optional Upgrade	Product Code	Glass Knob Style	Finish	Standard List Price	C List Price
#1 	Passage Set	C	7108	Astoria Knob (AS) Bristol Knob (BL) Diamond Knob (CK) Georgetown Knob (GT) Hampton Knob (HT) Lowell Knob (LW)	Flat Black Bronze (FB) Medium Bronze (MB) Tumbled White Bronze (TWB)	\$239	\$283
	Privacy Set	C	7208			\$239	\$283
	Dummy		7058			\$239	
#2 	Passage Set	C	7106			\$239	\$283
	Privacy Set	C	7206			\$239	\$283
	Dummy		7056			\$239	
#3 	Passage Set	C	7104			\$239	\$283
	Privacy Set	C	7204			\$239	\$283
	Dummy		7054			\$239	
#4 	Passage Set	C	7100			\$239	\$283
	Privacy Set	C	7200			\$239	\$283
	Dummy		7050			\$239	
#6 	Passage Set	C	7111			\$239	\$283
	Privacy Set	C	7211			\$239	\$283
	Dummy		7061			\$239	

• **Handing Not Required for Knobsets**

- Standard latch is for 2¾" backset. Specify 2¾" backset if required.
- To order 28° rotation latch with any standard knobset, add product code **Latch28** and list price **\$7**
- Complete set includes standard rotation latch and strike plate. Specify Drive-in latch if required.
- Latches come standard with square corner strike and face plates. Specify radius corners if required.

For more information
• See page 170 for Concealed Fastener (C)

Modern Disc Glass Knob with #6 Rosette



Modern Square Glass Knob with #3 Rosette



Old Town Glass Knob with #1 Rosette



Providence Glass Knob with #3 Rosette







Windsor Glass Knob with #1 Rosette



Providence Glass Knob with #2 Rosette



ROSETTE	Description	Optional Upgrade	Product Code	Glass Knob Style	Finish	Standard List Price	C List Price
#1 	Passage Set	C	7108	Modern Disc Knob (MDC) Modern Square Knob (MSC) Old Town Knob (OT) Providence Knob (PC) Windsor Knob (WS)	Flat Black Bronze (FB) Medium Bronze (MB) Tumbled White Bronze (TWB)	\$239	\$283
	Privacy Set	C	7208			\$239	\$283
	Dummy		7058			\$239	
	Passage Set	C	7106			\$239	\$283
#2 	Privacy Set	C	7206			\$239	\$283
	Dummy		7056			\$239	
	Passage Set	C	7104			\$239	\$283
Privacy Set	C	7204					
Dummy		7054					
#3 	Passage Set	C	7100			\$239	\$283
	Privacy Set	C	7200				
	Dummy		7050				
#4 	Passage Set	C	7111	\$239	\$283		
	Privacy Set	C	7211				
	Dummy		7061				
#6 	Passage Set	C	7111	\$239	\$283		
	Privacy Set	C	7211				
	Dummy		7061				

- **Handing Not Required for Knobsets**
- Standard latch is for 2 3/8" backset. Specify 2 3/4" backset if required.
- To order 28° rotation latch with any standard knobset, add product code **Latch28** and list price **\$7**
- Complete set includes standard rotation latch and strike plate. Specify Drive-in latch if required.
- Latches come standard with square corner strike and face plates. Specify radius corners if required.

For more information
• See page 170 for Concealed Fastener (C)

Medici Lever
with #14 Rosette



Napoli Lever
with #12 Rosette



Octagon Lever
with #11 Rosette



Padua Lever
with #11 Rosette







Octagon Lever
with #15 Rosette



Medici Lever
with #12 Rosette



ROSETTE	Description	Optional Upgrade	Product Code	Lever Style	Finish	Standard List Price	C List Price
	Passage Set	C	71011	Medici Lever (MDI) Napoli Lever (NA) Octagon Lever (OCL)* Padua Lever (PD)	Flat Black Bronze (FB) Medium Bronze (MB)	\$239	\$290
	Privacy Set	C	72011			\$239	\$290
	Dummy		70511			\$239	
	Passage Set	C	71012			\$239	\$290
	Privacy Set	C	72012			\$239	\$290
	Dummy		70512			\$239	
	Passage Set		71014			\$239	
	Privacy Set		72014			\$239	
	Dummy		70514			\$239	
	Passage Set	C	71015			\$239	\$290
	Privacy Set	C	72015			\$239	\$290
	Dummy		70515			\$239	

*#14 Rosette and Octagon Lever **NOT** available with CF .

• **Handing Required for Leversets**

- Standard latch is for 2¾" backset. Specify 2¾" backset if required.
- To order 28° rotation latch with any standard leverset, add product code **Latch28** and list price **\$7**
- Complete set includes standard rotation latch and strike plate. Specify Drive-in latch if required.
- Latches come standard with square corner strike and face plates. Specify radius corners if required.

For more information
• See page 170 for Concealed Fastener (C)

Petal Knob
with #12 Rosette



Octagon Knob
with #11 Rosette



Parma Knob
with #14 Rosette



Octagon Knob
with #15 Rosette







Parma Knob
with #12 Rosette



Petal Knob
with #11 Rosette



ROSETTE	Description	Optional Upgrade	Product Code	Knob Style	Finish	Standard List Price	C List Price
	Passage Set	C	71011	Octagon Knob (OCK) Parma Knob (PA) Petal Knob (PT)	Flat Black Bronze (FB) Medium Bronze (MB)	\$239	\$283
	Privacy Set	C	72011			\$239	\$283
	Dummy		70511			\$239	
	Passage Set	C	71012			\$239	\$283
	Privacy Set	C	72012			\$239	\$283
	Dummy		70512			\$239	
	Passage Set		71014			\$239	
	Privacy Set		72014			\$239	
	Dummy		70514			\$239	
	Passage Set	C	71015			\$239	\$283
	Privacy Set	C	72015			\$239	\$283
	Dummy		70515			\$239	

*#14 Rosette **NOT** available with CF .

• Handing Not Required for Knobsets

- Standard latch is for 2 3/8" backset. Specify 2 3/4" backset if required.
- To order 28° rotation latch with any standard knobset, add product code **Latch28** and list price **\$7**
- Complete set includes standard rotation latch and strike plate. Specify Drive-in latch if required.
- Latches come standard with square corner strike and face plates. Specify radius corners if required.

For more information
• See page 170 for **Concealed Fastener (C)**

To order: **(Optional Upgrade) Product Code + Knob Style + Finish + Add Door Thickness to Comments**

San Carlos Lever
with #2 Rosette



Normandy Lever
with #2 Rosette



San Carlos Lever
with #3 Rosette



Lafayette Lever
with #1 Rosette





San Carlos Lever
with #1 Rosette



Lafayette Lever
with #3 Rosette



ROSETTE	Description	Product Code	Lever Style	Finish	Standard List Price
	Passage Set	7101	Lafayette Lever (L) Normandy Lever (N) San Carlos Lever (SC)	Flat Black Steel (FBS) Satin Steel (SWS)	\$165
	Privacy Set	7201			\$165
	Dummy	7051			\$165
	Passage Set	7102			\$165
	Privacy Set	7202			\$165
	Dummy	7052			\$165
	Passage Set	7103			\$165
	Privacy Set	7203			\$165
	Dummy	7053			\$165

• Handing Required for Leversets

- Standard latch is for 2¾" backset. Specify 2¾" backset if required.
- To order 28° rotation latch with any standard leverset, add product code **Latch28** and list price **\$7**
- Complete set includes standard rotation latch and strike plate. Specify Drive-in latch if required.
- Latches come standard with square corner strike and face plates. Specify radius corners if required.

CF Optional Upgrade NOT available for Wrought Steel products.

Savannah Knob
with #3 Rosette



Madison Ivory Knob
with #1 Rosette



Jamestown Knob
with #1 Rosette



Jamestown Knob
with #3 Rosette



Savannah Knob
with #1 Rosette



Madison Black Knob
with #2 Rosette



ROSETTE	Description	Product Code	Knob Style	Finish	Standard List Price
	Passage Set	7101	Jamestown Knob (J) Madison Black Knob (MB) Madison Ivory Knob (MI) Savannah Knob (SV)	Flat Black Steel (FBS) Satin Steel (SWS)	\$165
	Privacy Set	7201			\$165
	Dummy	7051			\$165
	Passage Set	7102			\$165
	Privacy Set	7202			\$165
	Dummy	7052			\$165
	Passage Set	7103			\$165
	Privacy Set	7203			\$165
	Dummy	7053			\$165

• Handing Not Required for Knobsets

- Standard latch is for 2³/₄" backset. Specify 2³/₄" backset if required.
- To order 28° rotation latch with any standard knobset, add product code **Latch28** and list price **\$7**
- Complete set includes standard rotation latch and strike plate. Specify Drive-in latch if required.
- Latches come standard with square corner strike and face plates. Specify radius corners if required.

CF Optional Upgrade NOT available for Wrought Steel products.



Standard Latch

- Exposed screws on interior rosette
- Standard rotation latch

How To Order:

5110	HLO	US15	RH
Product Code	Lever/Knob	Finish	Handing



28° Rotation Latch Upgrade

- Exposed screws on interior rosette
- Requires less rotation than standard latch

How To Order:

5110	HLO	US15	RH	Latch28
Product Code	Lever/Knob	Finish	Handing	28° rotation latch



Concealed Fastener Upgrade

- Rosettes have no exposed screws.
- Handing not required except for split style and/or finish.
- Door thickness is 1 3/8" to 1 3/4". Specify if thicker.
- Supplied with dust box and a 28° rotation latch for Leversets, standard rotation latch for Knobset

How To Order:

C	5110	HLO	US15
Concealed Fastener Code	Product Code	Lever/Knob	Finish



Modern Rectangular Barn Door Privacy Lock with Strike



1" x 3 1/4" 2 1/2" x 7"

Modern Rectangular Barn Door Privacy Lock and Flush Pull with Integrated Strike

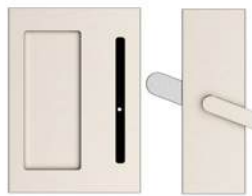

5" x 7" 2 1/2" x 7"

Modern Rectangular Barn Door Privacy Lock and Narrow Flush Pull with Integrated Strike



2 1/2" x 7" 2 1/2" x 7"

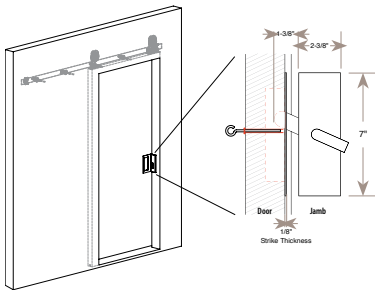

Mounts to Interior Side of the Door & Jamb

- Handing NOT Required
- 1 3/8" Minimum for Door Thickness
- Solid Brass Material
- Includes Emergency Release Tool
- Patent Pending

BARN DOOR PRIVACY LOCKS	Product Code	Finish	List Price
Modern Rectangular Barn Door Privacy Lock with Strike	222201	Satin Brass (US4) Oil Rubbed Bronze (US10B) Polished Nickel (US14) Satin Nickel (US15)	\$138
Modern Rectangular Barn Door Privacy Lock and Flush Pull with Integrated Strike	222202	Flat Black (US19) Polished Chrome (US26) Unlacquered Brass (US3NL)*	\$229
Modern Rectangular Barn Door Privacy Lock and Narrow Flush Pull with Integrated Strike	222203		\$229

*Unlacquered Brass (US3NL) finish available for a \$20 List Price upcharge per item.



BARN DOOR KIT CONTENTS

- Pair of hangers with wheels attached
- Track mounting hardware kit
 - Track Screws
 - Posts with 3 spacers
 - Anti-crush plastic spacers for 1/2" & 5/8" thick drywall
- Adjustable track stops
- Floor guide
- Length of track
- Anti-jump mechanism
- Soft open/close kit (Optional)



Available Lengths:
5', 6'6", 8', 10', 13', 16'

Optional: Soft Open/Close

Low Profile Concealed Wheel - Steel

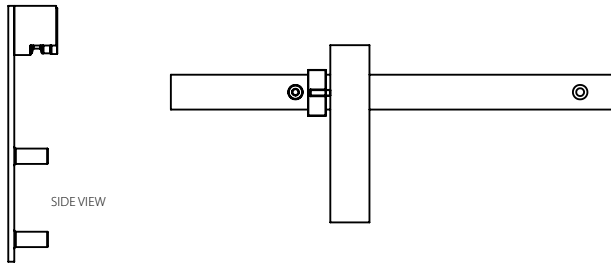

TRACK LENGTH	Product Code	Finish	Double Door Option	List Price
5'	B130305	Flat Black (US19)	For additional hanger kit, add product code DD and list price \$409 Kit Includes: 1 Pair of Hangers with Wheels, Stops, Fasteners, Anti-jump Mechanism & Floor Guide	\$782
6'-6"	B130306			\$841
8'	B130308			\$898
10'*	B130310			\$1192
13'*	B130313			\$1296
16'*	B130316			\$1411
SOFT OPEN/CLOSE KIT	BSC001	Must order 2 kits to have soft open and close .		\$83 (each)

* Uses 2 track lengths connected with a splice.

Low Profile Concealed Wheel - Stainless Steel

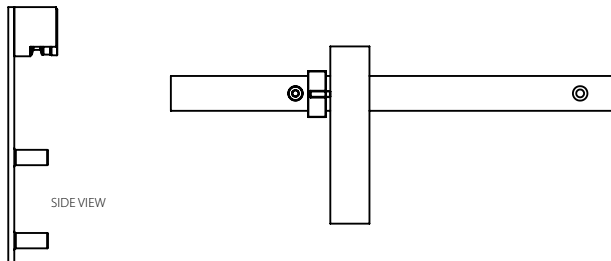

TRACK LENGTH	Product Code	Finish	Double Door Option	List Price
5'	B130305	Brushed Stainless Steel (SS)	For additional hanger kit, add product code DD and list price \$736 Kit Includes: 1 Pair of Hangers with Wheels, Stops, Fasteners, Anti-jump Mechanism & Floor Guide	\$1330
6'-6"	B130306			\$1444
8'	B130308			\$1575
10'*	B130310			\$1969
13'*	B130313			\$2195
16'*	B130316			\$2464
SOFT OPEN/CLOSE KIT	BSC001	Must order 2 kits to have soft open and close .		\$83 (each)

* Uses 2 track lengths connected with a splice.

FLAT TRACK SLIDING BARN DOOR HARDWARE



Modern Rectangular Face Mount Solid Wheel
Brushed Stainless Steel (SS)



Classic Face Mount Solid Wheel
Oil Rubbed Bronze (US10B)



Modern Rectangular Top Mount Spoked Wheel
Flat Black (US19)



Classic Top Mount Spoked Wheel
Brushed Stainless Steel (SS)

BARN DOOR KIT CONTENTS

- Pair of hangers with wheels attached
- Hanger fasteners
- Track mounting hardware kit
 - Track Screws
 - Posts with 3 spacers
 - Anti-crush plastic spacers for 1/2" & 5/8" thick drywall
- Adjustable track stops
- Floor guide
- Length of track
- Anti-jump mechanism
- Soft open/close kit (Optional)



Track & Hanger Fasteners Flat



Track & Hanger Fasteners Classic



Available Lengths:
5', 6'6", 8', 10', 13', 16'

Optional: Soft Open/Close

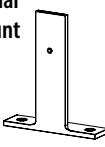
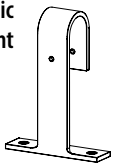
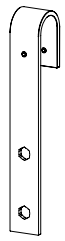
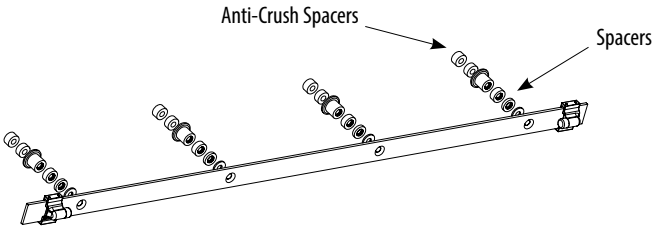
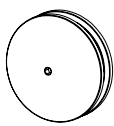
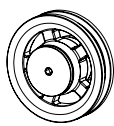
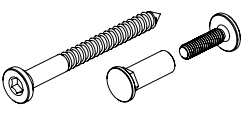
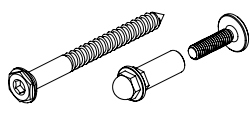
HOW TO ORDER

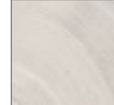
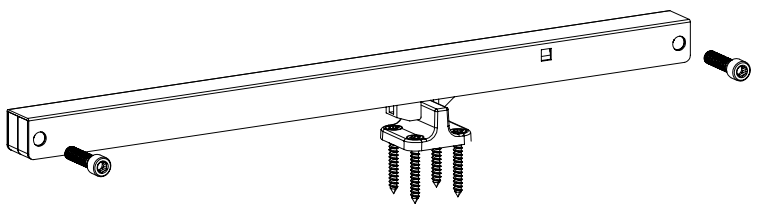



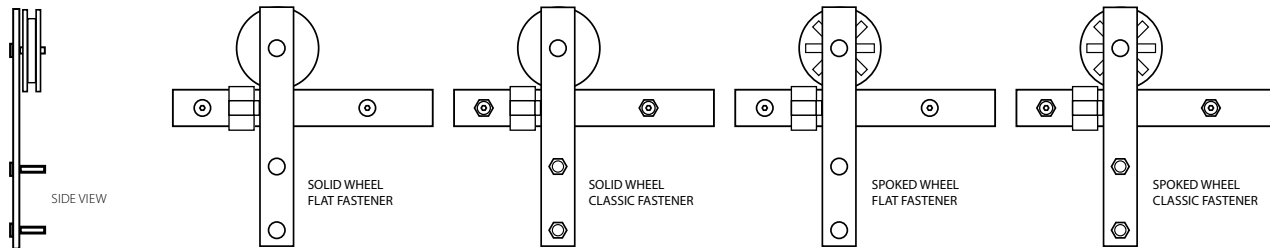

<p>1 CHOOSE YOUR HANGER STYLE</p>	<div style="display: flex; justify-content: space-around; align-items: flex-start;"> <div style="text-align: center;"> <p>Modern Rectangular Face Mount</p>  </div> <div style="text-align: center;"> <p>Modern Rectangular Top Mount</p>  </div> <div style="text-align: center;"> <p>Classic Top Mount</p>  </div> <div style="text-align: center;"> <p>Classic Face Mount</p>  </div> </div>
<p>2 SELECT YOUR TRACK LENGTH</p>	<ul style="list-style-type: none"> • 5 ft • 6 ft 6 in • 8 ft • 10 ft • 13 ft • 16 ft <div style="text-align: center;">  </div>
<p>3 CHOOSE YOUR WHEEL STYLE</p>	<div style="display: flex; justify-content: space-around; align-items: center;"> <div style="text-align: center;"> <p>Solid (SD)</p>  </div> <div style="text-align: center;"> <p>Spoked (SP)</p>  </div> </div> <p style="text-align: center;">Features Quiet Glide Nylon Insert</p>
<p>4 CHOOSE YOUR FASTENER STYLE</p>	<div style="display: flex; justify-content: space-around; align-items: center;"> <div style="text-align: center;"> <p>Flat (FT)</p>  <p>Track Hanger</p> </div> <div style="text-align: center;"> <p>Classic (CL)</p>  <p>Track Hanger</p> </div> </div>
<p>5 PICK YOUR FINISH</p>	<div style="display: flex; justify-content: space-around; align-items: center;"> <div style="text-align: center;">  <p>Oil Rubbed Bronze (US10B)</p> </div> <div style="text-align: center;">  <p>Flat Black (US19)</p> </div> <div style="text-align: center;">  <p>Brushed Stainless Steel (SS)</p> </div> </div>
<p>6 OPTIONAL SOFT OPEN/CLOSE</p>	

Product Code: **B110105 . SD . FT . US19** + Add Double Door (DD) to Comments

Product Code + Wheel Style + Fastener Style + Finish
 Hanger Style/Track Length Style Style

Modern Rectangular Face Mount Hanger





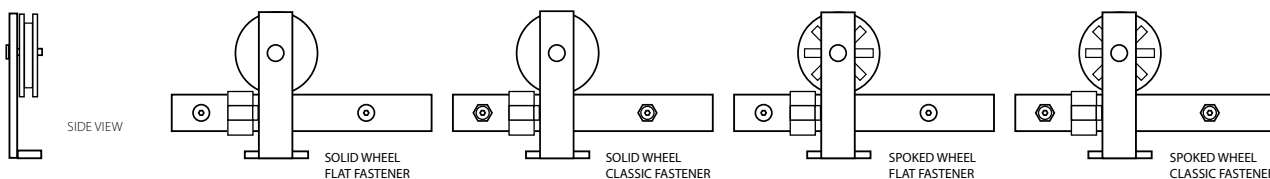

TRACK LENGTH	Product Code	Wheel Style	Fastener Style	Finish	Double Door Option	List Price
5'	B110105	Solid (SD) 	Flat (FT)  	Oil Rubbed Bronze (US10B) Flat Black (US19)	For additional hanger kit, add product code DD and list price \$409 Kit Includes: 1 Pair of Hangers with Wheels, Stops, Fasteners, Anti-jump Mechanism & Floor Guide	\$782
6'-6"	B110106					\$841
8'	B110108					\$898
10' [*]	B110110	Spoked (SP) 	Classic (CL)  			\$1192
13' [*]	B110113					\$1296
16' [*]	B110116					\$1411
SOFT OPEN/CLOSE KIT	BSC001	Must order 2 kits to have soft open and close .				\$83 (each)

* Uses 2 track lengths connected with a splice.

Modern Rectangular Top Mount Hanger







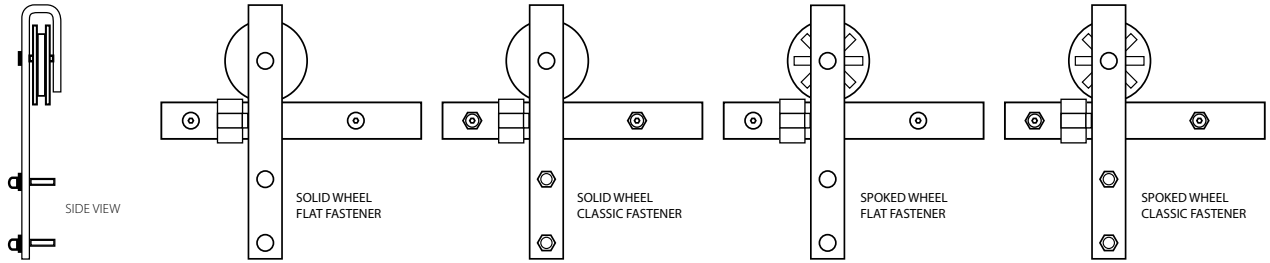

TRACK LENGTH	Product Code	Wheel Style	Fastener Style	Finish	Double Door Option	List Price
5'	B120105	Solid (SD) 	Flat (FT) 	Oil Rubbed Bronze (US10B) Flat Black (US19)	For additional hanger kit, add product code DD and list price \$409 Kit Includes: 1 Pair of Hangers with Wheels, Stops, Fasteners, Anti-jump Mechanism & Floor Guide	\$782
6'-6"	B120106					\$841
8'	B120108					\$898
10' [*]	B120110	Spoked (SP) 	Classic (CL) 			\$1192
13' [*]	B120113					\$1296
16' [*]	B120116					\$1411
SOFT OPEN/CLOSE KIT	BSC001	Must order 2 kits to have soft open and close .				\$83 (each)

* Uses 2 track lengths connected with a splice.

Classic Face Mount Hanger





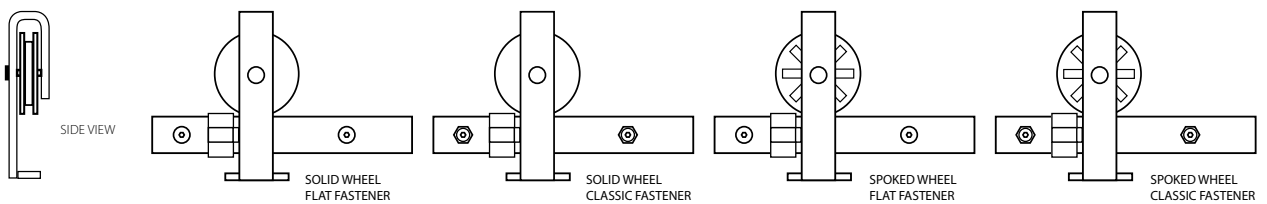

TRACK LENGTH	Product Code	Wheel Style	Fastener Style	Finish	Double Door Option	List Price
5'	B110205	Solid (SD) 	Flat (FT)  	Oil Rubbed Bronze (US10B) Flat Black (US19)	For additional hanger kit, add product code DD and list price \$409 Kit Includes: 1 Pair of Hangers with Wheels, Stops, Fasteners, Anti-jump Mechanism & Floor Guide	\$782
6'-6"	B110206					\$841
8'	B110208	\$898				
10 [*]	B110210	Spoked (SP) 	Classic (CL)  			\$1192
13 [*]	B110213					\$1296
16 [*]	B110216					\$1411
SOFT OPEN/CLOSE KIT	BSC001	Must order 2 kits to have soft open and close .				\$83 (each)

* Uses 2 track lengths connected with a splice.

Classic Top Mount Hanger



TRACK LENGTH	Product Code	Wheel Style	Fastener Style	Finish	Double Door Option	List Price
5'	B120205	Solid (SD) 	Flat (FT) 	Oil Rubbed Bronze (US10B) Flat Black (US19)	For additional hanger kit, add product code DD and list price \$409 Kit Includes: 1 Pair of Hangers with Wheels, Stops, Fasteners, Anti-jump Mechanism & Floor Guide	\$782
6'-6"	B120206					\$841
8'	B120208	\$898				
10 [*]	B120210	Spoked (SP) 	Classic (CL) 			\$1192
13 [*]	B120213					\$1296
16 [*]	B120216					\$1411
SOFT OPEN/CLOSE KIT	BSC001	Must order 2 kits to have soft open and close .				\$83 (each)

* Uses 2 track lengths connected with a splice.

FLAT TRACK SLIDING BARN DOOR HARDWARE - STAINLESS STEEL

Modern Rectangular Face Mount Hanger

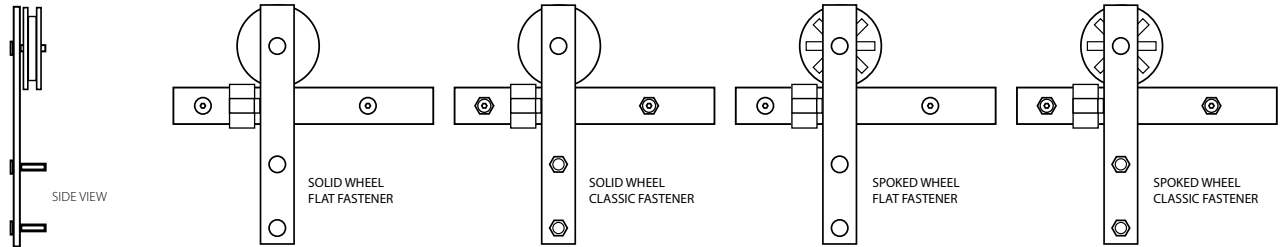

TRACK LENGTH	Product Code	Wheel Style	Fastener Style	Finish	Double Door Option	List Price
5'	B110105	Solid (SD)	Flat (FT) Hanger Track	Brushed Stainless Steel (SS)	For additional hanger kit, add product code DD and list price \$736 Kit Includes: 1 Pair of Hangers with Wheels, Stops, Fasteners, Anti-jump Mechanism & Floor Guide	\$1330
6'-6"	B110106					\$1444
8'	B110108	\$1575				
10 ^{1/2} '	B110110	Spoked (SP)	Classic (CL) Hanger Track			\$1969
13 ^{1/2} '	B110113					\$2195
16 ^{1/2} '	B110116					\$2464
SOFT OPEN/CLOSE KIT	BSC001	Must order 2 kits to have soft open and close .				\$83 (each)

* Uses 2 track lengths connected with a splice.

Modern Rectangular Top Mount Hanger

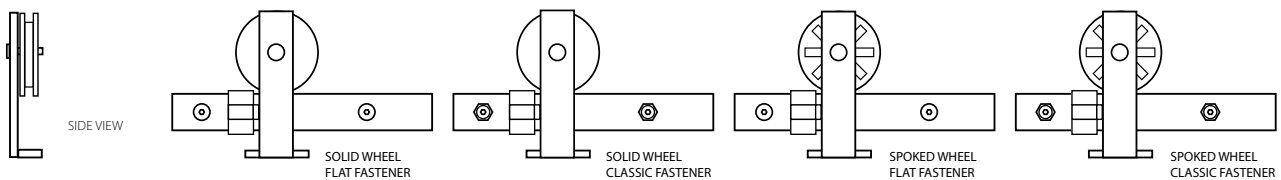

TRACK LENGTH	Product Code	Wheel Style	Fastener Style	Finish	Double Door Option	List Price
5'	B120105	Solid (SD)	Flat (FT) Track	Brushed Stainless Steel (SS)	For additional hanger kit, add product code DD and list price \$736 Kit Includes: 1 Pair of Hangers with Wheels, Stops, Fasteners, Anti-jump Mechanism & Floor Guide	\$1330
6'-6"	B120106					\$1444
8'	B120108	\$1575				
10 ^{1/2} '	B120110	Spoked (SP)	Classic (CL) Track			\$1969
13 ^{1/2} '	B120113					\$2195
16 ^{1/2} '	B120116					\$2464
SOFT OPEN/CLOSE KIT	BSC001	Must order 2 kits to have soft open and close .				\$83 (each)

* Uses 2 track lengths connected with a splice.

Classic Face Mount Hanger

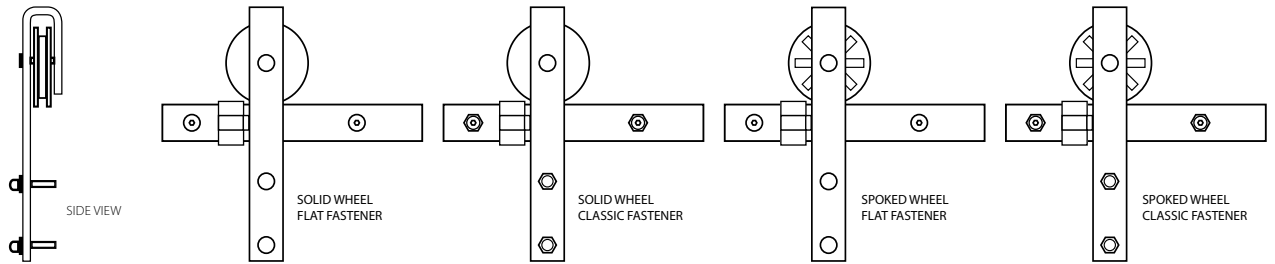

TRACK LENGTH	Product Code	Wheel Style	Fastener Style	Finish	Double Door Option	List Price
5'	B110205	Solid (SD)	Flat (FT)	Brushed Stainless Steel (SS)	For additional hanger kit, add product code DD and list price \$736 Kit Includes: 1 Pair of Hangers with Wheels, Stops, Fasteners, Anti-jump Mechanism & Floor Guide	\$1330
6'-6"	B110206					\$1444
8'	B110208	\$1575				
10 ^{*6}	B110210	Spoked (SP)	Classic (CL)			\$1969
13 ^{*6}	B110213					\$2195
16 ^{*6}	B110216					\$2464
SOFT OPEN/CLOSE KIT	BSC001	Must order 2 kits to have soft open and close .				\$83 (each)

* Uses 2 track lengths connected with a splice.

Classic Top Mount Hanger

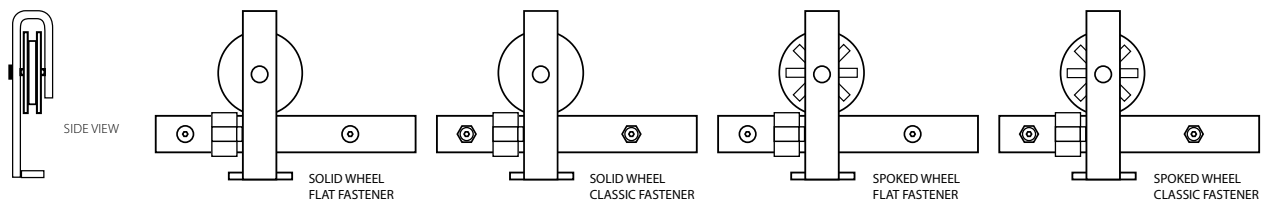

TRACK LENGTH	Product Code	Wheel Style	Fastener Style	Finish	Double Door Option	List Price
5'	B120205	Solid (SD)	Flat (FT)	Brushed Stainless Steel (SS)	For additional hanger kit, add product code DD and list price \$736 Kit Includes: 1 Pair of Hangers with Wheels, Stops, Fasteners, Anti-jump Mechanism & Floor Guide	\$1330
6'-6"	B120206					\$1444
8'	B120208	\$1575				
10 ^{*6}	B120210	Spoked (SP)	Classic (CL)			\$1969
13 ^{*6}	B120213					\$2195
16 ^{*6}	B120216					\$2464
SOFT OPEN/CLOSE KIT	BSC001	Must order 2 kits to have soft open and close .				\$83 (each)

* Uses 2 track lengths connected with a splice.





24" & 36" DOOR PULLS		Optional Mounting	Product Code	Finish	List Price	Back-to-Back List Price
Square	24" Door Pull	CS or BTB	86191	Flat Black (US19) Brushed Stainless Steel (SS) Satin Brass Stainless Steel - Lifetime (SSPVD4) Polished Stainless Steel (PSS)	\$398	\$796
	36" Door Pull		86192		\$435	\$870
Round	24" Door Pull	CS or BTB	86193		\$398	\$796
	36" Door Pull		86194		\$435	\$870

48" & 72" DOOR PULLS		Optional Mounting	Product Code	Finish	List Price	Back-to-Back List Price
Square	48" Door Pull	CS or BTB	86187	Flat Black (US19) Brushed Stainless Steel (SS) Satin Brass Stainless Steel - Lifetime (SSPVD4) Polished Stainless Steel (PSS)	\$472	\$944
	72" Door Pull		86188		\$545	\$1090
Round	48" Door Pull	CS or BTB	86189		\$472	\$944
	72" Door Pull		86190		\$545	\$1090

• Fits door thickness of 1 3/4" - 2 1/4". Specify if thicker.

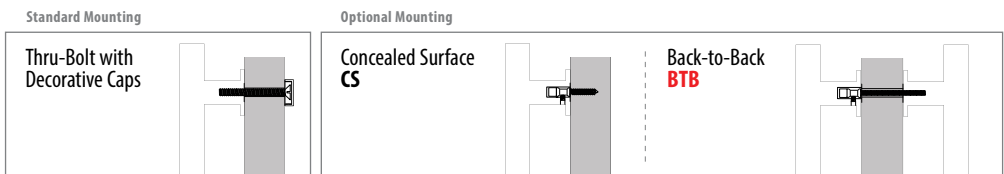

How To Order:
 CS or BTB 86187 SS + Add Door Thickness to Comments
 Concealed Surface or Back-to-Back Optional Mounting. Leave Blank for Standard Mounting. Finish Product Code

To order: (Optional Mounting) Product Code + Finish + Add Door Thickness to Comments

EUROPEAN MORTISE DEADBOLT WITH INTEGRATED ROLLER LATCH - STAINLESS STEEL



EUROPEAN MORTISE DEADBOLT WITH INTEGRATED ROLLER LATCH	Product Code	Finish	List Price
Square Keyed with Euro Profile Cylinder 2 1/4" x 2 1/4"	2050	Flat Black (US19) Brushed Stainless Steel (SS) Satin Brass Stainless Steel - Lifetime (SSPVD4) Polished Stainless Steel (PSS)	\$251
Round Keyed with Euro Profile Cylinder 2 1/4" Dia.	2051		\$251



HEAVY DUTY ROLLER LATCH	Product Code	Finish	List Price
7/8" x 6"	8803	Flat Black (US19) Brushed Stainless Steel (SS) Satin Brass Stainless Steel - Lifetime (SSPVD4) Polished Stainless Steel (PSS)	\$129

- **Handing NOT Required**
- Standard door thickness is 1 5/8" - 1 3/4". Specify if thicker.



Standard Mounting

Thru-Bolt Mount with Decorative Caps



How To Order:

86442 US19
Product Code Finish

Appliance/Door pulls are drilled and tapped for 3/8"-16 thread to accommodate thread adapters. Fits standard door thickness of 1 3/4". Specify if thicker.

Supplied with:

- Two- Thread adapters for #10-32 thread
- Two- #10-32 Flat head machine screws x 2" long
- Two- Threaded Washers
- Two- Decorative Caps

Optional Mounting

Concealed Surface Mount (CS)



How To Order:

CS 86442 US19
Concealed Surface Mount Product Code Finish

Most appliance pulls and door pulls are available with Concealed Surface mounting. Fits minimum door thickness of 1 1/4".

Supplied with:

- One grip with 3/8" diameter hole in the stem
- Two- #10, 1" bevel head wood screws
- Two- #10-32 set screws

Optional Mounting

Back-to-Back Mount (BTB)



How To Order:

BTB 86442 US19
Back-to-Back Mount Product Code Finish

Most appliance pulls and door pulls are available with Back-to-Back mounting. Fits standard door thickness of 1 3/4". Specify if thicker.

Supplied with:

- One grip with #10-32 threads in the stem
- One mating grip with 3/8" diameter hole in the stem
- Two- 3/8" diameter bevel head screws with #10-32 shaft by 2 1/2" long
- Two- #10-32 set screws

Optional Mounting

Glass Shower Door and Back-to-Back Mount (GBTB)



How To Order:

GBTB 86442 US19
Glass Shower & Back-to-Back Door Mount Product Code Finish

Most appliance pulls and door pulls are available with Glass shower door and Back-to-Back mounting. Fits glass door thickness between 1/4" - 1/2" only.

Supplied with:

- One grip with #10-32 threads in the stem
- One mating grip with 3/8" diameter hole in the stem
- Two- 3/8" diameter bevel head screws with #10-32 threads by 3/4" long
- Two- 3/8" diameter bevel head screws with #10-32 threads by 7/8" long
- Set of gaskets

CABINET APPLIANCE PULLS - SELECT



SELECT CABINET APPLIANCE PULL									Stem	Pull
Optional Mounting	Product Code	C-to-C	Overall	Width(W)	Projection(P)	Stem	List Price	Back-to-Back List Price		
CS/BTB/GBTB	84070	12"	13"	7/8"	2 1/8"	2	\$218	\$436	<p>RECTANGULAR (REC)</p> <p>TRANSITIONAL (TRA)</p>	<p>KNURLED (KN)</p> <p>SMOOTH (SM)</p>
CS/BTB/GBTB	84071	18"	19"	7/8"	2 1/8"	2	\$318	\$636		
CS/BTB/GBTB	84072	24"	25"	7/8"	2 1/8"	3	\$351	\$702		
CS/BTB/GBTB	84073	36"	37"	7/8"	2 1/8"	3	\$387	\$774		
CS/BTB/GBTB	84074	54"	55"	7/8"	2 1/8"	4	\$500	\$1000		

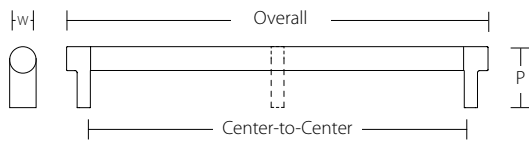

FINISH OPTIONS FOR STEM AND PULL STEM AND PULL WILL BE PERMANENTLY AFFIXED.



Satin Brass (US4)



Oil Rubbed Bronze (US10B)



Polished Nickel (US14)



Satin Nickel (US15)



Flat Black (US19)



Polished Chrome (US26)



Satin Copper (SCU)

To order: **CS/BTB/GBTB 84070 . RECUS4 . KNUS19**

Optional Mounting or Leave Blank for Standard Mounting Product Code (Center-to-Center) + Stem (Style/Finish) + Pull (Style/Finish)

Product Name:
SELECT Cabinet Appliance Pull 12" C-to-C + Rectangular Stem Satin Brass (US4) + Knurled Pull Flat Black (US19)

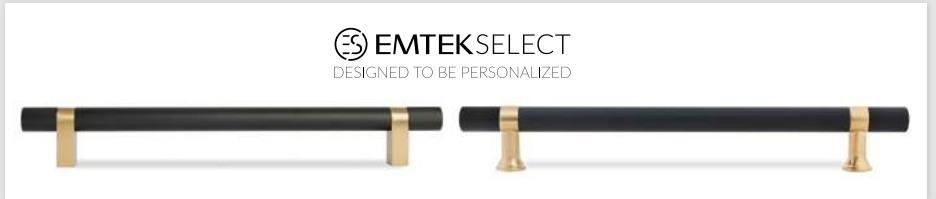

SELECT BAR CABINET APPLIANCE PULL									Stem	Pull
Optional Mounting	Product Code	C-to-C	Overall	Width(W)	Projection(P)	Stem	List Price	Back-to-Back List Price		
CS/BTB/GBTB	84170	12"	15 1/8"	7/8"	2 1/8"	2	\$230	\$460	<p>RECTANGULAR BAR (RCB)</p> <p>TRANSITIONAL BAR (TRB)</p>	<p>KNURLED (KN)</p> <p>SMOOTH (SM)</p>
CS/BTB/GBTB	84171	18"	21 1/8"	7/8"	2 1/8"	2	\$334	\$668		
CS/BTB/GBTB	84172	24"	27 1/8"	7/8"	2 1/8"	3	\$369	\$738		
CS/BTB/GBTB	84173	36"	39 1/8"	7/8"	2 1/8"	3	\$406	\$812		
CS/BTB/GBTB	84174	54"	57 1/8"	7/8"	2 1/8"	4	\$523	\$1046		

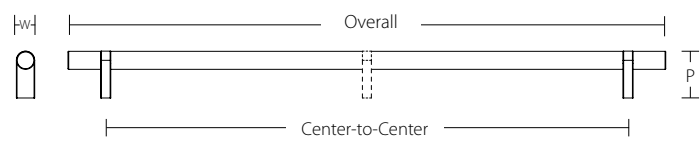

FINISH OPTIONS FOR STEM AND PULL STEM AND PULL WILL BE PERMANENTLY AFFIXED.



To order: **CS/BTB/GBTB** **84170** . **RCBUS4** . **KNUS19**

Optional Mounting or Leave Blank for Standard Mounting Product Code (Center-to-Center) + Stem (Style/Finish) + Pull (Style/Finish)

Product Name:
 SELECT Bar Cabinet Appliance Pull 12" C-to-C + Rectangular Bar Stem Satin Brass (US4) + Knurled Pull Flat Black (US19)

CABINET APPLIANCE PULLS



12" & 18" CABINET APPLIANCE PULLS		Optional Mounting*	Product Code	Finish	List Price	Back-to-Back List Price
Jasper	12" Appliance Pull	CS/BTB/GBTB	86693	Satin Brass (US4) Oil Rubbed Bronze (US10B) Polished Nickel (US14) Satin Nickel (US15) Flat Black (US19) Polished Chrome (US26)	\$218	\$436
	18" Appliance Pull	CS/BTB/GBTB	86694		\$318	\$636
Freestone	12" Appliance Pull	CS/BTB/GBTB	87001		\$218	\$436
	18" Appliance Pull	CS/BTB/GBTB	87002		\$318	\$636
Mod Hex	12" Appliance Pull	CS/BTB/GBTB	87003		\$218	\$436
	18" Appliance Pull	CS/BTB/GBTB	87004		\$318	\$636
Warwick	12" Appliance Pull	CS/BTB/GBTB	86711		\$218	\$436
	18" Appliance Pull	CS/BTB/GBTB	86712		\$318	\$636
Keaton	12" Appliance Pull	CS/BTB/GBTB	86721		\$218	\$436
	18" Appliance Pull	CS/BTB/GBTB	86722		\$318	\$636
Alexander	12" Appliance Pull	CS/BTB/GBTB	86442		\$218	\$436
	18" Appliance Pull	CS/BTB/GBTB	86443		\$318	\$636
Tribeca	12" Appliance Pull	CS/BTB/GBTB	87005		\$218	\$436
	18" Appliance Pull	CS/BTB/GBTB	87006		\$318	\$636

Standard Mounting

Optional Mounting

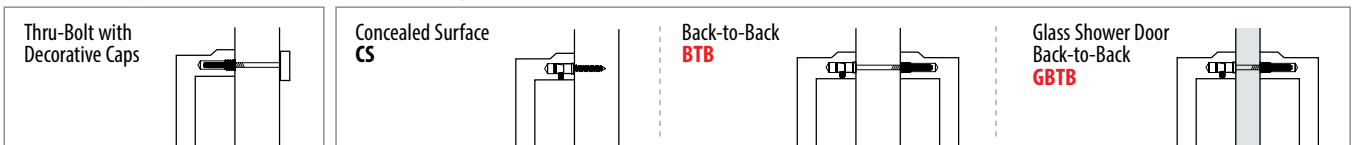



12" & 18" CABINET APPLIANCE PULLS		Optional Mounting*	Product Code	Finish	List Price	Back-to-Back List Price
Habitat	12" Appliance Pull	CS/BTB/GBTB	86628	Satin Brass (US4) Oil Rubbed Bronze (US10B) Polished Nickel (US14) Satin Nickel (US15) Flat Black (US19) Polished Chrome (US26) Satin Brass (US4) Oil Rubbed Bronze (US10B) Polished Nickel (US14) Satin Nickel (US15) Flat Black (US19) Polished Chrome (US26) Satin Brass (US4) Oil Rubbed Bronze (US10B) Polished Nickel (US14) Satin Nickel (US15) Flat Black (US19) Polished Chrome (US26) Unlacquered Brass (US3NL)*	\$218	\$436
	18" Appliance Pull	CS/BTB/GBTB	86629		\$318	\$636
Riviera	12" Appliance Pull	CS/BTB/GBTB	86621		\$218	\$436
	18" Appliance Pull	CS/BTB/GBTB	86622		\$318	\$636
Westridge	12" Appliance Pull	CS/BTB/GBTB	86640		\$218	\$436
	18" Appliance Pull	CS/BTB/GBTB	86641		\$318	\$636
Trinity	12" Appliance Pull	CS/BTB/GBTB	86444		\$218	\$436
	18" Appliance Pull	CS/BTB/GBTB	86445		\$318	\$636
Trail	12" Appliance Pull	CS/BTB/GBTB	86440		\$218	\$436
	18" Appliance Pull	CS/BTB/GBTB	86441		\$318	\$636
Bauhaus	12" Appliance Pull	CS/BTB/GBTB	86345		\$218	\$436
	18" Appliance Pull	CS/BTB/GBTB	86346		\$318	\$636
Bar	12" Appliance Pull	CS/BTB/GBTB	86351	\$218	\$436	
	18" Appliance Pull	CS/BTB/GBTB	86352	\$318	\$636	

*Unlacquered Brass (US3NL) finish available for a \$10 List Price upcharge per Door/Cabinet Appliance Pull and Back-to-Back pulls are available for a \$20 List Price upcharge per pair.

CABINET APPLIANCE PULLS



12" & 18" CABINET APPLIANCE PULLS		Optional Mounting	Product Code	Finish	List Price	Back-to-Back List Price
Blythe	12" Appliance Pull	CS/BTB/GBTB	86910	Satin Brass (US4)	\$218	\$436
	18" Appliance Pull	CS/BTB/GBTB	86911	Oil Rubbed Bronze (US10B) Polished Nickel (US14) Satin Nickel (US15)	\$318	\$636
Westwood	12" Appliance Pull	CS/BTB/GBTB	86912	Flat Black (US19) Polished Chrome (US26)	\$218	\$436
	18" Appliance Pull	CS/BTB/GBTB	86913		\$318	\$636
Spindle	12" Appliance Pull	CS/BTB/GBTB	86343	Polished Brass (US3) French Antique (US7)	\$218	\$436
	18" Appliance Pull	CS/BTB/GBTB	86344	Oil Rubbed Bronze (US10B) Polished Nickel (US14) Satin Nickel (US15) Pewter (US15A) Flat Black (US19) Polished Chrome (US26) Unlacquered Brass (US3NL)*	\$318	\$636
Rustic Modern Rectangular	12" Appliance Pull	CS/BTB/GBTB	86674	Flat Black Bronze (FB) Medium Bronze (MB)	\$239	\$478
	18" Appliance Pull	CS/BTB/GBTB	86675	Tumbled White Bronze (TWB)	\$337	\$674
Rail Sandcast Bronze	12" Appliance Pull	CS/BTB/GBTB	86349		\$239	\$478
	18" Appliance Pull	CS/BTB/GBTB	86350		\$337	\$674
Fluted Tuscany Bronze	12" Appliance Pull	CS/BTB/GBTB	86347	Flat Black Bronze (FB) Medium Bronze (MB)	\$253	\$506
	18" Appliance Pull	CS/BTB/GBTB	86348		\$354	\$708

*Unlacquered Brass (US3NL) finish available for a \$10 List Price upcharge per Door/Appliance Pull and Back-to-Back pulls are available for a \$20 List Price upcharge per pair.





BRASS & STAINLESS STEEL DOOR PULLS	Optional Mounting	Product Code	Finish	List Price	Back-to-Back List Price
Wilshire 8" Door Pull	CS/BTB/GBTB	86078	Polished Brass - Lifetime (US3) Satin Brass (US4) French Antique (US7) Oil Rubbed Bronze (US10B) Polished Nickel - Lifetime (US14) Satin Nickel (US15) Pewter (US15A) Flat Black (US19) Polished Chrome (US26) Unlacquered Brass (US3NL)*	\$155	\$310
Knoxville 8" Door Pull	CS/BTB/GBTB	86077	Polished Brass - Lifetime (US3) French Antique (US7) Oil Rubbed Bronze (US10B)	\$155	\$310
Ribbon & Reed 8" Door Pull	CS/BTB/GBTB	86080	Satin Nickel (US15) Pewter (US15A) Polished Chrome (US26) Unlacquered Brass (US3NL)*	\$155	\$310
Arts & Crafts 8" Door Pull	CS/BTB/GBTB	86079	Oil Rubbed Bronze (US10B) Satin Nickel (US15) Flat Black (US19) Unlacquered Brass (US3NL)*	\$155	\$310
Hercules Smooth 8" Door Pull	CS/BTB/GBTB	86480	Satin Brass (US4) French Antique (US7) Oil Rubbed Bronze (US10B)	\$155	\$310
Hercules Knurled 8" Door Pull	CS/BTB/GBTB	86481	Polished Nickel - Lifetime (US14) Satin Nickel (US15) Flat Black (US19)	\$155	\$310
Baden 8" Door Pull	CS/BTB/GBTB	86184	Polished Chrome (US26) Unlacquered Brass (US3NL)*	\$155	\$310
Urban Modern 8" Door Pull	CS/BTB/GBTB	86176	Satin Brass (US4) Oil Rubbed Bronze (US10B) Polished Nickel - Lifetime (US14)	\$155	\$310
Brisbane 8" Door Pull	CS/BTB/GBTB	86170	Satin Nickel (US15) Flat Black (US19) Polished Chrome (US26) Unlacquered Brass (US3NL)*	\$155	\$310
Baden Stainless Steel 8" Door Pull	CS/BTB/GBTB	S86002	Brushed Stainless Steel (SS)	\$155	\$310

*Unlacquered Brass (US3NL) finish available for a \$10 List Price upcharge per Door/Appliance Pull and Back-to-Back pulls are available for a \$20 List Price upcharge per pair.

Modern Rectangular Flush Pull
for Door Pull (Opposite Side)

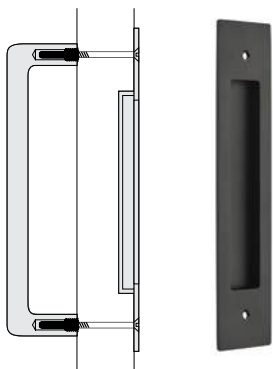

MODERN RECTANGULAR FLUSH PULLS	Product Code	Finish	List Price
2" x 10" Overall For 8" C-to-C Door Pull	221710	Polished Brass - Lifetime (US3) Satin Brass (US4) French Antique (US7) Oil Rubbed Bronze (US10B) Polished Nickel - Lifetime (US14) Satin Nickel (US15)	\$72 <i>Flush Pull Only</i>
2" x 14" Overall For 12" C-to-C Appliance Pull	221714	Pewter (US15A) Flat Black (US19) Polished Chrome (US26) Unlacquered Brass (US3NL)*	\$112 <i>Flush Pull Only</i>

- Flush pull and door pull must be ordered separately.
- Standard door thickness of 1 $\frac{3}{8}$ ". Specify if thicker.
- Supplied with matching screws.

Modern Push Plate

Modern Pull Plate
(Plate Only)
Drilled to accept 8" pull

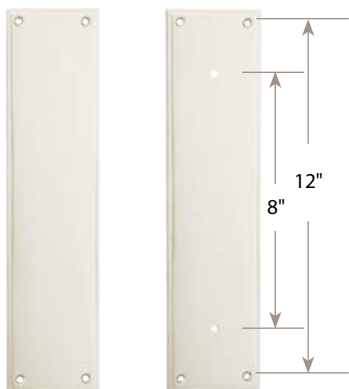

MODERN PUSH & PULL PLATES Supplied with 4 Wood Screws	Product Code	Finish	List Price
Modern Push Plate	86436	Satin Brass (US4) Oil Rubbed Bronze (US10B) Polished Nickel - Lifetime (US14)	\$112 <i>Plate Only</i>
Modern Pull Plate	86437	Satin Nickel (US15) Flat Black (US19) Polished Chrome (US26) Unlacquered Brass (US3NL)*	\$112 <i>Plate Only</i>

- Pull plate and pull must be ordered separately.
- Standard door thickness of 1 $\frac{3}{8}$ ". Specify if thicker.
- Supplied with matching screws.

Knoxville Push Plate

Knoxville Pull Plate
(Plate Only)
Drilled to accept 8" pull

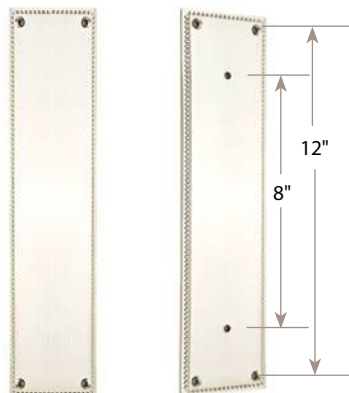

KNOXVILLE PUSH & PULL PLATES Supplied with 4 Wood Screws	Product Code	Finish	List Price
Knoxville Push Plate	86081	Polished Brass - Lifetime (US3) French Antique (US7) Oil Rubbed Bronze (US10B)	\$112 <i>Plate Only</i>
Knoxville Pull Plate	86082	Satin Nickel (US15) Pewter (US15A) Polished Chrome (US26) Unlacquered Brass (US3NL)*	\$112 <i>Plate Only</i>

- Pull plate and pull must be ordered separately.
- Standard door thickness of 1 $\frac{3}{8}$ ". Specify if thicker.
- Supplied with matching screws.

*Unlacquered Brass (US3NL) finish available for a \$10 List Price upcharge per item.

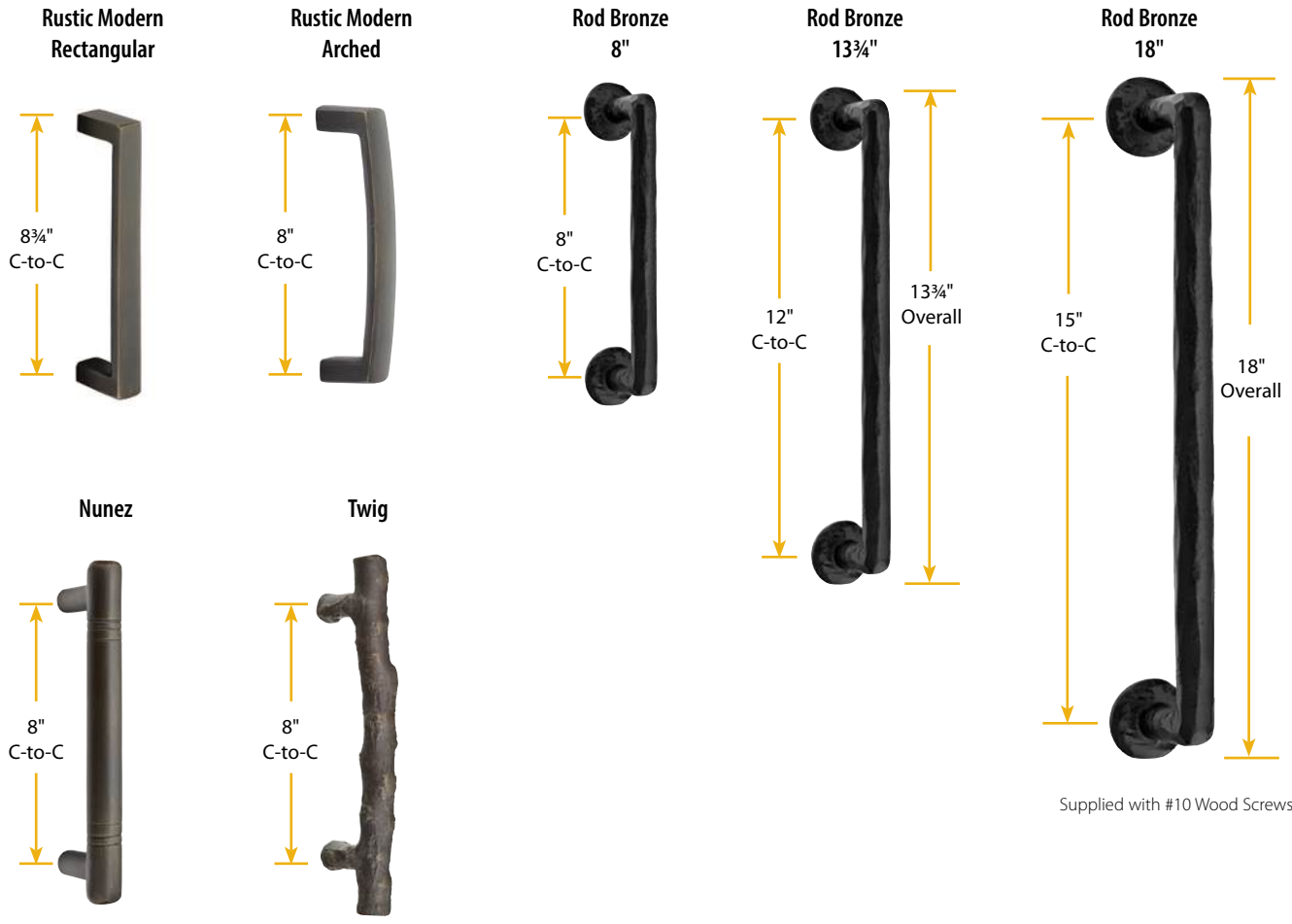

Supplied with #10 Wood Screws

SANDCAST BRONZE DOOR PULLS	Optional Mounting	Product Code	Finish	List Price	Back-to-Back List Price
Rustic Modern Rectangular Bronze 8 3/4" Pull	CS or BTB	86180	Flat Black Bronze (FB) Medium Bronze (MB) Tumbled White Bronze (TWB)	\$194	\$388
Rustic Modern Arched Bronze 8" Pull	CS or BTB	86439		\$194	\$388
Nunez Bronze 8" Pull	CS or BTB	86160		\$194	\$388
Twig Bronze 8" Pull	CS or BTB	86090		\$194	\$388
Rod Bronze 8" Pull	CS or BTB	86088		\$194	\$388
Rod Bronze 13 3/4" Pull	CS or BTB	86068		\$235	\$470
Rod Bronze 18" Pull		86089		\$369	

DOOR PULLS - TUSCANY BRONZE

Twist



Palermo

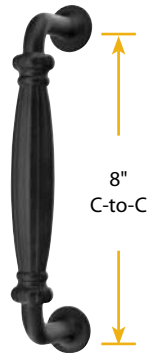

Art Nouveau
Supplied with 1 1/8 inch Threaded Tube

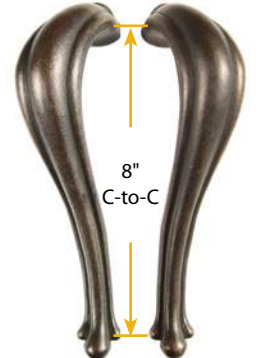

Left Hand Right Hand

Column

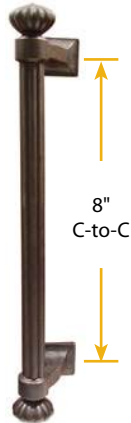

Recoleta

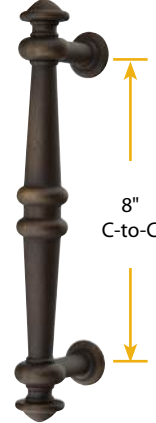

TUSCANY BRONZE DOOR PULLS	Optional Mounting	Product Code	Finish	List Price	Back-to-Back List Price
Twist 8" Pull	CS or BTB	86069	Flat Black Bronze (FB) Medium Bronze (MB)	\$194	\$388
Column 8" Pull	CS or BTB	86156		\$194	\$388
Palermo 8" Pull	CS or BTB	86167		\$194	\$388
Recoleta 8" Pull	CS or BTB	86168		\$194	\$388
Art Nouveau 8" Pull (Left Hand)		86144LH		\$194	
Art Nouveau 8" Pull (Right Hand)		86144RH		\$194	

Petal Pull Plate

Petal Push Plate
3" W x 14" H

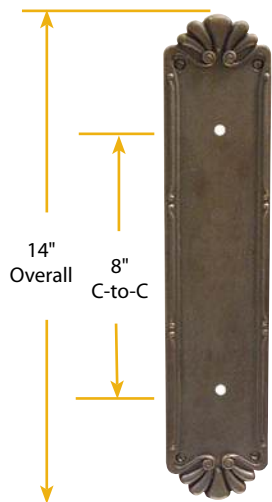

PETAL PUSH & PULL PLATES Supplied with 4 Wood Screws	Product Code	Finish	List Price
Petal Push Plate	86181	Flat Black Bronze (FB) Medium Bronze (MB)	\$188 Plate Only
Petal Pull Plate	86182		\$188 Plate Only

- Pull plate and pull must be ordered separately.
- Standard door thickness of 1 3/4". Specify if thicker.
- Supplied with matching screws.

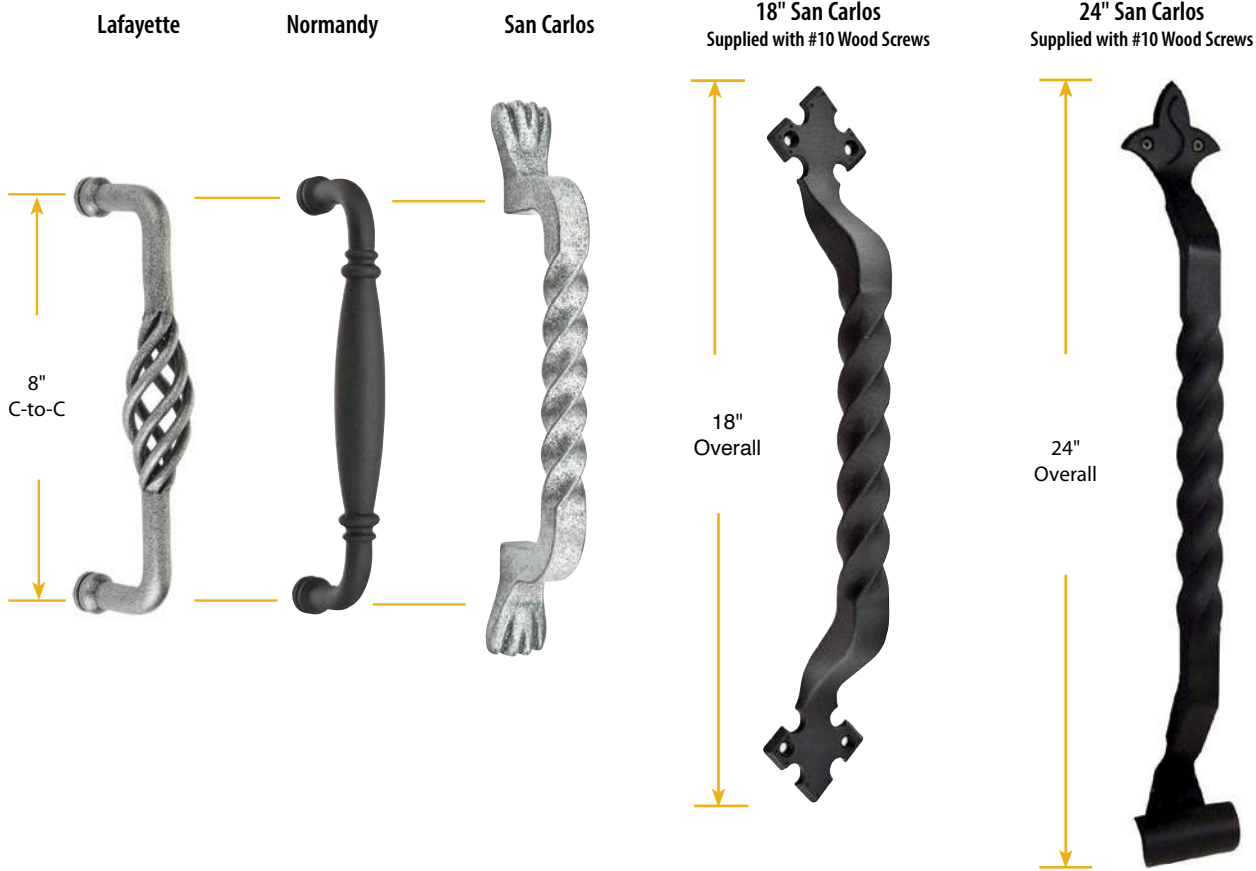

WROUGHT STEEL DOOR PULLS	Optional Mounting	Product Code	Finish	List Price	Back-to-Back List Price
	Lafayette 8" Pull	CS or BTB		76030	Flat Black Steel (FBS) Satin Steel (SWS)
Normandy 8" Pull	CS or BTB	76031	\$155	\$310	
San Carlos 8" Pull	CS or BTB	76028	\$155	\$310	
San Carlos 18" Pull		76029	\$239		
San Carlos 24" Pull		76041	\$308		

POCKET DOOR MORTISE LOCKS

Keyed



EXTERIOR

INTERIOR

- Supplied with:
- Mortise lock body includes cylinder and 2 keys
 - Strike plate and finish matching screws

Privacy



EXTERIOR

INTERIOR

- Supplied with:
- Mortise lock body
 - Strike plate and finish matching screws

Passage



EXTERIOR

INTERIOR

- Supplied with:
- Mortise lock body
 - Finish matching screws

Dummy



Strike plate accepts latch from Keyed & Privacy Mortise Locks →

EXTERIOR

INTERIOR

- Supplied with:
- Dummy mortise lock body
 - Finish matching screws

Round
2 3/4" Dia.



ROUND POCKET DOOR MORTISE LOCKS	Product Code	Finish	List Price
Passage Pocket Door Mortise Lock	2174	Satin Brass (US4)	\$308
Privacy Pocket Door Mortise Lock	2175	Oil Rubbed Bronze (US10B)	\$308
Dummy Pocket Door Mortise Lock	2176	Polished Nickel - Lifetime (US14) Satin Nickel (US15) Flat Black (US19) Polished Chrome (US26) Unlacquered Brass (US3NL)*	\$308

> Must specify door thickness for ALL functions.

*Unlacquered Brass (US3NL) finish available for a \$20 List Price upcharge per item.

Square
2 3/4" x 2 3/4"



SQUARE POCKET DOOR MORTISE LOCKS	Product Code	Finish	List Price
Passage Pocket Door Mortise Lock	2184	Satin Brass (US4)	\$308
Privacy Pocket Door Mortise Lock	2185	Oil Rubbed Bronze (US10B)	\$308
Dummy Pocket Door Mortise Lock	2186	Polished Nickel - Lifetime (US14) Satin Nickel (US15) Flat Black (US19) Polished Chrome (US26) Unlacquered Brass (US3NL)*	\$308

> Must specify door thickness for ALL functions.

*Unlacquered Brass (US3NL) finish available for a \$20 List Price upcharge per item.

#8
2 7/8" x 7 7/8"



#8 POCKET DOOR MORTISE LOCKS	Product Code	Finish	List Price
Keyed Pocket Door Mortise Lock**	2043	Polished Brass - Lifetime (US3)	\$349
Passage Pocket Door Mortise Lock	2044	Satin Brass (US4)	\$308
Privacy Pocket Door Mortise Lock	2045	French Antique (US7) Oil Rubbed Bronze (US10B)	\$308
Dummy Pocket Door Mortise Lock	2046	Polished Nickel - Lifetime (US14) Satin Nickel (US15) Pewter (US15A) Flat Black (US19) Polished Chrome (US26) Unlacquered Brass (US3NL)*	\$308

> Must specify door thickness for ALL functions.

*Unlacquered Brass (US3NL) finish available for a \$20 List Price upcharge per item.

** Emtek pocket door mortise locks can be keyed alike with each other, but may not be keyed alike with any other Emtek products.

• Handing NOT Required
• Minimum door thickness is 1 3/8".

POCKET DOOR MORTISE LOCKS

**Knurled
Narrow Modern
Rectangular
2" x 7 1/4"**



KNURLED NARROW MODERN RECTANGULAR POCKET DOOR MORTISE LOCKS	Product Code	Finish	List Price
Keyed Pocket Door Mortise Lock**	2193	Satin Brass (US4)	\$389
Passage Pocket Door Mortise Lock	2194	Oil Rubbed Bronze (US10B)	\$333
Privacy Pocket Door Mortise Lock	2195	Polished Nickel - Lifetime (US14)	\$333
Dummy Pocket Door Mortise Lock	2196	Satin Nickel (US15) Flat Black (US19) Polished Chrome (US26) Unlacquered Brass (US3NL)*	\$333

**Narrow Modern
Rectangular
2" x 7 1/4"**



NARROW MODERN RECTANGULAR POCKET DOOR MORTISE LOCKS	Product Code	List Price
Keyed Pocket Door Mortise Lock**	2153	\$349
Passage Pocket Door Mortise Lock	2154	\$308
Privacy Pocket Door Mortise Lock	2155	\$308
Dummy Pocket Door Mortise Lock	2156	\$308

**Narrow Oval
2" x 7 1/4"**



NARROW OVAL POCKET DOOR MORTISE LOCKS	Product Code	List Price
Keyed Pocket Door Mortise Lock**	2163	\$349
Passage Pocket Door Mortise Lock	2164	\$308
Privacy Pocket Door Mortise Lock	2165	\$308
Dummy Pocket Door Mortise Lock	2166	\$308

> Must specify door thickness for ALL functions.

*Unlacquered Brass (US3NL) finish available for a \$20 List Price upcharge per item.

- Handing NOT Required
- Minimum door thickness is 1 3/8".

** Emtek pocket door mortise locks can be keyed alike with each other, but may not be keyed alike with any other Emtek products.

Modern Rectangular
2 7/8" x 7 1/4"



MODERN RECTANGULAR POCKET DOOR MORTISE LOCKS	Product Code	Finish	List Price
Keyed Pocket Door Mortise Lock**	2113	Polished Brass - Lifetime (US3)	\$349
Passage Pocket Door Mortise Lock	2114	Satin Brass (US4)	\$308
Privacy Pocket Door Mortise Lock	2115	French Antique (US7)	\$308
Dummy Pocket Door Mortise Lock	2116	Oil Rubbed Bronze (US10B) Polished Nickel - Lifetime (US14) Satin Nickel (US15) Pewter (US15A) Flat Black (US19) Polished Chrome (US26) Unlacquered Brass (US3NL)*	\$308

> Must specify door thickness for ALL functions.

*Unlacquered Brass (US3NL) finish available for a \$20 List Price upcharge per item.

Classic
2 1/2" x 7 1/2"



CLASSIC POCKET DOOR MORTISE LOCKS	Product Code	Finish	List Price
Keyed Pocket Door Mortise Lock**	2103	Polished Brass (US3)	\$349
Passage Pocket Door Mortise Lock	2104	Oil Rubbed Bronze (US10B)	\$308
Privacy Pocket Door Mortise Lock	2105	Satin Nickel (US15)	\$308
Dummy Pocket Door Mortise Lock	2106	Polished Chrome (US26) Unlacquered Brass (US3NL)*	\$308

> Must specify door thickness for Keyed & Privacy functions.

*Unlacquered Brass (US3NL) finish available for a \$20 List Price upcharge per item.

Rustic Modern Rectangular
2 1/2" x 8 1/2"



SANDCAST BRONZE RUSTIC MODERN RECTANGULAR POCKET DOOR MORTISE LOCKS	Product Code	Finish	List Price
Keyed Pocket Door Mortise Lock**	2123	Flat Black Bronze (FB)	\$479
Passage Pocket Door Mortise Lock	2124	Medium Bronze (MB)	\$417
Privacy Pocket Door Mortise Lock	2125	Tumbled White Bronze (TWB)	\$417
Dummy Pocket Door Mortise Lock	2126		\$417

> Must specify door thickness for Keyed & Privacy functions.

- Handing NOT Required
- Minimum door thickness is 1 3/8".

** Emtek pocket door mortise locks can be keyed alike with each other, but may not be keyed alike with any other Emtek products.

POCKET DOOR TUBULAR LOCKS

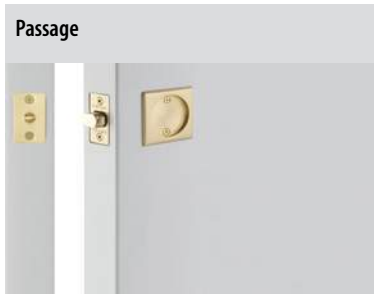

- Passage strike with raised detail to retract edge pull
- Pop-out edge pull

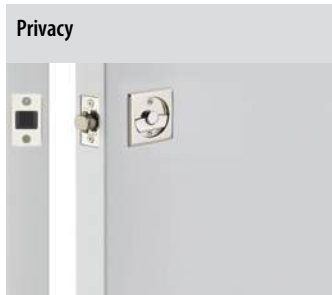

- Strike with dust box
- 2-in-1 Tubular latch with pop-out edge pull

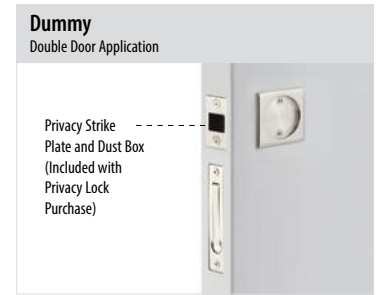

- Includes Edge Pull



Square Pocket Door Tubular Lock Passage Set, 2 1/2" x 2 1/2"



Round Pocket Door Tubular Lock Privacy Set, 2 1/2" Dia.



Rectangular Pocket Door Tubular Lock Privacy Set, 2 1/2" x 3 1/2"



#8 Pocket Door Tubular Lock Passage Set, 2 1/2" x 4 3/8"

SQUARE POCKET DOOR TUBULAR LOCKS		Product Code	Finish	List Price
Passage <i>Supplied with Passage Strike Plate</i>	2134	Polished Brass (US3) Satin Brass (US4) French Antique (US7) Oil Rubbed Bronze (US10B) Polished Nickel (US14) Satin Nickel (US15) Pewter (US15A) Flat Black (US19) Polished Chrome (US26) Unlacquered Brass (US3NL)*		\$72
Privacy <i>Supplied with Privacy Strike Plate, Dust Box</i>	2135			\$111
Dummy - Double Door Application <i>Supplied with Edge Pull</i>	2136			\$72
ROUND POCKET DOOR TUBULAR LOCKS		Product Code		List Price
Passage <i>Supplied with Passage Strike Plate</i>	2144			\$72
Privacy <i>Supplied with Privacy Strike Plate, Dust Box</i>	2145			\$111
Dummy - Double Door Application <i>Supplied with Edge Pull</i>	2146			\$72
RECTANGULAR POCKET DOOR TUBULAR LOCKS		Product Code		List Price
Passage <i>Supplied with Passage Strike Plate</i>	2014			\$72
Privacy <i>Supplied with Privacy Strike Plate, Dust Box</i>	2015			\$111
Dummy - Double Door Application <i>Supplied with Edge Pull</i>	2016			\$72
#8 POCKET DOOR TUBULAR LOCKS		Product Code		List Price
Passage <i>Supplied with Passage Strike Plate</i>	2034			\$72
Privacy <i>Supplied with Privacy Strike Plate, Dust Box</i>	2035			\$111
Dummy - Double Door Application <i>Supplied with Edge Pull</i>	2036			\$72

*Unlacquered Brass (US3NL) finish available for a \$20 List Price upcharge per item.

>> Fits door thickness 1 3/8" to 1 3/4". Standard 2 1/8" door prep. 2 3/8" backset only.



MODERN RECTANGULAR POCKET DOOR LOCKS	Product Code	Finish	List Price
Passage 2 ½" x 4 ½"	2107	Polished Brass (US3) Satin Brass (US4) French Antique (US7) Oil Rubbed Bronze (US10B) Polished Nickel (US14) Satin Nickel (US15)	\$76
Privacy 2 ½" x 4 ½"	2108	Pewter (US15A) Flat Black (US19) Polished Chrome (US26) Medium Bronze (MB) Tumbled White Bronze (TWB) Unlacquered Brass (US3NL)*	\$89



POCKET DOOR LOCKS	Product Code	Finish	List Price
Passage 2 ¾" x 3 ⅛"	2101	Polished Brass (US3) Satin Brass (US4) French Antique (US7) Oil Rubbed Bronze (US10B) Polished Nickel (US14) Satin Nickel (US15)	\$44
Privacy 2 ¾" x 3 ⅛"	2102	Pewter (US15A) Flat Black (US19) Polished Chrome (US26) Medium Bronze (MB) Tumbled White Bronze (TWB) Unlacquered Brass (US3NL)*	\$59

*Unlacquered Brass (US3NL) finish available for a \$20 List Price upcharge per item.

>> Fits door thickness 1 ¾" to 1 ¾". Supplied with finish matching screws. Screws or strikes are **NOT** sold separately.

To order: **Product Code + Finish**



BRASS KNURLED FLUSH PULL	Product Code	Finish	List Price
Modern Rectangular Knurled Flush Pull with Plain Pocket 1 3/4" x 4"	222304	Polished Brass - Lifetime (US3) Satin Brass (US4) French Antique (US7) Oil Rubbed Bronze (US10B) Polished Nickel - Lifetime (US14)	\$37
Modern Rectangular Knurled Flush Pull with Plain Pocket 2" x 7"	222307	Satin Nickel (US15) Pewter (US15A) Flat Black (US19) Polished Chrome (US26) Unlacquered Brass (US3NL)*	\$66

BRASS FLUSH PULL	Product Code	Finish	List Price
Modern Rectangular 1 3/4" x 4"	220304	Polished Brass - Lifetime (US3) Satin Brass (US4) French Antique (US7)	\$30
Modern Rectangular 1 3/4" x 6"	220306	Oil Rubbed Bronze (US10B) Polished Nickel - Lifetime (US14) Satin Nickel (US15) Pewter (US15A)	\$44
Modern Rectangular 2" x 7"	220307	Flat Black (US19) Polished Chrome (US26) Unlacquered Brass (US3NL)*	\$53
Modern Rectangular 2" x 10"	220310		\$72
Modern Rectangular 2" x 14"	220314		\$112

*Unlacquered Brass (US3NL) finish available for a \$10 List Price upcharge per item.



BRASS FLUSH PULL	Product Code	Finish	List Price
Round with Half Moon Pocket 3" Dia.	222351	Polished Brass - Lifetime (US3) Satin Brass (US4) French Antique (US7) Oil Rubbed Bronze (US10B)	\$30
Rectangular with Offset Pocket 2½" x 4"	222350	Polished Nickel - Lifetime (US14) Satin Nickel (US15) Pewter (US15A) Flat Black (US19) Polished Chrome (US26) Unlacquered Brass (US3NL)*	\$44
Square 2½" x 2½" Fits standard 2½" door prep	2213	Polished Brass - Lifetime (US3) Satin Brass (US4) French Antique (US7) Oil Rubbed Bronze (US10B)	\$25
Round 2½" Dia. Fits standard 2½" door prep	2211	Polished Nickel (US14) Satin Nickel (US15) Pewter (US15A) Flat Black (US19)	\$25
Rectangular 1¾" x 4"	2201	Polished Chrome (US26) Medium Bronze (MB) Tumbled White Bronze (TWB) Unlacquered Brass (US3NL)*	\$25
#8 1⅞" x 5"	2205		\$25
#8 1⅞" x 6"	2206		\$25

*Unlacquered Brass (US3NL) finish available for a \$10 List Price upcharge per item.

Narrow Oval



Modern Rectangular



Classic Rectangular



BRASS FLUSH PULL		Product Code	Finish	List Price
Narrow Oval with Surface Screws 2" x 7¼"	2212	Satin Brass (US4) Oil Rubbed Bronze (US10B) Polished Nickel - Lifetime (US14) Satin Nickel (US15) Flat Black (US19) Polished Chrome (US26) Unlacquered Brass (US3NL)*	\$53	
Modern Rectangular with Surface Screws 2⅞" x 7¼"	2215	Polished Brass - Lifetime (US3) Satin Brass (US4) French Antique (US7) Oil Rubbed Bronze (US10B) Polished Nickel - Lifetime (US14) Satin Nickel (US15) Pewter (US15A) Flat Black (US19) Polished Chrome (US26) Unlacquered Brass (US3NL)*	\$53	
Classic Rectangular with Surface Screws 2½" x 7½"	2216	Polished Brass (US3) Oil Rubbed Bronze (US10B) Satin Nickel (US15) Polished Chrome (US26) Unlacquered Brass (US3NL)*	\$53	

*Unlacquered Brass (US3NL) finish available for a \$10 List Price upcharge per item.

4"



6"



10"



8"



SANDCAST BRONZE FLUSH PULL		Product Code	Finish	List Price
Rustic Modern Rectangular 2" x 4"	220404	Flat Black Bronze (FB) Medium Bronze (MB) Tumbled White Bronze (TWB)	\$38	
Rustic Modern Rectangular 2" x 6"	220406		\$53	
Rustic Modern Rectangular 2 ¼" x 8"	220408		\$69	
Rustic Modern Rectangular 2 ¼" x 10"	220410		\$87	

Edge Pull



EDGE PULL	Product Code	Finish	List Price
3/4" x 4"	2221	Polished Brass (US3) Satin Brass (US4) French Antique (US7) Oil Rubbed Bronze (US10B) Polished Nickel (US14) Satin Nickel (US15) Pewter (US15A) Flat Black (US19) Polished Chrome (US26) Medium Bronze (MB) Tumbled White Bronze (TWB) Unlacquered Brass (US3NL)*	\$22

*Unlacquered Brass (US3NL) finish available for a \$10 List Price upcharge per item.

Cabinet Latch



CABINET LATCH	Product Code	Finish	List Price
2" x 2 1/4"	2270	Polished Brass (US3) Satin Brass (US4) French Antique (US7) Oil Rubbed Bronze (US10B) Polished Nickel (US14) Satin Nickel (US15) Pewter (US15A) Flat Black (US19) Polished Chrome (US26) Unlacquered Brass (US3NL)*	\$50

*Unlacquered Brass (US3NL) finish available for a \$5 List Price upcharge per item.

Window Utility Pulls



WINDOW UTILITY PULL	Product Code	Finish	List Price
4"	2244	Polished Brass (US3) French Antique (US7) Oil Rubbed Bronze (US10B)	\$15
6"	2246	Satin Nickel (US15) Pewter (US15A) Flat Black (US19) Polished Chrome (US26) Unlacquered Brass (US3NL)*	\$40

*Unlacquered Brass (US3NL) finish available for a \$10 List Price upcharge per item.

Heavy Duty Roller Latch



HEAVY DUTY ROLLER LATCH STAINLESS STEEL	Product Code	Finish	List Price
7/8" x 6"	8803	Flat Black (US19) Brushed Stainless Steel (SS) Satin Brass Stainless Steel - Lifetime (SSPVD4) Polished Stainless Steel (PSS)	\$129

Roller Catch



Ball Catch



DOOR CATCH	Product Code	Finish	List Price
Roller Catch	8801	Polished Brass (US3) Satin Brass (US4) French Antique (US7) Oil Rubbed Bronze (US10B)	\$51
Ball Catch	8802	Polished Nickel (US14) Satin Nickel (US15) Pewter (US15A) Flat Black (US19) Polished Chrome (US26) Medium Bronze (MB) Tumbled White Bronze (TWB) Unlacquered Brass (US3NL)*	\$27

*Unlacquered Brass (US3NL) finish available for a \$10 List Price upcharge per item.

Casement Latch



CASEMENT LATCH	Product Code	Finish	List Price
Standard Size 1" x 1 5/8"	8703	Polished Brass (US3) French Antique (US7) Oil Rubbed Bronze (US10B)	\$30
Large Size 1 1/16" x 2 1/16"	8713	Satin Nickel (US15) Pewter (US15A) Flat Black (US19) Polished Chrome (US26) Unlacquered Brass (US3NL)*	\$47

*Unlacquered Brass (US3NL) finish available for a \$10 List Price upcharge per item.

4" Dutch Door Bolt



DUTCH DOOR BOLT	Product Code	Finish	List Price
4"	8516	Polished Brass (US3) Satin Brass (US4) French Antique (US7) Oil Rubbed Bronze (US10B) Polished Nickel (US14) Satin Nickel (US15) Pewter (US15A) Flat Black (US19) Polished Chrome (US26) Medium Bronze (MB) Tumbled White Bronze (TWB) Unlacquered Brass (US3NL)*	\$44

>> Supplied with 2 types of strike plates with finish matching screws.



Solid Brass Surface Bolts



SOLID BRASS SURFACE BOLT	Product Code	Finish	List Price
6"	8511	Polished Brass - Lifetime (US3) Satin Brass (US4) French Antique (US7)	\$78
8"	8515	Oil Rubbed Bronze (US10B) Polished Nickel - Lifetime (US14) Satin Nickel (US15)	\$92
12"	8512	Pewter (US15A) Flat Black (US19) Polished Chrome (US26)	\$104
18"	8513	Medium Bronze (MB) Tumbled White Bronze (TWB) Unlacquered Brass (US3NL)*	\$126
24"	8514		\$151

>> Supplied with 3 types of strike plates with finish matching screws.



*Unlacquered Brass (US3NL) finish available for a \$10 List Price upcharge per item.

Keyed Patio Door Bolt



Non-Keyed Patio Door Bolt



PATIO DOOR BOLT	Product Code	Finish	List Price
Keyed	206011	Silver	\$27
	206012	Bronze	\$27
	206016	White	\$27
	206017	Black	\$27
Non-Keyed	206511	Silver	\$22
	206512	Bronze	\$22
	206516	White	\$22

Flush Bolts
Square & Radius Corners



FLUSH BOLT	Product Code	Finish	List Price
4" with Square Corners	8505	Polished Brass - Lifetime (US3) Satin Brass (US4)	\$17
4" with 5/8" Radius Corners	8506	French Antique (US7) Oil Rubbed Bronze (US10B)	\$17
6" with Square Corners	8501	Polished Nickel - Lifetime (US14) Satin Nickel (US15)	\$22
6" with 5/8" Radius Corners	8502	Pewter (US15A) Flat Black (US19)	\$22
12" with Square Corners	8503	Polished Chrome (US26) Medium Bronze (MB)	\$40
12" with 5/8" Radius Corners	8504	Tumbled White Bronze (TWB) Unlacquered Brass (US3NL)*	\$40

Modern Rectangular
Jamb Bolt



MODERN RECTANGULAR JAMB BOLT	Product Code	Finish	List Price
1 1/4" x 4 3/8"	2220	Polished Brass - Lifetime (US3) Satin Brass (US4) French Antique (US7) Oil Rubbed Bronze (US10B) Polished Nickel - Lifetime (US14) Satin Nickel (US15) Pewter (US15A) Flat Black (US19) Polished Chrome (US26) Unlacquered Brass (US3NL)*	\$27

Jamb Bolt



JAMB BOLT	Product Code	Finish	List Price
1 1/4" x 3"	2219	Polished Brass - Lifetime (US3) Satin Brass (US4) French Antique (US7) Oil Rubbed Bronze (US10B) Polished Nickel - Lifetime (US14) Satin Nickel (US15) Pewter (US15A) Flat Black (US19) Polished Chrome (US26) Medium Bronze (MB) Tumbled White Bronze (TWB) Unlacquered Brass (US3NL)*	\$13

*Unlacquered Brass (US3NL) finish available for a \$10 List Price upcharge per item.



BASEBOARD DOOR BUMPER	Product Code	Finish	List Price
4"	2237	Satin Brass (US4) French Antique (US7) Oil Rubbed Bronze (US10B) Polished Nickel - Lifetime (US14) Satin Nickel (US15) Flat Black (US19) Polished Chrome (US26) Unlacquered Brass (US3NL)*	\$25

Extendable Baseboard Door Bumper



EXTENDABLE BASEBOARD DOOR BUMPER	Product Code	Finish	List Price
3½" or 4½"	2233	Satin Brass (US4) Oil Rubbed Bronze (US10B) Polished Nickel (US14) Satin Nickel (US15) Flat Black (US19) Polished Chrome (US26) Unlacquered Brass (US3NL)*	\$27

>> Includes 3", 1", and ½" base with 2" screws.

3" Magnetic Door Stop & Holder



MAGNETIC DOOR STOP & HOLDER	Product Code	Finish	List Price
3"	2256	Polished Brass (US3) French Antique (US7) Oil Rubbed Bronze (US10B) Satin Nickel (US15) Pewter (US15A) Polished Chrome (US26) Unlacquered Brass (US3NL)*	\$40

Door Stops 3" and 4"



DOOR STOP	Product Code	Finish	List Price
3"	2232	Polished Brass (US3) Satin Brass (US4) French Antique (US7)	\$17
4"	2231	Oil Rubbed Bronze (US10B) Polished Nickel (US14) Satin Nickel (US15) Pewter (US15A) Flat Black (US19) Polished Chrome (US26) Medium Bronze (MB) Tumbled White Bronze (TWB) Unlacquered Brass (US3NL)*	\$22

Floor Door Bumper



FLOOR DOOR BUMPER	Product Code	Finish	List Price
1¾" x 1¼"	2254	Polished Brass (US3) French Antique (US7) Oil Rubbed Bronze (US10B) Satin Nickel (US15) Pewter (US15A) Polished Chrome (US26) Unlacquered Brass (US3NL)*	\$17

*Unlacquered Brass (US3NL) finish available for a \$10 List Price upcharge per item.

Square Floor Bumpers

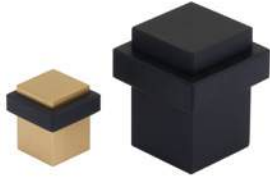

SQUARE FLOOR BUMPER	Product Code	Finish	List Price
1 3/8"	2234	Satin Brass (US4) French Antique (US7) Oil Rubbed Bronze (US10B) Polished Nickel - Lifetime (US14) Satin Nickel (US15) Flat Black (US19) Polished Chrome (US26) Unlacquered Brass (US3NL)*	\$27
2 1/2"	2235		\$30

Cylinder Floor Bumpers
1 1/2" and 2"



CYLINDER FLOOR BUMPER	Product Code	Finish	List Price
1 1/2" Cylinder	2257	Satin Brass (US4) Oil Rubbed Bronze (US10B) Polished Nickel - Lifetime (US14) Satin Nickel (US15) Flat Black (US19) Polished Chrome (US26) Unlacquered Brass (US3NL)*	\$27
2" Cylinder	2258		\$30

Cylinder Floor Bumpers
with Dome Cap
1 1/2" and 2"



CYLINDER FLOOR BUMPER WITH DOME CAP	Product Code	Finish	List Price
1 1/2" Cylinder Dome Cap	2259	Oil Rubbed Bronze (US10B) Satin Nickel (US15) Flat Black (US19) Polished Chrome (US26) Unlacquered Brass (US3NL)*	\$27
2" Cylinder Dome Cap	2260		\$30

Half Dome
Door Stop



Goose Style
Door Stop



DOOR STOP	Product Code	Finish	List Price
Half Dome	2251	Polished Brass (US3) Satin Brass (US4) French Antique (US7) Oil Rubbed Bronze (US10B) Polished Nickel (US14) Satin Nickel (US15) Pewter (US15A) Flat Black (US19) Polished Chrome (US26) Medium Bronze (MB) Tumbled White Bronze (TWB) Unlacquered Brass (US3NL)*	\$22
Goose Style	2253		\$38

*Unlacquered Brass (US3NL) finish available for a \$10 List Price upcharge per item.

Wall Bumper with #8 Rosette



Wall Bumper with Square Rosette



Wall Bumper with Regular Rosette



Wall Bumper with #2 Rosette



4" Bronze Door Knocker



Urn Style



WALL BUMPER	Product Code	Finish	List Price
Available for All Rosettes	2255	See Pages 10-26 for Available Rosette Styles and Finish options.	\$22

>> **NOT** available in Satin Rose Gold and Matte White finishes.

BRONZE DOOR KNOCKER	Product Code	Finish	List Price
4" with Ring Pull	86060	Flat Black Bronze (FB) Medium Bronze (MB) Tumbled White Bronze (TWB)	\$87

SOLID BRASS DOOR KNOCKER	Product Code	Finish	List Price
Urn	2620	Polished Brass (US3) Oil Rubbed Bronze (US10B) Satin Nickel (US15) Flat Black (US19) Unlacquered Brass (US3NL)*	\$69

>> We recommend that US3 finish be selected for those who intend to have the door knocker engraved. Emtek does not offer engraving services at this time.

***Unlacquered Brass (US3NL)** finish available for a \$10 List Price upcharge per item.

Solid Brass Mail Slot



SOLID BRASS MAIL SLOT	Product Code	Finish	List Price
3 $\frac{3}{8}$ " x 13 $\frac{1}{16}$ "	2280	Polished Brass - Lifetime (US3) Satin Brass (US4) Oil Rubbed Bronze (US10B) Satin Nickel (US15) Flat Black (US19)	\$134

>> Complete set includes both interior and exterior trims. Supplied with wood screws. Not available in split finish.

Mail Slot Sleeve



MAIL SLOT SLEEVE	Product Code	List Price
2 $\frac{7}{8}$ " x 11 $\frac{1}{16}$ "	2281	\$48

>> Stainless steel construction for durability.

Solid Brass Door Viewer



Front side

Back side

SOLID BRASS DOOR VIEWER	Product Code	Finish	List Price
$\frac{5}{8}$ " Dia. Hole Diameter	2610	Polished Brass - Lifetime (US3) Satin Brass (US4) Oil Rubbed Bronze (US10B) Satin Nickel (US15) Flat Black (US19)	\$27

>> 200 Degree Viewing Angle. Fits door thickness from 1 $\frac{3}{8}$ " to 2". Not available in split finish.

DOOR ACCESSORIES

Solid Brass
with Arch Style

Interior Exterior

Sandcast Bronze
with Arch Style

Interior Exterior

SCREEN DOOR LOCK - ARCH STYLE	Product Code	Handing	Finish	List Price
Solid Brass 1¼" x 6"	2290	LH/RH	Polished Brass - Lifetime (US3) Oil Rubbed Bronze (US10B) Satin Nickel (US15) Flat Black (US19) Unlacquered Brass (US3NL)*	\$204
Sandcast Bronze 1¼" x 6"	2290	LH/RH	Medium Bronze (MB) Tumbled White Bronze (TWB)	\$204

Solid Brass
with Rectangular Style

Interior Exterior

Sandcast Bronze
with Rectangular Style

Interior Exterior

SCREEN DOOR LOCK - RECTANGULAR STYLE	Product Code	Handing	Finish	List Price
Solid Brass 1¼" x 6"	2291	LH/RH	Polished Brass - Lifetime (US3) Oil Rubbed Bronze (US10B) Satin Nickel (US15) Flat Black (US19) Unlacquered Brass (US3NL)*	\$204
Sandcast Bronze 1¼" x 6"	2291	LH/RH	Medium Bronze (MB) Tumbled White Bronze (TWB)	\$204

*Unlacquered Brass (US3NL) finish available for a \$10 List Price upcharge per item.

- **Handing Required for Screen Door Locks.**
- Supplied with mortise lock body, strike plates and finish matching screws.
- **NOT** available knob by knob, lever by lever. **NOT** available in split finish.

SELECT Double Hook
Square Stem . Knurled Tip
Small Square Rosette



SELECT Single Hook
Square Stem . Smooth Tip
Step Square Rosette



SELECT U Hook
Square Stem . Knurled Tip
Chamfered Square Rosette



SELECT Double Hook
Round Stem . Smooth Tip
Small Disc Rosette



SELECT Single Hook
Round Stem . Knurled Tip
Step Disk Rosette



SELECT U Hook
Round Stem . Smooth Tip
Soft Square Rosette



SELECT HOOK - DOUBLE					Stem	Tip	Rosette	
	Product Code	Projection(P)	Overall	List Price	Square (SQ) Round (RD)	Knurled (KN) Smooth (SM)	Small Disc (00) Step Disk (TD)	Small Square (MQ) Chamfered Square (CQ)
	2266	2 7/8"	3 5/8"	\$77				
SELECT HOOK - SINGLE								
	Product Code	Projection(P)	Width(W)	List Price	Square (SQ) Round (RD)	Knurled (KN) Smooth (SM)	Small Square (MQ) Chamfered Square (CQ)	Soft Square (FQ) Step Square (TQ)
	2267	3"	5/8"	\$63				
SELECT HOOK - U HOOK								
	Product Code	Projection(P)	Width(W)	List Price	Square (SQ) Round (RD)	Knurled (KN) Smooth (SM)	Soft Square (FQ) Step Square (TQ)	
	2268	3 1/2"	5/8"	\$77				

FINISH OPTIONS								STEM AND TIP WILL BE PERMANENTLY AFFIXED.	
Satin Brass (US4)	French Antique (US7)	Oil Rubbed Bronze (US10B)	Polished Nickel (US14) - Lifetime	Satin Nickel (US15)	Flat Black (US19)	Polished Chrome (US26)	Unlacquered Brass (US3NL)*		
To order: 2266 . TDUS26 . SQUS4 . SMUS26								Product Name: SELECT Double Hook Round + Step Disk Rosette (US26) + Square Stem (US4) + Smooth Tip (US26)	
Product Code	+	Rosette (Style/Finish)	+	Stem (Style/Finish)	+	Tip (Style/Finish)			

*Unlacquered Brass (US3NL) finish available for a \$10 List Price upcharge per item.

>> SELECT Hooks Bath Hardware may also be ordered with any Brass rosette at the list price shown above.

Modern Tubular Brass Single Robe Hook with Rosette



Modern Tubular Brass Single Hook with Rosette



Modern Brass Double Hook with Rosette



Transitional Flared Brass Single Hook with Rosette



Transitional Brass Single Hook with Rosette



MODERN BRASS HOOK WITH ROSETTE			
	Product Code	Finish	List Price
Modern Tubular Brass Single Robe Hook with Rosette	2285	Satin Brass (US4) French Antique (US7) Oil Rubbed Bronze (US10B) Polished Nickel - Lifetime (US14) Satin Nickel (US15) Flat Black (US19) Polished Chrome (US26) Unlacquered Brass (US3NL)*	\$53
Modern Tubular Brass Single Hook with Rosette	2286	Satin Brass (US4) French Antique (US7) Oil Rubbed Bronze (US10B) Polished Nickel - Lifetime (US14) Satin Nickel (US15) Flat Black (US19) Polished Chrome (US26) Unlacquered Brass (US3NL)*	\$65
Modern Brass Double Hook with Rosette	2809	Satin Brass (US4) Oil Rubbed Bronze (US10B) Polished Nickel - Lifetime (US14) Satin Nickel (US15) Flat Black (US19) Polished Chrome (US26) Unlacquered Brass (US3NL)*	\$65
TRANSITIONAL BRASS HOOK WITH ROSETTE			
	Product Code	Finish	List Price
Transitional Flared Brass Single Hook with Rosette	2295	Satin Brass (US4) French Antique (US7) Oil Rubbed Bronze (US10B) Polished Nickel - Lifetime (US14) Satin Nickel (US15) Flat Black (US19) Polished Chrome (US26) Unlacquered Brass (US3NL)*	\$62
Transitional Brass Single Hook with Rosette	2909	Satin Brass (US4) Oil Rubbed Bronze (US10B) Polished Nickel - Lifetime (US14) Satin Nickel (US15) Flat Black (US19) Polished Chrome (US26) Unlacquered Brass (US3NL)*	\$53

*Unlacquered Brass (US3NL) finish available for a \$10 List Price upcharge per item.

>> See pages 10-23 for Brass Rosette Options. Page 211 for Small Rosette Options.

Traditional Brass Double Hook with Rosette



TRADITIONAL BRASS HOOK WITH ROSETTE	Product Code	Finish	List Price
Traditional Brass Double Hook with Rosette	2609	Polished Brass - Lifetime (US3) French Antique (US7) Oil Rubbed Bronze (US10B) Polished Nickel - Lifetime (US14) Satin Nickel (US15)	\$47
Traditional Brass Single Hook with Rosette	2608	Pewter (US15A) Flat Black (US19) Polished Chrome (US26) Unlacquered Brass (US3NL)*	

Traditional Brass Single Hook with Rosette



>> See pages 10-23 for Brass Rosette Options. Page 211 for Small Rosette Options.

Solid Brass Double Hook

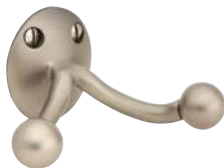

SOLID BRASS DOUBLE HOOK	Product Code	Finish	List Price
Base Height: 1¾" Projection: 2⅞"	2607	Polished Brass - Lifetime (US3) French Antique (US7) Oil Rubbed Bronze (US10B) Polished Nickel - Lifetime (US14) Satin Nickel (US15) Pewter (US15A) Flat Black (US19) Polished Chrome (US26) Unlacquered Brass (US3NL)*	\$27

Solid Brass Robe Hook



SOLID BRASS ROBE HOOK	Product Code	Finish	List Price
Base Height: 1¾" Projection: 2⅞"	2606	Polished Brass - Lifetime (US3) Satin Brass (US4) French Antique (US7) Oil Rubbed Bronze (US10B) Polished Nickel - Lifetime (US14) Satin Nickel (US15) Pewter (US15A) Flat Black (US19) Polished Chrome (US26) Unlacquered Brass (US3NL)*	\$27

*Unlacquered Brass (US3NL) finish available for a \$10 List Price upcharge per item.

Sandcast Bronze 3 Hooks with Rectangular Plate



SANDCAST BRONZE 3 HOOKS WITH RECTANGULAR PLATE	Product Code	Finish	List Price
9½" x 2" Projection: 2½"	2307	Flat Black (FB) Medium Bronze (MB) Tumbled White Bronze (TWB)	\$106

Sandcast Bronze Double Hook



SANDCAST BRONZE DOUBLE HOOK	Product Code	Finish	List Price
Base Height: 1¾" Projection: 2½"	2306	Flat Black (FB) Medium Bronze (MB) Tumbled White Bronze (TWB)	\$36

Sandcast Bronze Robe Hook



SANDCAST BRONZE ROBE HOOK	Product Code	Finish	List Price
Base Height: 1½" Projection: 2½"	86106	Flat Black (FB) Medium Bronze (MB) Tumbled White Bronze (TWB)	\$36

Sandcast Bronze Single Hook



SANDCAST BRONZE SINGLE HOOK	Product Code	Finish	List Price
See Pages 24-25 for Sandcast Bronze Rosette Options.	2308	Flat Black Bronze (FB) Medium Bronze (MB) Tumbled White Bronze (TWB)	\$47

Tuscany Bronze Double Hook



TUSCANY BRONZE DOUBLE HOOK	Product Code	Finish	List Price
Base Height: 1¾" Projection: 2¼"	2707	Flat Black Bronze (FB) Medium Bronze (MB)	\$51

Tuscany Bronze Single Hook



TUSCANY BRONZE SINGLE HOOK	Product Code	Finish	List Price
See Pages 24-25 for Tuscany Bronze Rosette Options.	2706	Flat Black Bronze (FB) Medium Bronze (MB)	\$47

Wrought Steel Robe Hook



WROUGHT STEEL ROBE HOOK	Product Code	Finish	List Price
Base Height: 1½" Projection: 3"	25050	Flat Black Steel (FBS) Satin Steel (SWS)	\$15

Stainless Steel Single Hook



STAINLESS STEEL SINGLE HOOK	Product Code	Finish	List Price
Projection: 2¾"	S71001	Brushed Stainless Steel (SS)	\$51



<p>Mounting Options</p> <p>Finish matched standoffs included</p> <p>Floating Flush</p>	<p>Hardware Included</p> <p>Threaded Rod Optional Standoffs Anchor</p> <p>House Number Wall</p> <p>Optional Standoffs Breakaway Screws</p> <p>House Number Wood</p> <p>Surface Thru-Bolt</p>	<p>Finishes</p> <p>Satin Brass US4 Satin Nickel US15 Flat Black US19 Oil Rubbed Bronze US10B</p>
--	---	--

7" MODERN HOUSE NUMBER	Product Code	Finish	List Price
House Number Digit '0'	2830	Satin Brass (US4) Oil Rubbed Bronze (US10B) Satin Nickel (US15) Flat Black (US19)	\$40
House Number Digit '1'	2831		
House Number Digit '2'	2832		
House Number Digit '3'	2833		
House Number Digit '4'	2834		
House Number Digit '5'	2835		
House Number Digit '6'	2836		
House Number Digit '7'	2837		
House Number Digit '8'	2838		
House Number Digit '9'	2839		

>> Supplied with finish matching screws. Screws are **NOT** sold separately.



BRASS DOOR BELL WITH PLATE & BUTTON		Product Code	Finish	List Price
Door Bell Button with Regular Rosette	2400	Polished Brass - Lifetime (US3) Satin Brass (US4) French Antique (US7)	\$53	
Door Bell Button with Oval Rosette	2402	Oil Rubbed Bronze (US10B) Polished Nickel - Lifetime (US14) Satin Nickel (US15)		
Door Bell Button with Rectangular Rosette	2403	Pewter (US15A) Flat Black (US19) Polished Chrome (US26)		
Door Bell Button with #8 Rosette	2408	Unlacquered Brass (US3NL)*		
Door Bell Button with Quincy Rosette	2409			
Door Bell Button with Watford Rosette	2466			
Door Bell Button with Wilshire Rosette	2404			
Door Bell Button with Rope Rosette	2401	Polished Brass - Lifetime (US3) French Antique (US7) Oil Rubbed Bronze (US10B)		
Door Bell Button with Lancaster Rosette	2406	Satin Nickel (US15) Pewter (US15A) Polished Chrome (US26)		
Door Bell Button with Ribbon & Reed Rosette	2407	Unlacquered Brass (US3NL)*		
Door Bell Button with Arts & Crafts Rosette	2451	Oil Rubbed Bronze (US10B) Satin Nickel (US15) Flat Black (US19)	\$53	
Door Bell Button with Hammered Rosette	2452	Unlacquered Brass (US3NL)*		
Door Bell Button with Modern Rosette	2457	Satin Brass (US4) French Antique (US7) Oil Rubbed Bronze (US10B)	\$53	
Door Bell Button with Disk Rosette	2458	Polished Nickel - Lifetime (US14) Satin Nickel (US15) Flat Black (US19)		
Door Bell Button with Square Rosette	2459	Polished Chrome (US26) Unlacquered Brass (US3NL)*	\$53	
Door Bell Button with Neos Rosette	2460			
Door Bell Button with Modern Rectangular Rosette	2463		\$53	
Door Bell Button with Urban Modern Rosette	2465			

*Unlacquered Brass (US3NL) finish available for a \$10 List Price upcharge per item.

**STRETTO Oval
Solid Brass
1½" x 3"**



**STRETTO Solid Brass
1½" x 5"**



**STRETTO Solid Brass
1½" x 11"**



STRETTO BRASS DOOR BELL WITH PLATE & BUTTON	Product Code	Finish	List Price
Door Bell Button with 1½" x 3" Rosette STRETTO Oval Plate	2442	Satin Brass (US4) Oil Rubbed Bronze (US10B) Polished Nickel - Lifetime (US14) Satin Nickel (US15) Flat Black (US19) Polished Chrome (US26) Unlacquered Brass (US3NL)*	\$53
Door Bell Button with 1½" x 5" Rosette STRETTO Plate	2440		\$53
Door Bell Button with 1½" x 11" Rosette STRETTO Plate	2441		\$53

*Unlacquered Brass (US3NL) finish available for a \$10 List Price upcharge per item.



SANDCAST BRONZE DOOR BELL WITH PLATE & BUTTON	Product Code	Finish	List Price
Door Bell Button with #1 Rosette	2421	Flat Black Bronze (FB) Medium Bronze (MB) Tumbled White Bronze (TWB)	\$59
Door Bell Button with #2 Rosette	2422		\$59
Door Bell Button with #3 Rosette	2423		\$59
Door Bell Button with #4 Rosette	2424		\$59
Door Bell Button with #6 Rosette	2425		\$59



TUSCANY BRONZE DOOR BELL WITH PLATE & BUTTON	Product Code	Finish	List Price
Door Bell Button with #11 Rosette	2411	Flat Black Bronze (FB) Medium Bronze (MB)	\$59
Door Bell Button with #12 Rosette	2412		\$59
Door Bell Button with #14 Rosette	2414		\$59
Door Bell Button with #15 Rosette	2415		\$59

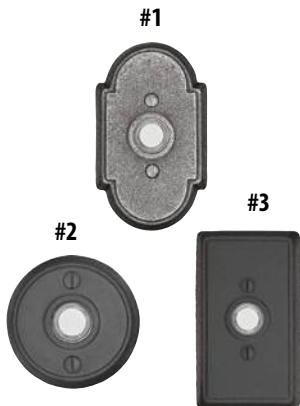

WROUGHT STEEL DOOR BELL WITH PLATE & BUTTON	Product Code	Finish	List Price
Door Bell Button with #1 Rosette	2431	Flat Black Steel (FBS) Satin Steel (SWS)	\$53
Door Bell Button with #2 Rosette	2432		\$53
Door Bell Button with #3 Rosette	2433		\$53

3 1/2" x 3 1/2"
Square Barrel



4 1/2" x 4 1/2"
Square Barrel



4" x 4"
Square Barrel

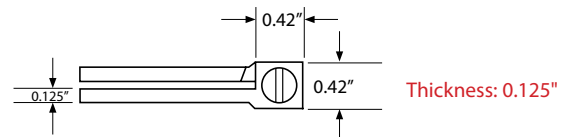

SQUARE BARREL HEAVY DUTY HINGES - SOLID BRASS Thickness: 0.125"		Product Code	Finish	List Price (Per Pair) Broken Case	List Price (Per Pair) 1 or More Cases	Hinges Per Case
3 1/2" x 3 1/2"	96313	Polished Brass - Lifetime (US3) Satin Brass (US4)	\$87	\$83	24 (Pair)	
4" x 4"	96314	French Antique (US7) Oil Rubbed Bronze (US10B) Polished Nickel (US14)	\$98	\$92	24 (Pair)	
4 1/2" x 4 1/2"	96315	Satin Nickel (US15) Pewter (US15A) Flat Black (US19) Polished Chrome (US26) Unlacquered Brass (US3NL)*	\$110	\$104	24 (Pair)	

*Unlacquered Brass (US3NL) finish available for a \$20 List Price upcharge per pair.

>> Decorative Tips are NOT available for Square Barrel Heavy Duty Hinges. See page 233 for Replacement Hinge Screw Pack Options.

SOLID BRASS HINGES - RESIDENTIAL DUTY, PLAIN BEARING

4" x 4" Residential Duty
1/4" Radius Corners



3 1/2" x 3 1/2" Residential Duty
1/4" Radius Corners



3 1/2" x 3 1/2" Residential Duty
5/8" Radius Corners



RESIDENTIAL DUTY HINGES - SOLID BRASS Plain Bearing, Thickness: 0.096" - 0.098"		Product Code	Finish	List Price (Per Pair) Broken Case	List Price (Per Pair) 1 or More Cases	Hinges Per Case
3 1/2" x 3 1/2" with Square Corners	96113	Polished Brass - Lifetime (US3) Satin Brass (US4) French Antique (US7)	\$53	\$47	24 (Pair)	
4" x 4" with Square Corners	96114	Oil Rubbed Bronze (US10B) Polished Nickel (US14) Satin Nickel (US15)	\$63	\$53	24 (Pair)	
3 1/2" x 3 1/2" with 1/4" Radius Corners	96123	Pewter (US15A) Flat Black (US19) Polished Chrome (US26)	\$53	\$47	24 (Pair)	
4" x 4" with 1/4" Radius Corners	96124	Unlacquered Brass (US3NL)*	\$63	\$53	24 (Pair)	
3 1/2" x 3 1/2" with 5/8" Radius Corners	96133		\$53	\$47	24 (Pair)	
4" x 4" with 5/8" Radius Corners	96134		\$63	\$53	24 (Pair)	

*Unlacquered Brass (US3NL) finish available for a \$20 List Price upcharge per pair.

>> See pages 223-225 for Decorative Tip Sets for Solid Brass Hinges and page 233 for Replacement Hinge Screw Pack Options.

4 1/2" x 4 1/2" Heavy Duty
Square Corners



3 1/2" x 3 1/2" Heavy Duty
1/4" Radius Corners



4" x 4" Heavy Duty
5/8" Radius Corners



HEAVY DUTY HINGES - SOLID BRASS Plain Bearing, Thickness: 0.130" - 0.132"		Product Code	Finish	List Price (Per Pair) Broken Case	List Price (Per Pair) 1 or More Cases	Hinges Per Case
3 1/2" x 3 1/2" with Square Corners	96213	Polished Brass - Lifetime (US3) Satin Brass (US4) French Antique (US7)	Unlacquered Brass (US3NL)* Oil Rubbed Bronze (US10B) Polished Nickel (US14) Satin Nickel (US15) Pewter (US15A) Flat Black (US19) Polished Chrome (US26)	\$65	\$59	24 (Pair)
4" x 4" with Square Corners	96214			\$74	\$69	24 (Pair)
4 1/2" x 4 1/2" with Square Corners	96215			\$85	\$78	24 (Pair)
3 1/2" x 3 1/2" with 1/4" Radius Corners	96223			\$65	\$59	24 (Pair)
4" x 4" with 1/4" Radius Corners	96224			\$74	\$69	24 (Pair)
4 1/2" x 4 1/2" with 1/4" Radius Corners	96225			\$85	\$78	24 (Pair)
3 1/2" x 3 1/2" with 5/8" Radius Corners	96233			\$65	\$59	24 (Pair)
4" x 4" with 5/8" Radius Corners	96234			\$74	\$69	24 (Pair)

*Unlacquered Brass (US3NL) finish available for a \$20 List Price upcharge per pair.

>> See pages 223-225 for Decorative Tip Sets for Solid Brass Hinges and page 233 for Replacement Hinge Screw Pack Options.

SOLID BRASS HINGES - HEAVY DUTY, BALL BEARING

3 ½" x 3 ½" Heavy Duty
Square Corners



4 ½" x 4 ½" Heavy Duty
¼" Radius Corners



HEAVY DUTY HINGES - SOLID BRASS Ball Bearing, Thickness: 0.122" - 0.134"		Product Code	Finish	List Price (Per Pair) Broken Case	List Price (Per Pair) 1 or More Cases	Hinges Per Case
3 ½" x 3 ½" with Square Corners	96413	Polished Brass - Lifetime (US3) Satin Brass (US4) French Antique (US7)	Unlacquered Brass (US3NL)*	\$74	\$69	24 (Pair)
4" x 4" with Square Corners	96414	Oil Rubbed Bronze (US10B) Polished Nickel (US14) Satin Nickel (US15)		\$85	\$78	24 (Pair)
4 ½" x 4 ½" with Square Corners	96415	Pewter (US15A) Flat Black (US19) Polished Chrome (US26)		\$96	\$87	24 (Pair)
5" x 5" with Square Corners	96416			\$106	\$98	24 (Pair)
4 ½" x 4 ½" with ¼" Radius Corners	96425			\$96	\$87	24 (Pair)

*Unlacquered Brass (US3NL) finish available for a \$20 List Price upcharge per pair.

>> See pages 223-225 for Decorative Tip Sets for Solid Brass Hinges and page 233 for Replacement Hinge Screw Pack Options.

Knurled Tip



Faceted Tip



Straight Knurled Tip



KNURLED TIP SETS 4 tips per set		Product Code	Finish	List Price
for 3 1/2" x 3 1/2" Residential Duty Hinges	97253	Polished Brass - Lifetime (US3) Satin Brass (US4) French Antique (US7) Oil Rubbed Bronze (US10B) Polished Nickel (US14) Satin Nickel (US15) Pewter (US15A) Flat Black (US19) Polished Chrome (US26) Unlacquered Brass (US3NL)*		\$30
for 4" x 4" Residential Duty Hinges	97254			\$30
for 3 1/2" x 3 1/2" Heavy Duty Plain or Ball Bearing Hinges	97255			\$30
for 4" x 4" Heavy Duty Plain or Ball Bearing Hinges	97256			\$30
for 4 1/2" x 4 1/2" or 5" x 5" Heavy Duty Plain or Ball Bearing Hinges	97257			\$30
FACETED TIP SETS 4 tips per set		Product Code		List Price
for 3 1/2" x 3 1/2" Residential Duty Hinges	97263			\$30
for 4" x 4" Residential Duty Hinges	97264			\$30
for 3 1/2" x 3 1/2" Heavy Duty Plain or Ball Bearing Hinges	97265			\$30
for 4" x 4" Heavy Duty Plain or Ball Bearing Hinges	97266			\$30
for 4 1/2" x 4 1/2" or 5" x 5" Heavy Duty Plain or Ball Bearing Hinges	97267			\$30
STRAIGHT KNURLED TIP SETS 4 tips per set		Product Code		List Price
for 3 1/2" x 3 1/2" Residential Duty Hinges	97273			\$30
for 4" x 4" Residential Duty Hinges	97274			\$30
for 3 1/2" x 3 1/2" Heavy Duty Plain or Ball Bearing Hinges	97275			\$30
for 4" x 4" Heavy Duty Plain or Ball Bearing Hinges	97276			\$30
for 4 1/2" x 4 1/2" or 5" x 5" Heavy Duty Plain or Ball Bearing Hinges	97277			\$30

*Unlacquered Brass (US3NL) finish available for a \$10 List Price upcharge per set.

Tip sets are available in 1/2 pair (2 tips) for 50% of the list price. Please use quantity (.5) When ordering.

DECORATIVE HINGE TIPS FOR SOLID BRASS HINGES

Ball Tip
for 3 ½" Hinges



Ball Tip
for 4 ½" Hinges



BALL TIP SETS 4 tips per set	Product Code	Finish	List Price
for 3 ½" x 3 ½" Residential Duty Hinges	97203	Polished Brass - Lifetime (US3) Satin Brass (US4) French Antique (US7) Oil Rubbed Bronze (US10B)	\$25
for 4" x 4" Residential Duty Hinges	97204	Polished Nickel (US14) Satin Nickel (US15) Pewter (US15A) Flat Black (US19) Polished Chrome (US26)	\$25
for 3 ½" x 3 ½" Heavy Duty Plain or Ball Bearing Hinges	97303	Unlacquered Brass (US3NL)*	\$25
for 4" x 4" Heavy Duty Plain or Ball Bearing Hinges	97304		\$25
for 4 ½" x 4 ½" or 5" x 5" Heavy Duty Plain or Ball Bearing Hinges	97305		\$25

*Unlacquered Brass (US3NL) finish available for a **\$10 List Price** upcharge per set.

Steeple Tip
for 3 ½" Hinges



Steeple Tip
for 4" Hinges



STEEPLE TIP SETS 4 tips per set	Product Code	Finish	List Price
for 3 ½" x 3 ½" Residential Duty Hinges	97213	Polished Brass - Lifetime (US3) Satin Brass (US4) French Antique (US7) Oil Rubbed Bronze (US10B)	\$25
for 4" x 4" Residential Duty Hinges	97214	Polished Nickel (US14) Satin Nickel (US15) Pewter (US15A) Flat Black (US19) Polished Chrome (US26)	\$25
for 3 ½" x 3 ½" Heavy Duty Plain or Ball Bearing Hinges	97313	Unlacquered Brass (US3NL)*	\$25
for 4" x 4" Heavy Duty Plain or Ball Bearing Hinges	97314		\$25
for 4 ½" x 4 ½" or 5" x 5" Heavy Duty Plain or Ball Bearing Hinges	97315		\$25

*Unlacquered Brass (US3NL) finish available for a **\$10 List Price** upcharge per set.

Button Tip
for 3 1/2" Hinges



Button Tip
for 4" Hinges



BUTTON TIP SETS 4 tips per set		Product Code	Finish	List Price
for 3 1/2" x 3 1/2" Residential Duty Hinges	97223	Polished Brass - Lifetime (US3) Satin Brass (US4) French Antique (US7) Oil Rubbed Bronze (US10B)	\$25	
for 4" x 4" Residential Duty Hinges	97224	Polished Nickel (US14) Satin Nickel (US15) Pewter (US15A) Flat Black (US19)		
for 3 1/2" x 3 1/2" Heavy Duty Plain or Ball Bearing Hinges	97323	Polished Chrome (US26) Unlacquered Brass (US3NL)*		
for 4" x 4" Heavy Duty Plain or Ball Bearing Hinges	97324			
for 4 1/2" x 4 1/2" or 5" x 5" Heavy Duty Plain or Ball Bearing Hinges	97325			

*Unlacquered Brass (US3NL) finish available for a \$10 List Price upcharge per set.

Extended
Button Tip



EXTENDED BUTTON TIP		Product Code	Finish	List Price
Used with Hinge Pivot Stop on Solid Brass Hinge.	2242	Polished Brass (US3) Satin Brass (US4) French Antique (US7) Oil Rubbed Bronze (US10B) Polished Nickel (US14) Satin Nickel (US15) Pewter (US15A) Flat Black (US19) Polished Chrome (US26) Unlacquered Brass (US3NL)*	\$6 ea	

*Unlacquered Brass (US3NL) finish available for a \$10 List Price upcharge per item.

Hinges
Pivot Stop



HINGES PIVOT STOP		
Product Code	Finish	List Price
2241	Polished Brass (US3) Satin Brass (US4) French Antique (US7) Oil Rubbed Bronze (US10B) Polished Nickel (US14) Satin Nickel (US15) Pewter (US15A) Flat Black (US19) Polished Chrome (US26) Medium Bronze (MB) Tumbled White Bronze (TWB) Unlacquered Brass (US3NL)*	\$14

*Unlacquered Brass (US3NL) finish available for a \$10 List Price upcharge per item.

Hinge Pivot with
Solid Brass Hinge

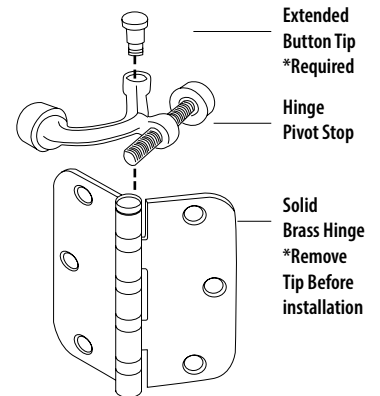

>> Requires Extended Button Tip when used with Solid Brass Hinges. **Not compatible with ANY Steel Hinges.**

STEEL HINGES - RESIDENTIAL DUTY, PLAIN BEARING

4" x 4" Residential Duty
Square Corners



3 1/2" x 3 1/2" Residential Duty
1/4" Radius Corners



4" x 4" Residential Duty
5/8" Radius Corners



RESIDENTIAL DUTY HINGES - STEEL Plain Bearing, Thickness: 0.084" - 0.090"		Product Code	Finish	List Price (Per Pair) Broken Case	List Price (Per Pair) 1 or More Cases	Hinges Per Case
3 1/2" x 3 1/2" with Square Corners*	91013	Polished Brass (US3) Satin Brass (US4) French Antique (US7) Oil Rubbed Bronze (US10B) Polished Nickel (US14) Satin Nickel (US15) Pewter (US15A) Flat Black (US19) Polished Chrome (US26) Medium Bronze (MB) Tumbled White Bronze (TWB)		\$16	\$15	24 (Pair)
4" x 4" with Square Corners**	91014			\$19	\$16	24 (Pair)
3 1/2" x 3 1/2" with 1/4" Radius Corners*	91023			\$16	\$15	24 (Pair)
4" x 4" with 1/4" Radius Corners**	91024			\$19	\$16	24 (Pair)
3 1/2" x 3 1/2" with 5/8" Radius Corners*	91033			\$16	\$15	24 (Pair)
4" x 4" with 5/8" Radius Corners**	91034			\$19	\$16	24 (Pair)

* 3 1/2" x 3 1/2" Hinges have 6 screw holes per hinge in an "Arc" pattern. ** 4" x 4" Hinges have 8 screw holes per hinge in a "Zig-Zag" pattern.

>> See page 233 for Replacement Hinge Screw Pack Options.

4 1/2" x 4 1/2" Heavy Duty
Square Corners



4" x 4" Heavy Duty
1/4" Radius Corners



3 1/2" x 3 1/2" Heavy Duty
5/8" Radius Corners



HEAVY DUTY HINGES - STEEL Plain Bearing, Thickness: 0.122" - 0.134"		Product Code	Finish	List Price (Per Pair) Broken Case	List Price (Per Pair) 1 or More Cases	Hinges Per Case
3 1/2" x 3 1/2" with Square Corners	92013	Polished Brass (US3) Satin Brass (US4) French Antique (US7) Oil Rubbed Bronze (US10B) Polished Nickel (US14) Satin Nickel (US15) Pewter (US15A) Flat Black (US19) Polished Chrome (US26) Medium Bronze (MB) Tumbled White Bronze (TWB)		\$25	\$22	24 (Pair)
4" x 4" with Square Corners	92014			\$27	\$25	24 (Pair)
4 1/2" x 4 1/2" with Square Corners	92015			\$30	\$27	24 (Pair)
3 1/2" x 3 1/2" with 1/4" Radius Corners	92023			\$25	\$22	24 (Pair)
4" x 4" with 1/4" Radius Corners	92024			\$27	\$25	24 (Pair)
4 1/2" x 4 1/2" with 1/4" Radius Corners	92025			\$30	\$27	24 (Pair)
3 1/2" x 3 1/2" with 5/8" Radius Corners	92033			\$25	\$22	24 (Pair)
4" x 4" with 5/8" Radius Corners	92034			\$27	\$25	24 (Pair)

>> See page 233 for Replacement Hinge Screw Pack Options.

Hinges are available in 1/2 pair (1 hinge) for 50% of the list price. Please use quantity (.5) when ordering.
All hinges supplied with screws. Non-Removable Pin (NRP) is available for additional \$6 Per pair (NET price).

STEEL HINGES - HEAVY DUTY, BALL BEARING

3 1/2" x 3 1/2" Heavy Duty
Square Corners



3 1/2" x 3 1/2" Heavy Duty
1/4" Radius Corners



4" x 4" Heavy Duty
5/8" Radius Corners



HEAVY DUTY HINGES - STEEL			List Price (Per Pair) Broken Case	List Price (Per Pair) 1 or More Cases	Hinges Per Case
Ball Bearing, Thickness: 0.122" - 0.134"		Product Code			
3 1/2" x 3 1/2" with Square Corners	94013	Polished Brass (US3) Satin Brass (US4) French Antique (US7) Oil Rubbed Bronze (US10B) Polished Nickel (US14) Satin Nickel (US15) Pewter (US15A) Flat Black (US19) Polished Chrome (US26) Medium Bronze (MB) Tumbled White Bronze (TWB)	\$38	\$36	24 (Pair)
4" x 4" with Square Corners	94014		\$40	\$38	24 (Pair)
4 1/2" x 4 1/2" with Square Corners	94015		\$44	\$40	24 (Pair)
3 1/2" x 3 1/2" with 1/4" Radius Corners	94023		\$38	\$36	24 (Pair)
4" x 4" with 1/4" Radius Corners	94024		\$40	\$38	24 (Pair)
4 1/2" x 4 1/2" with 1/4" Radius Corners	94025		\$44	\$40	24 (Pair)
3 1/2" x 3 1/2" with 5/8" Radius Corners	94033		\$38	\$36	24 (Pair)
4" x 4" with 5/8" Radius Corners	94034		\$40	\$38	24 (Pair)

>> See page 233 for Replacement Hinge Screw Pack Options.

Hinges are available in 1/2 pair (1 hinge) for 50% of the list price. Please use quantity (.5) when ordering. All hinges supplied with screws. Non-Removable Pin (NRP) is available for additional \$6 Per pair (NET price).

3 1/2" x 3 1/2" Residential Duty
Square Corners

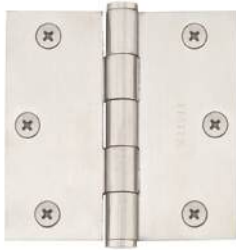

4" x 4" Residential Duty
1/4" Radius Corners



4" x 4" Residential Duty
5/8" Radius Corners



RESIDENTIAL DUTY HINGES - STAINLESS STEEL Plain Bearing, 304 Grade, Thickness: 0.093" - 0.096"		Product Code	Finish	List Price (Per Pair) Broken Case	List Price (Per Pair) 1 or More Cases	Hinges Per Case
3 1/2" x 3 1/2" with Square Corners	9811332D	Brushed Stainless Steel (SS)		\$36	\$30	24 (Pair)
4" x 4" with Square Corners	9811432D			\$40	\$38	24 (Pair)
3 1/2" x 3 1/2" with 1/4" Radius Corners	9812332D			\$36	\$30	24 (Pair)
4" x 4" with 1/4" Radius Corners	9812432D			\$40	\$38	24 (Pair)
3 1/2" x 3 1/2" with 5/8" Radius Corners	9813332D			\$36	\$30	24 (Pair)
4" x 4" with 5/8" Radius Corners	9813432D			\$40	\$38	24 (Pair)

>> To prevent corrosion, regular cleaning and maintenance should be performed to protect against environmental elements.

STAINLESS STEEL HINGES - HEAVY DUTY, PLAIN BEARING

3 1/2" x 3 1/2" Heavy Duty
Square Corners

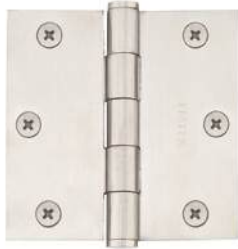

4" x 4" Heavy Duty
1/4" Radius Corners



4" x 4" Heavy Duty
5/8" Radius Corners



HEAVY DUTY HINGES - STAINLESS STEEL Plain Bearing, 304 Grade, Thickness: 0.113" - 0.135"		Product Code	Finish	List Price (Per Pair) Broken Case	List Price (Per Pair) 1 or More Cases	Hinges Per Case
3 1/2" x 3 1/2" with Square Corners	9821332D	Brushed Stainless Steel (SS)		\$38	\$36	24 (Pair)
4" x 4" with Square Corners	9821432D			\$47	\$44	24 (Pair)
4 1/2" x 4 1/2" with Square Corners	9821532D			\$59	\$53	24 (Pair)
3 1/2" x 3 1/2" with 1/4" Radius Corners	9822332D			\$38	\$36	24 (Pair)
4" x 4" with 1/4" Radius Corners	9822432D			\$47	\$44	24 (Pair)
3 1/2" x 3 1/2" with 5/8" Radius Corners	9823332D			\$38	\$36	24 (Pair)
4" x 4" with 5/8" Radius Corners	9823432D			\$47	\$44	24 (Pair)

>> To prevent corrosion, regular cleaning and maintenance should be performed to protect against environmental elements.

4" x 4" Heavy Duty
Square Corners



4" x 4" Heavy Duty
1/4" Radius Corners

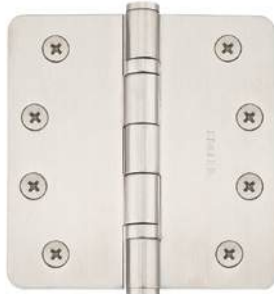

3 1/2" x 3 1/2" Heavy Duty
5/8" Radius Corners



HEAVY DUTY HINGES - STAINLESS STEEL Ball Bearing, 304 Grade, Thickness: 0.113" - 0.132"		Product Code	Finish	List Price (Per Pair) Broken Case	List Price (Per Pair) 1 or More Cases	Hinges Per Case
3 1/2" x 3 1/2" with Square Corners	9841332D	Brushed Stainless Steel (SS)		\$40	\$38	24 (Pair)
4" x 4" with Square Corners	9841432D			\$53	\$51	24 (Pair)
4 1/2" x 4 1/2" with Square Corners	9841532D			\$65	\$63	24 (Pair)
3 1/2" x 3 1/2" with 1/4" Radius Corners	9842332D			\$40	\$38	24 (Pair)
4" x 4" with 1/4" Radius Corners	9842432D			\$53	\$51	24 (Pair)
3 1/2" x 3 1/2" with 5/8" Radius Corners	9843332D			\$40	\$38	24 (Pair)
4" x 4" with 5/8" Radius Corners	9843432D			\$53	\$51	24 (Pair)

>> To prevent corrosion, regular cleaning and maintenance should be performed to protect against environmental elements.

Hinges are available in 1/2 pair (1 hinge) for 50% of the list price. Please use quantity (.5) when ordering.
All hinges supplied with screws. Non-Removable Pin (NRP) is available for additional \$6 Per pair (NET price).

SPRING HINGES - UL LISTED

3 ½" x 3 ½" Spring Hinge
¼" Radius Corners



4" x 4" Spring Hinge
Square Corners



4" x 4" Spring Hinge
⅝" Radius Corners



SPRING HINGES, UL LISTED - STEEL Plated Steel, Thickness: 0.110"		Product Code	Finish	List Price (Per Pair) Broken Case	List Price (Per Pair) 1 or More Cases	Hinges Per Case
3 ½" x 3 ½" with Square Corners	95013	Polished Brass (US3) Satin Brass (US4) French Antique (US7) Oil Rubbed Bronze (US10B) Polished Nickel (US14) Satin Nickel (US15) Pewter (US15A) Flat Black (US19) Polished Chrome (US26) Medium Bronze (MB) Tumbled White Bronze (TWB)		\$40	\$38	24 (Pair)
4" x 4" with Square Corners	95014			\$44	\$40	24 (Pair)
3 ½" x 3 ½" with ¼" Radius Corners	95023			\$40	\$38	24 (Pair)
4" x 4" with ¼" Radius Corners	95024			\$44	\$40	24 (Pair)
3 ½" x 3 ½" with ⅝" Radius Corners	95033			\$40	\$38	24 (Pair)
4" x 4" with ⅝" Radius Corners	95034			\$44	\$40	24 (Pair)

Hinges are available in ½ pair (1 hinge) for 50% of the list price. Please use quantity (.5) when ordering.
All hinges supplied with screws. Non-Removable Pin (NRP) is NOT available for Spring Hinges.

Flat Head Wood Screw - Steel
#9 x 3/4"



PRODUCT CODE REFERENCE	SCREW PART NUMBER	Finish	List Price	Pack Qty
91013	100PK-9FHWS75-B	Polished Brass (US3)	\$17	100
91014	100PK-9FHWS75-SB	Satin Brass (US4)		
91023	100PK-9FHWS75-FA	French Antique (US7)		
91024	100PK-9FHWS75-O	Oil Rubbed Bronze (US10B)		
91033	100PK-9FHWS75-PN	Polished Nickel (US14)		
91034	100PK-9FHWS75-N	Satin Nickel (US15)		
95013	100PK-9FHWS75-P	Pewter (US15A)		
95014	100PK-9FHWS75-FB	Flat Black (US19)		
96113	100PK-9FHWS75-C	Polished Chrome (US26)		
96114	100PK-9FHWS75-MB	Medium Bronze (MB)		
96123	100PK-9FHWS75-TWB	Tumbled White Bronze (TWB)		
96124				
96133				
96134				

Flat Head Wood Screw - Steel
#10 x 1"



PRODUCT CODE REFERENCE	SCREW PART NUMBER	Finish	List Price	Pack Qty
92013	100PK-10FHWS10-B	Polished Brass (US3)	\$19	100
92023	100PK-10FHWS10-SB	Satin Brass (US4)		
92033	100PK-10FHWS10-FA	French Antique (US7)		
94013	100PK-10FHWS10-O	Oil Rubbed Bronze (US10B)		
94023	100PK-10FHWS10-PN	Polished Nickel (US14)		
94033	100PK-10FHWS10-N	Satin Nickel (US15)		
95023	100PK-10FHWS10-P	Pewter (US15A)		
95024	100PK-10FHWS10-FB	Flat Black (US19)		
95033	100PK-10FHWS10-C	Polished Chrome (US26)		
95034	100PK-10FHWS10-MB	Medium Bronze (MB)		
96213	100PK-10FHWS10-TWB	Tumbled White Bronze (TWB)		
96223				
96233				
96313				
96413				
96513				

Flat Head Wood Screw - Steel
#12 x 1 1/4"



PRODUCT CODE REFERENCE	SCREW PART NUMBER	Finish	List Price	Pack Qty
92014 96224	100PK-12FHWS13-B	Polished Brass (US3)	\$24	100
92015 96225	100PK-12FHWS13-SB	Satin Brass (US4)		
92024 96234	100PK-12FHWS13-FA	French Antique (US7)		
92025 96414	100PK-12FHWS13-O	Oil Rubbed Bronze (US10B)		
92034 96415	100PK-12FHWS13-PN	Polished Nickel (US14)		
94014 96416	100PK-12FHWS13-N	Satin Nickel (US15)		
94015 96425	100PK-12FHWS13-P	Pewter (US15A)		
94024 96315	100PK-12FHWS13-FB	Flat Black (US19)		
94025 96514	100PK-12FHWS13-C	Polished Chrome (US26)		
94034 96515	100PK-12FHWS13-MB	Medium Bronze (MB)		
96214	100PK-12FHWS13-TWB	Tumbled White Bronze (TWB)		
96215				

>>> Bulk Pack Screws NOT available in Stainless Steel.

REPLACEMENT PARTS FOR F20 & F13 MORTISE LOCKS

			
Steel Understrike Supplied with all Mortise Locks	Brass Standard Strike Plate 1 7/8" wide x 4 7/8" high Supplied with Mortise Locks unless door thickness is specified as 2" or greater	Brass Flat Strike Plate 1 7/8" wide x 4 7/8" high Supplied with Mortise Locks when requested	Brass Extended Strike Plate 2 1/2" wide x 4 7/8" high Supplied with Mortise Locks when door thickness is specified as 2" or greater

ADDITIONAL STRIKE PLATES (F20 & F13)	Product Code	Finish	List Price
Brass Standard Strike Plate with understrike and screws	86147	Polished Brass - Lifetime (US3) Satin Brass (US4) French Antique (US7) Oil Rubbed Bronze (US10B) Satin Nickel (US15) Pewter (US15A) Flat Black (US19)	\$26
Brass Flat Strike Plate with understrike and screws	86148	Polished Chrome (US26) Medium Bronze (MB) Tumbled White Bronze (TWB) Unlacquered Brass (US3NL)*	\$26
Brass Extended Strike Plate with understrike and screws	86149	Polished Chrome (US26) Medium Bronze (MB) Tumbled White Bronze (TWB) Unlacquered Brass (US3NL)*	\$26
Steel Understrike	83227		\$17

MORTISE LOCK BOX ONLY Includes Face Plate, Strike Plate and Screws Cylinder Not Included.	Product Code	Backset	Handing	Finish	List Price
Thumb by Lever or Knob	3300	2 1/2" or 2 3/4"	LH/RH	Polished Brass - Lifetime (US3) Satin Brass (US4) French Antique (US7) Oil Rubbed Bronze (US10B) Satin Nickel (US15) Pewter (US15A) Flat Black (US19)	\$313
Knob by Knob & Lever by Lever				Polished Chrome (US26) Medium Bronze (MB) Tumbled White Bronze (TWB) Unlacquered Brass (US3NL)*	
	3380	2 1/2" or 2 3/4"	LH/RH	Polished Chrome (US26) Medium Bronze (MB) Tumbled White Bronze (TWB) Unlacquered Brass (US3NL)*	\$313

CYLINDER WITH CAP	Product Code	Length	Finish	List Price
Threaded Mortise	THRDCY1375	1 3/8"	Polished Brass - Lifetime (US3) Satin Brass (US4)	\$46
	THRDCY150	1 1/2"	French Antique (US7) Oil Rubbed Bronze (US10B)	\$46
	THRDCY175	1 3/4"	Satin Nickel (US15) Pewter (US15A)	\$46
	THRDCY200	2"	Flat Black (US19) Polished Chrome (US26) Flat Black Bronze (FB) Medium Bronze (MB) Tumbled White Bronze (TWB) Brushed Stainless Steel (SS) Unlacquered Brass (US3NL)*	\$190

- **Handing is Required for ALL Mortise Locks**
- Standard door thickness of 1 3/4". Specify if thicker.
- Locks for in-swing doors are standard. For out-swing doors, please specify.

*Unlacquered Brass (US3NL) finish available for a **\$10 List Price** upcharge per item.

Drive-in Latch



DRIVE-IN LATCHES	Product Code	Finish	List Price
Passage Latch, 2 $\frac{3}{8}$ " backset	LC4-PASDV2375	Please specify Brass or Chrome nose bolt.	\$16
Privacy Latch, 2 $\frac{3}{8}$ " backset	LC4-PRVDV2375		\$16
Passage Latch, 2 $\frac{3}{4}$ " backset	LC4-PASDV275		\$16
Privacy Latch, 2 $\frac{3}{4}$ " backset	LC4-PRVDV275		\$16

Deadbolt Latch



DEADBOLT LATCHES	Product Code	Finish	List Price
2 $\frac{3}{8}$ " backset	LC4-DBLCH237	Polished Brass (US3) Satin Brass (US4)	\$16
2 $\frac{3}{8}$ " backset, Radius Corners	LC4-DBLCH237R	French Antique (US7) Oil Rubbed Bronze (US10B)	\$16
2 $\frac{3}{4}$ " backset	LC4-DBLCH275	Polished Nickel (US14) Satin Nickel (US15) Pewter (US15A)	\$16
2 $\frac{3}{4}$ " backset, Radius Corners	LC4-DBLCH275R	Flat Black (US19) Polished Chrome (US26) Medium Bronze (MB) Tumbled White Bronze (TWB) Unlacquered Brass (US3NL)*	\$16

Key In Latch



KEY IN LATCHES	Product Code	Finish	List Price
2 $\frac{3}{8}$ " backset	LC4-DLB2375	Polished Brass (US3) Satin Brass (US4)	\$16
2 $\frac{3}{8}$ " backset, Radius Corners	LC4-DLB2375R	French Antique (US7) Oil Rubbed Bronze (US10B)	\$16
2 $\frac{3}{4}$ " backset	LC4-DLB275	Polished Nickel (US14) Satin Nickel (US15) Pewter (US15A)	\$16
2 $\frac{3}{4}$ " backset, Radius Corners	LC4-DLB275R	Flat Black (US19) Polished Chrome (US26) Medium Bronze (MB) Tumbled White Bronze (TWB) Unlacquered Brass (US3NL)*	\$16

*Unlacquered Brass (US3NL) finish available for a \$5 List Price upcharge per item.

EMPowered™ Motorized Deadbolt Latch



EMPOWERED™ MOTORIZED DEADBOLT LATCHES	Product Code	Finish	List Price
2 $\frac{3}{8}$ " backset	LC9-DBLCH237EMPWR	Oil Rubbed Bronze (US10B) Satin Nickel (US15)	\$24
2 $\frac{3}{4}$ " backset	LC9-DBLCH275EMPWR	Flat Black (US19) Polished Chrome (US26)	\$24

>> EMPowered™ Deadbolt only available with square corner latch face plate.

Standard Latch



STANDARD LATCHES	Product Code		List Price
Passage Latch, 2¾" backset	LC4-PASS M 237	Please specify Brass or Chrome nose bolt.	\$16
Privacy Latch, 2¾" backset	LC4-PRIV M 237		\$16
Passage Latch, 2¾" backset	LC4-PASS M 275		\$16
Privacy Latch, 2¾" backset	LC4-PRIV M 275		\$16

28° Rotation Latch



28 DEGREE ROTATION LATCHES	Product Code		List Price
Passage Latch, 2¾" backset	LC4-PAS28B237	Please specify Brass or Chrome nose bolt.	\$24
Privacy Latch, 2¾" backset	LC4-PRV28B237		\$24
Passage Latch, 2¾" backset	LC4-PAS28B275		\$24
Privacy Latch, 2¾" backset	LC4-PRV28B275		\$24

• 28° rotation latch is designed to work with a corresponding door mechanism and cannot be retrofitted.

FACEPLATE & SCREWS FOR STANDARD OR 28 DEGREE ROTATION LATCHES	Product Code	Finish	List Price
Passage/Privacy, Square Corners	83230	Polished Brass (US3) Satin Brass (US4) French Antique (US7)	\$7
Passage/Privacy, Radius Corners	83231	Oil Rubbed Bronze (US10B) Polished Nickel (US14) Satin Nickel (US15) Pewter (US15A) Flat Black (US19) Polished Chrome (US26) Satin Rose Gold (SRG) Matte White (MW) Medium Bronze (MB) Tumbled White Bronze (TWB) Brushed Stainless Steel (SS) Unlacquered Brass (US3NL)*	\$7

*Unlacquered Brass (US3NL) finish available for a \$5 List Price upcharge per item.

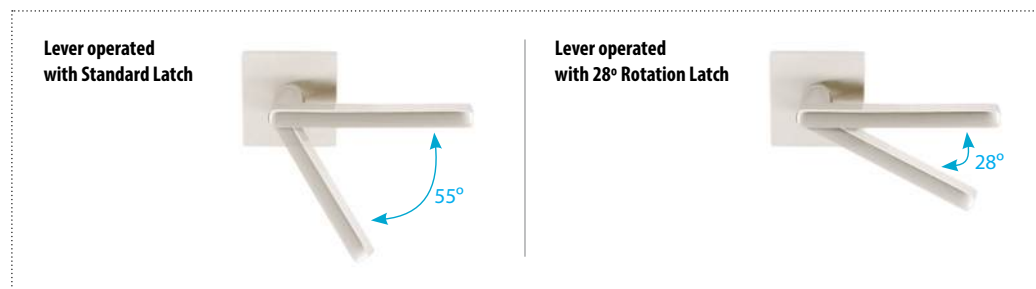

• Knobsets, leversets and platesets ordered with 28° rotation Latches are assembled with internal components specifically designed for use ONLY with our 28° rotation latch.

Tubular Pocket Door Privacy Latch



TUBULAR POCKET DOOR PRIVACY LATCH	Product Code	Finish	List Price
2 3/8" backset	LC6-TUBPKTLATCH	Polished Brass (US3) Polished Chrome (US26)	\$24

FACEPLATE & SCREWS FOR TUBULAR POCKET DOOR PRIVACY LATCH	Product Code	Finish	List Price
Passage/Privacy, Square Corners	83228	Polished Brass (US3) Satin Brass (US4) Oil Rubbed Bronze (US10B)	\$7
Passage/Privacy, Radius Corners	83229	Polished Nickel (US14) Satin Nickel (US15) Pewter (US15A) Flat Black (US19) Polished Chrome (US26) Unlacquered Brass (US3NL)*	\$7

Thumbturn Privacy Latch



THUMBTURN PRIVACY LATCHES	Product Code	Finish	List Price
Privacy Latch, 2 3/8" backset	LC4-PRIDB238	Polished Brass (US3) Satin Brass (US4)	\$16
Privacy Latch, 2 3/4" backset	LC4-PRIDB275	French Antique (US7) Oil Rubbed Bronze (US10B) Polished Nickel (US14) Satin Nickel (US15) Pewter (US15A) Flat Black (US19) Polished Chrome (US26) Unlacquered Brass (US3NL)*	\$16
THUMBTURN PRIVACY DEADBOLT STRIKE PLATE	Product Code		List Price
1" x 2 1/4"	83226		\$8

*Unlacquered Brass (US3NL) finish available for a \$5 List Price upcharge per item.

>> Thumbturn Privacy Latches only available with square corner latch face plate.

**Standard
Deadbolt Strike Plate**



**Heavy Duty
Deadbolt Strike Plate**



**Heavy Duty Full Lip
Deadbolt Strike Plate**



STANDARD DEADBOLT STRIKE PLATE Supplied with 4 Screws: (2) #10, 2 1/2" Wood Screws (2) #10, 3/4" Wood Screws		Product Code	Finish	List Price
Standard, Square Corners 1 1/8" x 2 3/4", 2 1/8" C-to-C	83223	Polished Brass (US3) Satin Brass (US4) French Antique (US7) Oil Rubbed Bronze (US10B) Polished Nickel (US14) Satin Nickel (US15) Pewter (US15A) Flat Black (US19) Polished Chrome (US26) Medium Bronze (MB) Tumbled White Bronze (TWB) Unlacquered Brass (US3NL)*		\$9
Standard, 1/4" Radius Corners 1 1/8" x 2 3/4", 2 1/8" C-to-C	83224			\$9
HEAVY DUTY DEADBOLT STRIKE PLATE Supplied with 4 Screws: (2) #10, 2 1/2" Wood Screws (2) #10, 3/4" Wood Screws				Product Code
Heavy Duty 1 1/4" x 3 5/8", 3/4" Fits Kwikset® Type Jamb Prep	93223			\$9
Heavy Duty Full Lip 1 7/8" x 3 5/8", 3/4" Full Lip Deadbolt Strike	93224			\$9

*Unlacquered Brass (US3NL) finish available for a \$5 List Price upcharge per item.

>> Strike plates must be purchased separately. If ordered along with deadbolts they will be packed into the deadbolt boxes. In that case deadbolts will be packed with both normal strikes and heavy duty strikes.

STEEL UNDERSTRIKE FOR DEADBOLT Supplied with 4 Screws:		Product Code	List Price
Standard, 1/4" Radius Corners 1 1/8" x 2 3/4", 2 1/8" C-to-C	83225		\$6

**Full Lip Strike
Square Corner**

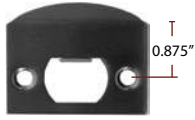

**Full Lip Strike
¼" Radius Corner**



**Extended Lip Strike
Square Corner**

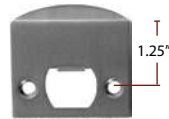

**T Strike
Square Corner**



HEAVY DUTY STRIKE PLATES For Key In and Passage & Privacy Sets	Product Code	Finish	List Price
Full Lip Strike, Square Corners	86084	Polished Brass (US3) Satin Brass (US4)	\$9
Full Lip Strike, ¼" Radius Corners	86085	French Antique (US7) Oil Rubbed Bronze (US10B) Polished Nickel (US14)	\$9
Extended Lip Strike, Square Corners	86086	Satin Nickel (US15) Pewter (US15A) Flat Black (US19)	\$9
T Strike, Square Corners	86087	Polished Chrome (US26) Matte White (MW) Medium Bronze (MB) Satin Rose Gold (SRG) Tumbled White Bronze (TWB) Unlacquered Brass (US3NL)*	\$9

***Unlacquered Brass (US3NL)** finish available for a **\$5 List Price** upcharge per item.

>> Full Lip Strike Square Corners plates are standard. Full Lip Strike ¼" Radius Corners, Extended Lip Strike and T Strike plates may be substituted at no extra charge.
>> Extended Lip Strike and T Strike plates **NOT** available with radius corners.



EMERGENCY RELEASE TOOLS	Product Code	Finish	List Price
Emergency Release Key with Finish Matching Plug	KIT-PRIV-106	Polished Brass - Lifetime (US3) Satin Brass (US4) French Antique (US7) Oil Rubbed Bronze (US10B) Polished Nickel - Lifetime (US14) Satin Nickel (US15) Pewter (US15A) Flat Black (US19) Polished Chrome (US26) Unlacquered Brass (US3NL)*	\$8
Emergency Release Coin Pack of 3	KIT-PRIV-104		\$8
Emergency Release Tool Pack of 5	KIT-PRIV-103		\$8

***Unlacquered Brass (US3NL)** finish available for a **\$5 List Price** upcharge per item.

REPLACEMENT PARTS

CHARGE FOR RE-KEYING - \$3 (NET) PER CYLINDER

- Keying to Code
 - Order by indicating "**Key Code XXXXX**" next to applicable locks
- Keying Alike
 - Order by indicating "**Keyed Alike**" next to applicable locks if only one keyed alike group is wanted
 - If ordering multiple groups (houses) indicate "**Keyed Alike House #_**" next to applicable locks

CHARGE FOR CONSTRUCTION KEYING - \$4 (NET) PER CYLINDER

- Locks that are both construction keyed and keyed alike in a house group will be charged a total of **\$7 (NET) per cylinder**
- Lost ball system
- Last four pin locations drilled for lost ball application
- Master key pins used for code variability
- Construction keys and owner keys sent separately
- Order by indicating "**Construction Keyed, House #_**" next to applicable locks

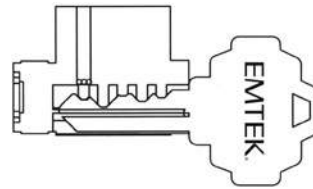

Construction devices used on one or more of last four positions

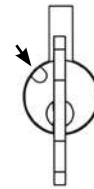

Dimples drilled in plug in this position



Thru-Bore Dummy Mounting Kit

8900	List Price
Thru-Bore Dummy Mounting Kit	\$24

>> Specify Lever/Knob and Rosette styles when ordered.

CY4	List Price
Cylinder (Each)	\$19

>> Specify function and finish.

Key Blanks	List Price
MS4-KEYBLKC Schlage® C Keyway	\$3
MS4-WEISERKYBLKC Weiser® (WR5) Keyway	\$3



FS16	List Price
Finish Ring (Each)	\$17



DUST BOX	Product Code	List Price
For Use with Emtek Strikes Key in and Passage & Privacy Sets	MP6-TUPKDUSTCVR	\$4

COLLECTION	PAGE
ELECTRONIC LOCKSETS	
Classic	40, 41
EMPowered™ 2	28-37
EMTouch™	38, 40, 41
EMTouch™ Classic	38, 40, 41
Modern	40, 41
Sandcast Bronze	38, 40, 41

MORTISE ENTRY SETS

Adelaide	46
Albany	51
Artemis	47
Brisbane	46
Charleston	51
Cheyenne	56
Craftsman	53
Craftsman Full Length	53
Da Vinci	57
Denver	56
Harrison	49
Hera	47
Hercules Knurled	44
Hercules Smooth	43
Longmont	54
Lugano	45
Manhattan	48
Melrose	48
Memphis	50
Middleton	49
Mormont	45
Mormont - Stainless Steel	58
Octagon	57
Rectangular Full Length	55
Rectangular Monolithic	55
Rectangular Sectional	55
Regency	52
Rustic Modern Rectangular	54
Sonoma	54
Topeka	56
Transitional Heritage	50

COLLECTION	PAGE
Versailles	52
MORTISE KNOB BY KNOB, LEVER BY LEVER ENTRY SETS	
Artemis	59
Brisbane	59
Charleston	60
Cheyenne	62
Craftsman	61
Da Vinci	63
Hailey	62
Harrison	60
Manhattan	60
Memphis	61
Mormont	59
Mormont - Stainless Steel	63
Octagon	63
Rectangular	62
Regency	61

TUBULAR ENTRY SETS

Adams	69
Apollo	67
Ares	67
Art Nouveau	81
Arts & Crafts	75
Arts & Crafts Full Length	75
Baden	66
Brighton	77
Davos	66
Davos - Stainless Steel	84
Denver	79
Franklin	69
Greeley	79
Hamden	70
Imperial	74
Jefferson	69
Knoxville	73
Hercules Knurled Full Length	65
Hercules Knurled Monolithic	65

INDEX BY COLLECTION

COLLECTION	PAGE
Hercules Knurled Sectional	65
Hercules Smooth Full Length	64
Hercules Smooth Monolithic	64
Hercules Smooth Sectional	64
Lausanne	66
Logan	77
Marietta	72
Melrose	70
Monolithic with Lafayette Grip	83
Monolithic with Normandy Grip	83
Monolithic with San Carlos Grip	83
Nashville	71
Octagon	81
Orion	67
Orleans	73
Rectangular Full Length	78
Rectangular Monolithic	78
Rectangular Sectional	78
Remington	79
Ribbon & Reed	74
Richmond	71
Ridgemont	77
Rustic Modern Rectangular Full Length	76
Rustic Modern Rectangular Monolithic	76
Rustic Modern Rectangular Sectional	76
Saratoga	72
Sectional with Lafayette Grip	82
Sectional with Normandy Grip	82
Sectional with San Carlos Grip	82
Transitional Heritage Monolithic	68
Transitional Heritage Sectional	68
Tuscany Monolithic	80
Tuscany Sectional	80
Urban Modern Sectional	68
Wilmington	71
Wilshire	70

GRIP BY GRIP ENTRY SETS

Brighton	85
Logan	85

COLLECTION	PAGE
Ridgemont	85
Rustic Rectangular Full Length	85
Rustic Rectangular Monolithic	85
Rustic Rectangular Sectional	85

KEY IN ENTRY SETS

Cortina Key In Lever	89
Durango Key In Lever	90
Egg Key In Knob	89
Hanover Key In Lever	88
Hanover Key In Lever - Stainless Steel	91
Helios Key In Lever	88
Hercules Key In Lever	88
Luzern Key In Lever	88
Petal Key In Knob	91
Providence Key In Knob	89
Rope Key In Knob	89
Rope Key In Lever	89
Round Key In Knob	88
Siena Key In Lever	91
SELECT Key In Lever	86
Waverly Key In Knob	89
Winchester Key In Knob	90

SINGLE AND TWO POINT LOCKSETS

Annapolis	94
SELECT Single & Two-Point	92
Modern Rectangular	93

DEADBOLTS & SINGLE SIDED

DEADBOLTS

#8	97
#8, Single Sided	102
Arts & Crafts	98
Arts & Crafts, Single Sided	102
Knoxville	98
Knoxville, Single Sided	102
Low Profile	96
Modern	95
Modern Disc	95

COLLECTION	PAGE
Modern Disc, Single Sided	102
Modern, Single Sided	102
Neos	95
Neos, Single Sided	102
Quincy	96
Quincy, Single Sided	102
Rectangular	97
Rectangular, Single Sided	102
Regular	96
Regular, Single Sided	102
Rope	98
Rope, Single Sided	102
Sandcast Bronze - #1	99
Sandcast Bronze - #1, Single Sided	103
Sandcast Bronze - #2, Single Sided	103
Sandcast Bronze - #3	99
Sandcast Bronze - #3, Single Sided	103
Sandcast Bronze - #4, Single Sided	103
Sandcast Bronze - Regular	99
Sandcast Bronze - Ridgemont	99
Sandcast Bronze - Rustic Modern	99
Rectangular	97
Saratoga	97
Saratoga, Single Sided	102
Square	95
Square, Single Sided	102
Stainless Steel - Modern Disc	101
Stainless Steel - Modern Disc, Single Sided	103
Stainless Steel - Round	101
Stainless Steel - Round, Single Sided	103
Stainless Steel - Square	101
Stainless Steel - Square, Single Sided	103
Tuscany Bronze	100
Tuscany Bronze - #11	100
Tuscany Bronze - #11, Single Sided	103
Tuscany Bronze - #14	100
Tuscany Bronze - #14, Single Sided	103
Tuscany Bronze - Classic	100
Tuscany Bronze - Classic, Single Sided	103
Tuscany Bronze - Octagon	100

COLLECTION	PAGE
Tuscany Bronze - Octagon, Single Sided	103
Urban Modern	96
Urban Modern, Single Sided	102
Wilshire	96
Wilshire, Single Sided	102
Wrought Steel - #1	101
Wrought Steel - #1, Single Sided	103
Wrought Steel - #2	101
Wrought Steel - #2, Single Sided	103
Wrought Steel - #3	101
Wrought Steel - #3, Single Sided	103

SIDEPLATE LOCKSETS

Belmont	112
Colonial	109
Delaware	108
Missoula	113
Modern	106
Quincy	107
Rope	110
Sandcast Bronze #5	115
Sandcast Bronze Rectangular	114
SELECT Sideplate	105
Stainless Steel	117
Tuscany Bronze #16	116
Victoria	112
Wilshire	111
Wrought Steel #5	117

THUMBTURN PRIVACY LOCKSETS

Belmont	118
Colonial	118
Delaware	118
Modern	118
Quincy	118
Rope	118
Victoria	118

COLLECTION	PAGE
STRETTO NARROW TRIM LOCKSETS	
1.5" x 3" Oval	128
1.5" x 5" Modern Rectangular	129
Concord	121
Modern Rectangular	120
Sandcast Bronze Arched	122
Sandcast Bronze Rectangular	123
SELECT Stretto	126
Stainless Steel	125
Tuscany Bronze	124
PASSAGE/PRIVACY LEVERSETS	
Argos	144
Arts & Crafts	159
Aston	144
Athena	142
Athena - Stainless Steel	161
Aurora	162
Basel	144
Breslin	144
Bryce	162
Cimarron	162
Cody	162
Cologne - Stainless Steel	161
Cortina	148, 149
Coventry	152, 153
Dresden - Stainless Steel	161
Dumont	144
Durango	162
Elan	152, 153
Freestone	144
Geneva	144
Hammered	159
Helios	142
Helios - Stainless Steel	161
Hercules	145
Hercules - Stainless Steel	161
Hermes	142
Hermes - Stainless Steel	161
Interior Mortise	130 - 131

COLLECTION	PAGE
Kiel - Stainless Steel	161
Lafayette	168
Lariat	162
Luzern	142
Manning	148, 149
Mariposa	162
Medici	166
Mercury	145
Merrimack	148, 149
Milano	148, 149
Montrose	162
Myles	145
Napoli	166
Normandy	168
Octagon	166
Padua	166
Poseidon	142
Poseidon - Stainless Steel	161
Ribbon & Reed	152, 153
Rope	152, 153
Rustic	152, 153
San Carlos	168
Santa Fe	152, 153
SELECT Levers	132-135
Sion	145
Spencer	145
Stuttgart	142
Stuttgart - Stainless Steel	161
Teton	162
Triton	145
Turino	148, 149
Wembley	152, 153
Yuma	162
PASSAGE/PRIVACY KNOBSETS	
Astoria Glass	156, 157, 164
Belmont	154, 155
Bern	146
Bristol Glass	147, 156, 157, 164
Butte	163

COLLECTION	PAGE
Diamond Glass	156, 157, 164
Ebony Porcelain	158
Egg	150, 151
Egg - Sandcast Bronze	163
Freestone	146
Georgetown Glass	156, 157, 164
Hammered Egg	146, 159
Hampton Glass	147, 156, 157, 164
Ice White Porcelain	158
Jamestown	169
Lancaster	154, 155
Laurent	146
Lowell Glass	156, 157, 164
Madison Black	169
Madison Ivory	169
Melon	150, 151
Modern Disc Glass	147, 165
Modern Square Glass	147, 165
Norwich	150, 151
Octagon	146
Octagon - Tuscany Bronze	161
Octagon - Stainless Steel	167
Old Town Glass	156, 157, 165
Orb	143
Parma	167
Petal	167
Providence	150, 151
Providence Glass	156, 157, 165
Ribbon & Reed	154, 155
Rope	154, 155
Round	143
Round - Sandcast Bronze	163
Round - Stainless Steel	161
Savannah	169
SELECT Knobs	136, 137
Square	146
Studio Brass	140, 141
Verve	146
Victoria	154, 155
Waverly	150, 151

COLLECTION	PAGE
Winchester	163
Windsor Glass	147, 156, 157, 165

THUMBTURN PRIVACY BOLT FOR PASSAGE SETS

Classic	160
Disk	160
Mix Match	138, 139
Modern	160
Square	160
Watford	160
Wilshire	160

BARN DOOR HARDWARE

Classic Face Mount	177
Classic Face Mount - SS	179
Classic Top Mount	177
Classic Top Mount - SS	179
Low Profile Concealed	173
Low Profile Concealed - SS	173
Modern Rectangular Barn Door	171
Privacy Locks	
Modern Rectangular Face Mount	176
Modern Rectangular Face Mount - SS	178
Modern Rectangular Top Mount	176
Modern Rectangular Top Mount - SS	178

LONG DOOR PULLS

24" & 36" Door Pulls	181
48" & 72" Door Pulls	181
European Mortise Deadbolt with	182
Integrated Roller Latch	

CABINET APPLIANCE PULLS

Alexander	186
Bar	187
Bauhaus	187
Blythe	188
Fluted Tuscany Bronze	188

COLLECTION	PAGE
Freestone	186
Habitat	187
Jasper	186
Keaton	186
Mod Hex	186
Rail Sandcast Bronze	188
Riviera	187
Rustic Modern Rectangular	188
SELECT Appliance	184
SELECT Bar Appliance	185
Spindle	188
Trail	187
Tribeca	186
Trinity	187
Warwick	186
Westridge	187
Westwood	188

DOOR PULLS

8", 13¾" and 18" Rod Bronze	191
18" and 24" San Carlos	193
8" Hercules Knurled	189
8" Hercules Smooth	189
8" Art Nouveau	192
8" Arts & Craft	189
8" Baden	189
8" Baden - Stainless Steel	189
8" Brisbane	189
8" Column	192
8" Knoxville	189
8" Lafayette	193
8" Normandy	193
8" Nunez	191
8" Palermo	192
8" Recoleta	192
8" Ribbon & Reed	189
8" Rustic Modern Arched	191
8" San Carlos	193
8" Twig	191
8" Twist	192

COLLECTION	PAGE
8" Urban Modern	189
8" Wilshire	189
8 ¾" Rustic Modern Rectangular	191
Knoxville Push/Pull Plate	190
Modern Push/Pull Plate	190
Modern Rectangular Flush Pull for Door Pull	190
Petal Push/Pull Plate	192

**POCKET DOOR MORTISE/
TUBULAR LOCKS**

Pocket Door Lock	199
Pocket Door Lock - Modern Rectangular	199
Pocket Door Mortise Lock - #8	195
Pocket Door Mortise Lock - Classic	197
Pocket Door Mortise Lock - Knurled Narrow Modern Rectangular	196
Pocket Door Mortise Lock - Modern Rectangular	197
Pocket Door Mortise Lock - Narrow Modern Rectangular	196
Pocket Door Mortise Lock - Narrow Oval	196
Pocket Door Mortise Lock - Round	195
Pocket Door Mortise Lock - Sandcast Bronze	197
Rustic Modern Rectangular	195
Pocket Door Mortise Lock - Square	198
Pocket Door Tubular Lock - #8	198
Pocket Door Tubular Lock - Rectangular	198
Pocket Door Tubular Lock - Round	198
Pocket Door Tubular Lock - Square	198

DOOR ACCESSORIES

3 Hooks with Sandcast Bronze	213
Ball Catch	204
Baseboard Door Bumper	207
Cabinet Latch	203
Casement Latch	204

COLLECTION	PAGE	COLLECTION	PAGE
Cylinder Floor Bumper	208	Sandcast Bronze Robe Hook	214
Cylinder Floor Bumper with Dome Cap	208	Screen Door Lock	210
Door Bell	216 - 218	SELECT Hooks	211
Door Knocker - Bronze with Ring Pull	209	Single Hook - Modern Tubular	212
Door Knocker - Solid Brass Urn	209	Single Hook - Sandcast Bronze	214
Door Stop	207	Single Hook - Stainless Steel	214
Door Stop - Goose Style	208	Single Hook - Traditional Brass	212
Door Stop - Half Dome	208	Single Hook - Transitional Brass	213
Door Viewer	209	Single Hook - Transitional Flared	212
Double Hook - Solid Brass	213	Single Hook - Tuscany Bronze	214
Double Hook - Traditional Brass	213	Single Robe Hook - Modern Tubular	212
Double Hook - Tuscany Bronze	214	Solid Brass Robe Hook	213
Double Hook with Rosette - Modern Brass	212	Square Floor Bumper	208
Double Hook with Rosette - Traditional Brass	213	Surface Bolt	205
Dutch Door Bolt	205	Wall Bumper	209
Edge Pull	203	Window Utility Pull	203
Extendable Baseboard Door Bumper	207		
Floor Door Bumper	207	HINGES	
Flush Bolt	206	Ball Tip for Solid Brass Hinge	224
Flush Pull - #8	201	Button Tip for Solid Brass Hinge	225
Flush Pull - Classic Rectangular	202	Extended Button Tip	225
Flush Pull - Modern Rectangular	200	Hinge Screws	233
Flush Pull - Modern Rectangular Knurled	200	Hinges Pivot Stop	225
Flush Pull - Modern Rectangular with Surface Screws	202	SELECT Hinge Tips	223
Flush Pull - Narrow Oval	202	Solid Brass Hinge	220 - 222
Flush Pull - Rectangular	201	Spring Hinge	232
Flush Pull - Rectangular with Offset Pocket	201	Square Barrel Hinge	219
Flush Pull - Round	201	Stainless Steel Hinge	229 - 231
Flush Pull - Round with Half Moon Pocket	201	Steel Hinge	226 - 228
Flush Pull - Sandcast Bronze Modern Rectangular	202	Steeple Tips	224
Flush Pull - Square	201		
Heavy Duty Roller Latch	204		
House Number - 7" Modern	215		
Jamb Bolt	206		
Jamb Bolt - Modern Rectangular	206		
Magnetic Door Stop & Holder	207		
Mail Slot	209		
Mail Slot Sleeve	209		
Patio Door Bolt	206		
Roller Catch	204		

INDEX

PRODUCT CODE	PAGE	PRODUCT CODE	PAGE	PRODUCT CODE	PAGE
443	64, 65, 66, 67, 68, 69, 70, 71, 72, 73, 74, 75, 76, 77, 78, 79, 80, 81, 83, 84, 106, 107, 108, 109, 110, 111, 113, 114, 115, 116, 117	2165	196	2290	210
818TP	160	2166	196	2291	210
828TP	160	2174	195	2295	212
2014	198	2175	195	2306	214
2015	198	2176	195	2307	213
2016	198	2184	195	2308	214
2034	198	2185	195	2400	216
2035	198	2186	195	2401	216
2036	198	2193	196	2402	216
2043	195	2194	196	2403	216
2044	195	2195	196	2404	216
2045	195	2196	196	2406	216
2046	195	2206	201	2407	216
2050	182	2212	202	2408	216
2051	182	2213	201	2409	216
2101	199	2215	202	2411	218
2102	199	2216	202	2412	218
2103	197	2219	206	2414	218
2104	197	2220	206	2415	218
2105	197	2221	203	2421	218
2106	197	2231	207	2422	218
2107	199	2232	207	2423	218
2108	199	2233	207	2424	218
2113	197	2234	208	2425	218
2114	197	2235	208	2431	218
2115	197	2237	207	2432	218
2116	197	2241	225	2433	218
2123	197	2242	225	2440	217
2124	197	2244	203	2441	217
2125	197	2246	203	2442	217
2126	197	2251	208	2451	216
2134	198	2253	208	2452	216
2135	198	2254	207	2457	216
2136	198	2255	209	2458	216
2144	198	2256	207	2459	216
2145	198	2257	208	2460	216
2146	198	2258	208	2463	216
2153	196	2259	208	2465	216
2154	196	2260	208	2466	216
2155	196	2266	211	2606	213
2156	196	2267	211	2607	213
2163	196	2268	211	2608	213
2164	196	2270	203	2609	213
		2280	209	2610	209
		2281	209	2620	209
		2285	212	2706	214
		2286	212	2707	214

PRODUCT CODE	PAGE	PRODUCT CODE	PAGE	PRODUCT CODE	PAGE
2809	212	3106	60	3502	61
2830	215	3107	61	3506	60
2831	215	3108	61	3507	61
2832	215	3121	62	3508	61
2833	215	3125	62	3521	62
2834	215	3131	63	3525	62
2835	215	3133	63	3531	63
2836	215	3134	62	3533	63
2837	215	3143	60	3534	62
2838	215	3144	59	3543	60
2839	215	3145	59	3544	59
2909	212	3151	60	3545	59
3002	50	3300	234	3551	60
3005	48	3302	50	4041	122
3006	48	3305	48	4042	122
3007	52	3306	48	4043	122
3008	53	3307	52	4044	122
3009	52	3308	53	4045	122
3017	46	3309	52	4046	122
3018	46	3311	46	4141	122
3019	59	3312	46	4143	122
3021	56	3313	59	4201	70
3022	56	3321	56	4202	70
3023	56	3322	56	4203	70
3024	55	3323	56	4204	64
3025	55	3324	55	4205	64
3026	55	3325	55	4206	64
3029	54	3326	55	4207	65
3030	54	3329	54	4208	65
3031	57	3330	54	4209	65
3033	57	3331	57	4211	70
3035	43	3333	57	4212	70
3036	43	3335	43	4213	70
3037	44	3336	43	4214	64
3038	44	3337	44	4215	64
3039	50	3338	44	4216	64
3040	54	3339	50	4217	65
3043	51	3340	54	4218	65
3044	47	3343	51	4219	65
3045	47	3344	47	4221	70
3047	45	3345	47	4222	70
3048	45	3347	45	4223	70
3049	53	3348	45	4224	64
3050	51	3349	53	4225	64
3051	49	3350	51	4226	64
3052	49	3351	50	4227	65
3102	61	3352	49	4228	65
		3380	234		

PRODUCT CODE	PAGE
4229	65
4241	122
4243	122
4300	73
4301	73
4302	71
4303	71
4304	71
4310	73
4311	73
4312	71
4313	71
4314	71
4320	73
4321	73
4322	71
4323	71
4324	71
4400	72
4401	72
4403	69
4404	69
4405	69
4410	72
4411	72
4413	69
4414	69
4415	69
4420	72
4421	72
4423	69
4424	69
4425	69
4442	122
4444	122
4701	74
4705	68
4706	68
4707	68
4711	74
4715	68
4716	68
4717	68
4721	74
4725	68
4726	68
4727	68

PRODUCT CODE	PAGE
4801	75
4802	75
4805	67
4806	67
4807	67
4808	66
4809	66
4810	66
4811	75
4812	75
4815	67
4816	67
4817	67
4818	66
4819	66
4820	66
4821	75
4822	75
4825	67
4826	67
4827	67
4828	66
4829	66
4830	66
4901	74
4911	74
4921	74
5005	127, 129
5007	127, 129
5015	87, 88
5021	89
5022	87, 88
5023	87, 88
5041	123
5042	123
5043	123
5044	123
5045	123
5046	123
5050	133, 135, 137, 141, 142, 143, 144, 145, 146, 147
5051	142, 143, 144, 145, 146, 147
5052	133, 135, 137, 141, 142, 143, 144, 145, 146, 147
5055	159
5056	159
5057	142, 143, 144, 145, 146, 147

PRODUCT CODE	PAGE
5059	133, 135, 137, 141, 142, 143, 144, 145, 146, 147
5100	89
5101	89
5102	90
5103	90
5104	90
5105	159
5106	159
5107	142, 143, 144, 145, 146, 147
5108	89
5109	133, 135, 137, 141, 142, 143, 144, 145, 146, 147
5110	133, 135, 137, 141, 142, 143, 144, 145, 146, 147
5111	142, 143, 144, 145, 146, 147
5112	133, 135, 137, 141, 142, 143, 144, 145, 146, 147
5114	90
5115	87, 88
5121	89
5122	87, 88
5123	87, 88
5141	123
5143	123
5150	89
5151	89
5152	90
5153	90
5154	90
5158	89
5164	90
5205	159
5206	159
5207	142, 143, 144, 145, 146, 147
5209	133, 135, 137, 141, 142, 143, 144, 145, 146, 147
5210	133, 135, 137, 141, 142, 143, 144, 145, 146, 147
5211	142, 143, 144, 145, 146, 147
5212	133, 135, 137, 141, 142, 143, 144, 145, 146, 147
5241	123
5243	123
5302	92, 93
5306	133, 135, 137, 141, 142, 143, 144, 145, 146, 147

PRODUCT CODE	PAGE	PRODUCT CODE	PAGE	PRODUCT CODE	PAGE
5308	94	7015	117	7211	162, 163, 164, 165
5312	92, 93	7041	121	7241	121
5316	133, 135, 137, 141, 142, 143, 144, 145, 146, 147	7042	121	7243	121
5318	94	7043	121	7360	114
5322	92, 93	7044	121	7361	114
5326	133, 135, 137, 141, 142, 143, 144, 145, 146, 147	7045	121	7365	114
5328	94	7046	121	7370	113
5352	92, 93	7050	162, 163, 164, 165	7371	113
5358	94	7051	168, 169	7375	113
5362	92, 93	7052	168, 169	7442	121
5368	94	7053	168, 169	7444	121
5442	123	7054	162, 163, 164, 165	7512	114
5444	123	7055	117	7522	113
5507	127, 129	7056	162, 163, 164, 165	7552	114
5607	127, 129	7057	115	7560	114
5801	127, 128	7058	162, 163, 164, 165	7561	114
5802	127, 128	7059	110	7562	113
5803	127, 128	7061	162, 163, 164, 165	7565	114
5804	127, 128	7070	115	7570	113
6020	116	7071	115	7571	113
6021	116	7075	115	7575	113
6025	116	7090	110	7612	114
6041	124	7091	110	7622	113
6042	124	7095	110	7670	115
6043	124	7100	162, 163, 164, 165	7671	115
6044	124	7101	168, 169	7675	115
6045	124	7102	168, 169	7707	115
6046	124	7103	168, 169	7710	110
6052	116	7104	162, 163, 164, 165	7757	115
6102	116	7105	117	7807	115
6141	124	7106	162, 163, 164, 165	7810	110
6143	124	7107	115	7850	110
6202	116	7108	162, 163, 164, 165	7990	110
6241	124	7109	110	7991	110
6243	124	7111	162, 163, 164, 165	7995	110
6442	124	7141	121	8001	109
6444	124	7143	121	8003	158
6620	116	7200	162, 163, 164, 165	8006	108
6621	116	7201	168, 169	8010	109
6625	116	7202	168, 169	8011	105, 106
6702	116	7203	168, 169	8012	106
6752	116	7204	162, 163, 164, 165	8013	105, 106
6802	116	7205	117	8014	106
7010	117	7206	162, 163, 164, 165	8016	108
7011	117	7207	115	8020	109
		7208	162, 163, 164, 165	8022	118
		7209	110	8026	108

PRODUCT CODE	PAGE
8030	158
8035	111, 149, 151, 153, 155, 157, 158
8040	158
8041	120
8042	120
8043	120
8044	120
8045	120
8046	120
8050	148, 150, 152, 154, 156
8051	149, 151, 153, 155, 157
8052	112
8053	112
8054	107
8056	149, 151, 153, 155, 157
8057	149, 151, 153, 155, 157
8058	148, 150, 152, 154, 156
8060	109
8061	108
8065	109
8066	108
8070	112
8071	112
8075	112
8080	107
8081	107
8085	107
8090	112
8091	112
8095	112
8100	148, 150, 152, 154, 156
8101	149, 151, 153, 155, 157
8102	112
8103	112
8104	107
8106	149, 151, 153, 155, 157
8107	149, 151, 153, 155, 157
8108	148, 150, 152, 154, 156
8110	133, 135, 137, 148, 150, 152, 154, 156
8111	105, 106
8112	106
8113	105, 106
8114	106
8120	148, 150, 152, 154, 156
8121	148, 150, 152, 154, 156

PRODUCT CODE	PAGE
8131	133, 135, 137, 141, 148, 150, 152, 154, 156
8135	111, 149, 151, 153, 155, 157, 158
8141	120
8143	120
8160	109
8161	133, 135, 137, 148, 150, 152, 154, 156
8166	108
8200	148, 150, 152, 154, 156
8201	149, 151, 153, 155, 157
8202	112
8203	112
8204	107
8206	149, 151, 153, 155, 157
8207	149, 151, 153, 155, 157
8208	148, 150, 152, 154, 156
8210	133, 135, 137, 148, 150, 152, 154, 156
8211	105, 106
8212	106
8213	105, 106
8214	106
8220	148, 150, 152, 154, 156
8221	148, 150, 152, 154, 156
8223	118
8224	118
8225	118
8226	118
8228	118
8229	105, 118
8231	133, 135, 137, 141, 148, 150, 152, 154, 156
8235	111, 149, 151, 153, 155, 157, 158
8241	120
8243	120
8261	133, 135, 137, 148, 150, 152, 154, 156
8323	95
8326	96
8350	96, 99, 101
8354	98
8355	96
8356	100
8357	99

PRODUCT CODE	PAGE
8358	97
8359	98
8360	100
8361	101
8363	101
8364	98
8365	99
8366	97
8367	95
8368	97
8369	95
8371	100
8372	100
8373	100
8375	95
8376	99
8377	99
8378	96
8379	96
8381	139
8382	139, 160
8383	139
8423	95
8426	96
8442	120
8444	120
8450	96, 99
8452	101
8454	98
8455	96
8456	100
8457	99
8458	97
8459	98
8460	100
8461	101
8463	101
8464	98
8465	99
8466	97
8467	95
8468	97
8469	95
8471	100
8472	100
8473	100
8475	95

PRODUCT CODE	PAGE	PRODUCT CODE	PAGE	PRODUCT CODE	PAGE
8476	99	8575	102	9442	125
8477	99	8578	102	9444	125
8478	96	8579	102	25050	214
8479	96	8580	102	54011	91
8481	139	8581	139	54012	91
8482	139, 160	8582	139, 160	54014	91
8483	139	8583	139	54511	91
8501	206	8681	139	54512	91
8502	206	8682	139, 160	54514	91
8503	206	8683	139	70053	114
8504	206	8703	204	70063	113
8505	206	8704	107	70511	166, 167
8506	206	8711	109	70512	166, 167
8510	133, 135, 137, 148, 150, 152, 154, 156	8713	204	70514	166, 167
8511	205	8716	108	70515	166, 167
8512	205	8801	204	71011	166, 167
8513	205	8802	204	71012	166, 167
8514	205	8803	182, 204	71013	114
8515	205	8804	107	71014	166, 167
8516	205	8811	109	71015	166, 167
8520	148, 150, 152, 154, 156	8816	108	71023	113
8521	148, 150, 152, 154, 156	8820	111	72011	166, 167
8523	102	8821	111	72012	166, 167
8531	133, 135, 137, 141, 148, 150, 152, 154, 156	8822	111	72013	114
8550	102, 103	8851	109	72014	166, 167
8551	103	8854	107	72015	166, 167
8552	103	8856	108	72023	113
8553	103	8900	240	76028	193
8554	102	8980	107	76029	193
8556	103	8981	107	76030	193
8557	103	8985	107	76031	193
8558	102	8990	109	76041	193
8559	102	8991	109	83223	238
8560	103	8995	109	83224	238
8561	133, 135, 137, 148, 150, 152, 154, 156	8996	108	83225	238
8564	102	8997	108	83226	237
8565	103	8998	108	83228	237
8566	102	9041	125	83229	237
8567	102	9042	125	83230	236
8568	102	9043	125	83231	236
8569	102	9044	125	86060	209
8572	103	9045	125	86068	191
8573	103	9046	125	86069	192
8574	103	9141	125	86077	189
		9143	125	86078	189
		9241	125	86079	189
		9243	125	86081	190

PRODUCT CODE	PAGE
86082	190
86084	239
86085	239
86086	239
86087	239
86088	191
86089	191
86090	191
86106	214
86144LH	192
86144RH	192
86147	234
86148	234
86149	234
86156	192
86160	191
86167	192
86168	192
86170	189
86180	191
86181	192
86182	192
86184	189
86187	181
86188	181
86189	181
86190	181
86191	181
86192	181
86193	181
86194	181
86343	188
86344	188
86345	187
86346	187
86347	188
86348	188
86349	188
86350	188
86351	187
86352	187
86436	190
86437	190
86439	191
86440	187
86441	187
86442	186

PRODUCT CODE	PAGE
86443	186
86444	187
86445	187
86480	189
86481	189
86621	187
86622	187
86628	187
86629	187
86640	187
86641	187
86674	188
86675	188
86693	186
86694	186
86711	186
86712	186
86721	186
86722	186
86910	188
86911	188
86912	188
86913	188
87001	186
87002	186
87003	186
87004	186
87005	186
87006	186
91013	226
91014	226
91023	226
91024	226
91033	226
91034	226
92013	227
92014	227
92015	227
92023	227
92024	227
92025	227
92033	227
92034	227
93223	238
93224	238
94013	228
94014	228

PRODUCT CODE	PAGE
94015	228
94023	228
94024	228
94025	228
94033	228
94034	228
95013	232
95014	232
95023	232
95024	232
95033	232
95034	232
96113	220
96114	220
96123	220
96124	220
96133	220
96134	220
96213	221
96214	221
96215	221
96223	221
96224	221
96225	221
96233	221
96234	221
96313	219
96314	219
96315	219
96413	222
96414	222
96415	222
96416	222
96425	222
97203	224
97204	224
97213	224
97214	224
97223	225
97224	225
97253	223
97254	223
97255	223
97256	223
97257	223
97263	223
97264	223

PRODUCT CODE	PAGE	PRODUCT CODE	PAGE	PRODUCT CODE	PAGE
97265	223	450721	77	460131	83
97266	223	450822	77	460212	82
97267	223	450923	77	460222	82
97273	223	451112	79	460232	82
97274	223	451211	79	461111	83
97275	223	451332	79	461121	83
97276	223	451411	78	461131	83
97277	223	451421	76	461212	82
97303	224	451512	78	461222	82
97304	224	451522	76	461232	82
97305	224	451613	78	462111	83
97313	224	451623	76	462121	83
97314	224	451721	77	462131	83
97315	224	451822	77	462212	82
97323	225	451923	77	462222	82
97324	225	452112	79	462232	82
97325	225	452211	79	470112	80
206011	206	452332	79	470222	81
206012	206	452411	78	470224	80
206016	206	452421	76	470333	81
206017	206	452512	78	471112	80
206511	206	452522	76	471222	81
206512	206	452613	78	471224	80
206516	206	452623	76	471333	81
220304	200	452721	77	472112	80
220404	202	452822	77	472222	81
220406	202	452923	77	472224	80
220408	202	453424	85	472333	81
220410	202	453525	85	9811332D	229
221710	190	453646	85	9811432D	229
221714	190	453727	85	9812332D	229
222201	171	453828	85	9812432D	229
222202	171	453929	85	9813332D	229
222203	171	454424	85	9813432D	229
222304	200	454525	85	9821332D	230
222307	200	454646	85	9821432D	230
222350	201	454727	85	9821532D	230
222351	201	454828	85	9822332D	230
450112	79	454929	85	9822432D	230
450211	79	455424	85	9823332D	230
450332	79	455525	85	9823432D	230
450411	78	455646	85	9841332D	231
450421	76	455727	85	9841432D	231
450512	78	455828	85	9841532D	231
450522	76	455929	85	9842332D	231
450613	78	460111	83	9842432D	231
450623	76	460121	83	9843332D	231

PRODUCT CODE	PAGE
9843432D	231
B110105	176, 178
B110106	176, 178
B110108	176, 178
B110110	176, 178
B110113	176, 178
B110116	176, 178
B110205	173, 177, 179
B110206	173, 177, 179
B110208	173, 177, 179
B110210	173, 177, 179
B110213	173, 177, 179
B110216	173, 177, 179
B120105	176, 178
B120106	176, 178
B120108	176, 178
B120110	176, 178
B120113	176, 178
B120116	176, 178
B120205	177, 179
B120206	177, 179
B120208	177, 179
B120210	177, 179
B120213	177, 179
B120216	177, 179
B130305	173
B130306	173
B130308	173
B130310	173
B130313	173
B130316	173
BSC001	173, 176, 177, 178, 179
CY4	240
E1000	40
E1001	40
E1020	40
E2000	41
E2001	41
E2020	41
E2200	41
E2201	41
E2220	41
E3002	40
E3020	40
E4002	41
E4010	38

PRODUCT CODE	PAGE
E4017	39
E4020	41
E4027	38
E4202	41
E4220	41
E4410	38
E4817	39
E4827	38
E401211	39
E451211	39
EMP20201	37
EMP20203	35
EMP20204	35
EMP20205	36
EMP20206	36
EMP20207	34
EMP20208	34
EMP21211	37
EMP21213	35
EMP21214	35
EMP21215	36
EMP21216	36
EMP21217	34
EMP21218	34
EMP22221	37
EMP22223	35
EMP22224	35
EMP22225	36
EMP22226	36
EMP22227	34
EMP22228	34
EMP23231	37
EMP23233	35
EMP23234	35
EMP23235	36
EMP23236	36
EMP23237	34
EMP23238	34
FS16	240
KEYDBEXT	40
KEYLVREXT	41
KIT-PRIV-103	239
KIT-PRIV-104	239
KIT-PRIV-106	239
LC4-DBLCH237R	235
LC4-DBLCH275R	235
LC4-DBLTCH237	235

PRODUCT CODE	PAGE
LC4-DBLTCH275	235
LC4-DLB275	235
LC4-DLB275R	235
LC4-DLB2375	235
LC4-DLB2375R	235
LC4-PAS28B237	236
LC4-PAS28B275	236
LC4-PASDV275	235
LC4-PASDV2375	235
LC4-PASS M 237	236
LC4-PASS M 275	236
LC4-PRIDB238	237
LC4-PRIDB275	237
LC4-PRIV M 237	236
LC4-PRIV M 275	236
LC4-PRV28B237	236
LC4-PRV28B275	236
LC4-PRVDV275	235
LC4-PRVDV2375	235
LC6-TUBPKTLATCH	237
LC9-DBLTCH237EMPWR	235
LC9-DBLTCH275EMPWR	235
MODULE-EMP2-YA	37
MODULE-WIFI-EMP2-YA	37
MP6-TUPKDUSTCVR	240
MS4-KEYBLKC	240
MS4-WEISERKYBLKC	240
S100	161
S200	161
S300	161
S800	117
S801	117
S802	117
S810	117
S811	117
S812	117
S901	91
S951	91
S3001	58
S3101	63
S3301	58
S3501	63
S40100	84
S40101	84
S50001	101
S50002	101
S50003	101

PRODUCT CODE	PAGE
S50004	101
S50023	101
S50024	101
S52005	103
S52006	103
S52007	103
S71001	214
S86002	189
THRDCY150	234
THRDCY175	234
THRDCY200	234
THRDCY1375	234
BRIDGE-WIFI-EMP2-YA	37
WIFI-BRIDGE-EMP2-YA	37
100PK-9FHWS75-B	233
100PK-9FHWS75-C	233
100PK-9FHWS75-FA	233
100PK-9FHWS75-FB	233
100PK-9FHWS75-MB	233
100PK-9FHWS75-N	233
100PK-9FHWS75-O	233
100PK-9FHWS75-P	233
100PK-9FHWS75-PN	233
100PK-9FHWS75-SB	233
100PK-9FHWS75-TWB	233
100PK-10FHWS10-B	233
100PK-10FHWS10-C	233
100PK-10FHWS10-FA	233
100PK-10FHWS10-FB	233
100PK-10FHWS10-MB	233
100PK-10FHWS10-N	233
100PK-10FHWS10-O	233
100PK-10FHWS10-P	233
100PK-10FHWS10-PN	233
100PK-10FHWS10-SB	233
100PK-10FHWS10-TWB	233
100PK-12FHWS13-B	233
100PK-12FHWS13-C	233
100PK-12FHWS13-FA	233
100PK-12FHWS13-FB	233
100PK-12FHWS13-MB	233
100PK-12FHWS13-N	233
100PK-12FHWS13-O	233
100PK-12FHWS13-P	233
100PK-12FHWS13-PN	233
100PK-12FHWS13-SB	233
100PK-12FHWS13-TWB	233

Door Hardware Order Form

Acct#

Order Placed By

Date

Billing Information

Company Name

Address

City State, Zip

Telephone

Shipping Address

Company Name

Address

City State, Zip

Telephone

PO#	Note
-----	------

QTY	Product / Rosette Code	Backset	Handle Style	Handing <small>(LH/RH)</small>	Door Thickness	Finish	Extension / Comments

**Please Fax Order Form to (800) 577-5771
or Email to orders@emtek.com**

LIFETIME LIMITED WARRANTY

Subject to the terms and conditions of this warranty, Emtek Products Group LLC ("Company") extends a lifetime limited warranty* to the original consumer user ("Original User") of our product ("Product") against defects in material and workmanship, as long as the Original User occupies the residential premises upon which the Product was originally installed.

**Electronic components warranted TWO (2) YEARS*

This warranty only applies to the Original User of the Products. This warranty is not transferable. This warranty applies to all products sold on or after April 2, 2012.

Original User: The Original User will return the defective Product to the retailer from whom it was purchased, accompanied by a statement of defects and proof of purchase.

What Emtek will do: Upon return of the defective Product to Emtek for inspection, free and clear of all liens and encumbrances and accompanied by the statement of defects and proof of purchase, Emtek's sole obligation, at its option, is to either repair or replace the Product, or refund the original retailer purchase price in exchange for the Product.

THE COMPANY MAKES NO OTHER WARRANTY OTHER THAN AS EXPRESSLY STATED HEREIN, AND ALL IMPLIED WARRANTIES, INCLUDING ANY WARRANTY OF MERCHANTABILITY OR FITNESS FOR A PARTICULAR PURPOSE, ARE HEREBY EXCLUDED.

THE COMPANY'S MAXIMUM LIABILITY HEREUNDER IS LIMITED TO THE PURCHASE PRICE OF THE PRODUCT. IN NO EVENT SHALL THE COMPANY BE LIABLE FOR ANY CONSEQUENTIAL, INDIRECT, INCIDENTAL OR SPECIAL AND/OR PUNITIVE DAMAGES OF ANY NATURE ARISING FROM THE SALE OR USE OF THE PRODUCT, WHETHER BASED ON CONTRACT, WARRANTY, TORT, STRICT LIABILITY, PATENT INFRINGEMENT, OR OTHERWISE, EVEN IF ADVISED OF THE POSSIBILITY OF SUCH DAMAGES. Some local laws do not allow the exclusion or limitation of incidental or consequential damages, so the above exclusion or limitation may not apply to you. This warranty gives specific legal rights and a buyer may also have other rights which may vary from state to state.

WHAT IS NOT COVERED: THE FOLLOWING COSTS, EXPENSES AND DAMAGES ARE NOT COVERED BY THE PROVISIONS OF THIS LIMITED WARRANTY: (I) LABOR COSTS INCLUDING, BUT NOT LIMITED TO, SUCH COSTS AS THE REMOVAL AND RE-INSTALLATION OF PRODUCT; AND (II) SHIPPING AND FREIGHT EXPENSES REQUIRED TO RETURN PRODUCT TO EMTEK.

THE PROVISIONS OF THIS WARRANTY DO NOT APPLY TO PRODUCTS: (I) USED IN COMMERCIAL APPLICATIONS; (II) USED IN COMMON AREA APPLICATIONS; (III) USED FOR PURPOSES FOR WHICH THEY ARE NOT DESIGNED OR INTENDED; (IV) WHICH HAVE BEEN SUBJECTED TO ALTERATION, ABUSE, MISUSE, NEGLIGENCE OR ACCIDENT; (V) WHICH HAVE BEEN IMPROPERLY STORED, INSTALLED, MAINTAINED OR OPERATED; (VI) WHICH HAVE BEEN USED IN VIOLATION OF WRITTEN INSTRUCTIONS PROVIDED BY EMTEK; (VII) WHICH HAVE BEEN SUBJECTED TO IMPROPER TEMPERATURE, HUMIDITY OR OTHER ENVIRONMENTAL CONDITIONS; OR (VIII) WHICH, BASED ON EMTEK'S EXAMINATION, DO NOT DISCLOSE TO EMTEK'S SATISFACTION NON-CONFORMANCE TO THE WARRANTY. Additionally, this warranty DOES NOT COVER scratches, abrasions, or deterioration due to the use of paints, solvents or other chemicals.

Finish Warranty: Polished Brass-Lifetime and Polished Nickel-Lifetime finishes carry a lifetime limited finish warranty. There is no finish warranty on Deep Burgundy, Flat Black Patina, Medium Bronze Patina, Polished White Bronze, Rust, Silver Patina, Tumbled White Bronze and Unlacquered Brass finishes. All other finishes carry a five-year finish warranty.

Emtek SELECT Lever and Knob(s) with Marble, Terrazzo, and Walnut handles feature a living finish that will age gracefully and evolve over time, enhancing the character of your space. Due to this unique characteristic, no finish warranty is offered on these products. All SELECT lever and knobs featuring Marble, Terrazzo and Walnut are intended for indoor use.

Warranty claims: Please contact the retailer from whom the defective product was purchased. If assistance is needed, please contact Emtek Customer Service at:

EMTEK Products Group LLC
Tel: (800) 356-2741

EMTEK®

EMTEK Products
Tel: 800-356-2741
Fax: 800-577-5771
emtek.com